

- 1976 **Company Founded**
- 1980 **First Production 20 m²**
- 1980 **Automotive Spare Parts Production**
- 1985 **Motocycle Helmet Manufacturing**
- 1994 **Establishment of Albatur A.S.**
- 1996 **New Factory at Duacinari 650 m²**
- 2002 **New Factory 2.000 m²**
- 2003 **Starting of Sliding System Manufacturing**
- 2004 **Product Patent**
- 2005 **albaturas.com is Online**
- 2005 **International Fair Experience (Romania Fair)**
- 2006 **Export**
- 2007 **Domestic Fair Experience (Intermob / Istanbul)**
- 2008 **ISO 9001:2008**
- 2008 **Albatur Catalogue**
- 2009 **Product Testing Unit Started Operations**
- 2011 **Assembly Videos**
- 2013 **Corporate Identity**
- 2015 **Interzum Fair**
- 2015 **Albatur 2 Started Operations**
- 2016 **ERP System is Installed**
- 2017 **Electricity Generation with Solar Energy System**
- 2019 **Industry 4.0 Investments**
- 2019 **Albatur 3 Started Operations**
- 2021 **Albatur Under One Roof**



**Effective, Reliable,
Solution-Oriented**

Bursa / TURKEY

As a leading sliding systems brand in Turkey, we operate on an 11,000 m² facility in Bursa, producing high-quality products with our team of over 100 experienced professionals. While maintaining our impact in the domestic market by collaborating with more than 300 business partners, we have achieved global success by exporting to over 87 countries across 5 continents.



Sliding Folding Door and Cover Systems



Wardrobe Hardware



Door Hardware

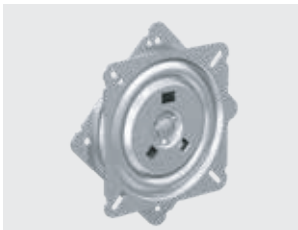

Turntable Equipments



Decorative Vents

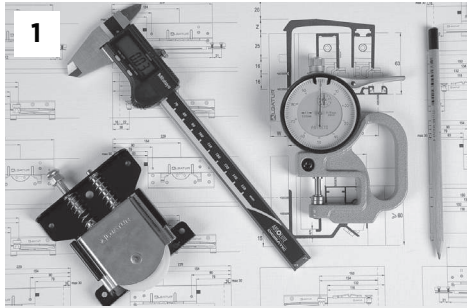

1
Quality Management



2
R-D

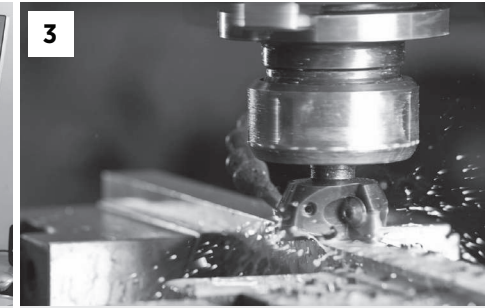

3
Mold



4
Production



5
Product Testing

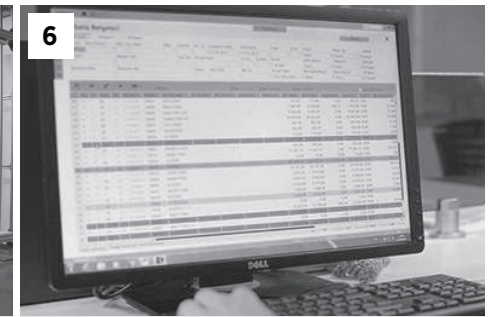

6
ERP Process Management

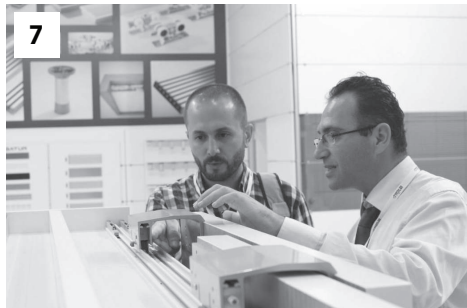

7
Sales and Marketing



8
Export



9
Certification



With our core principle of maximizing customer satisfaction and achieving zero-defect production, all processes from raw material intake to the delivery of the final product are meticulously measured and controlled by our team of specialized and dynamic quality engineers. Our company is committed to preventing errors before they occur, rather than correcting them after the fact. In line with this approach, we aim to maintain the highest quality standards through continuous improvement and innovative practices. This mindset allows us to exceed customer expectations and distinguish ourselves in the industry.

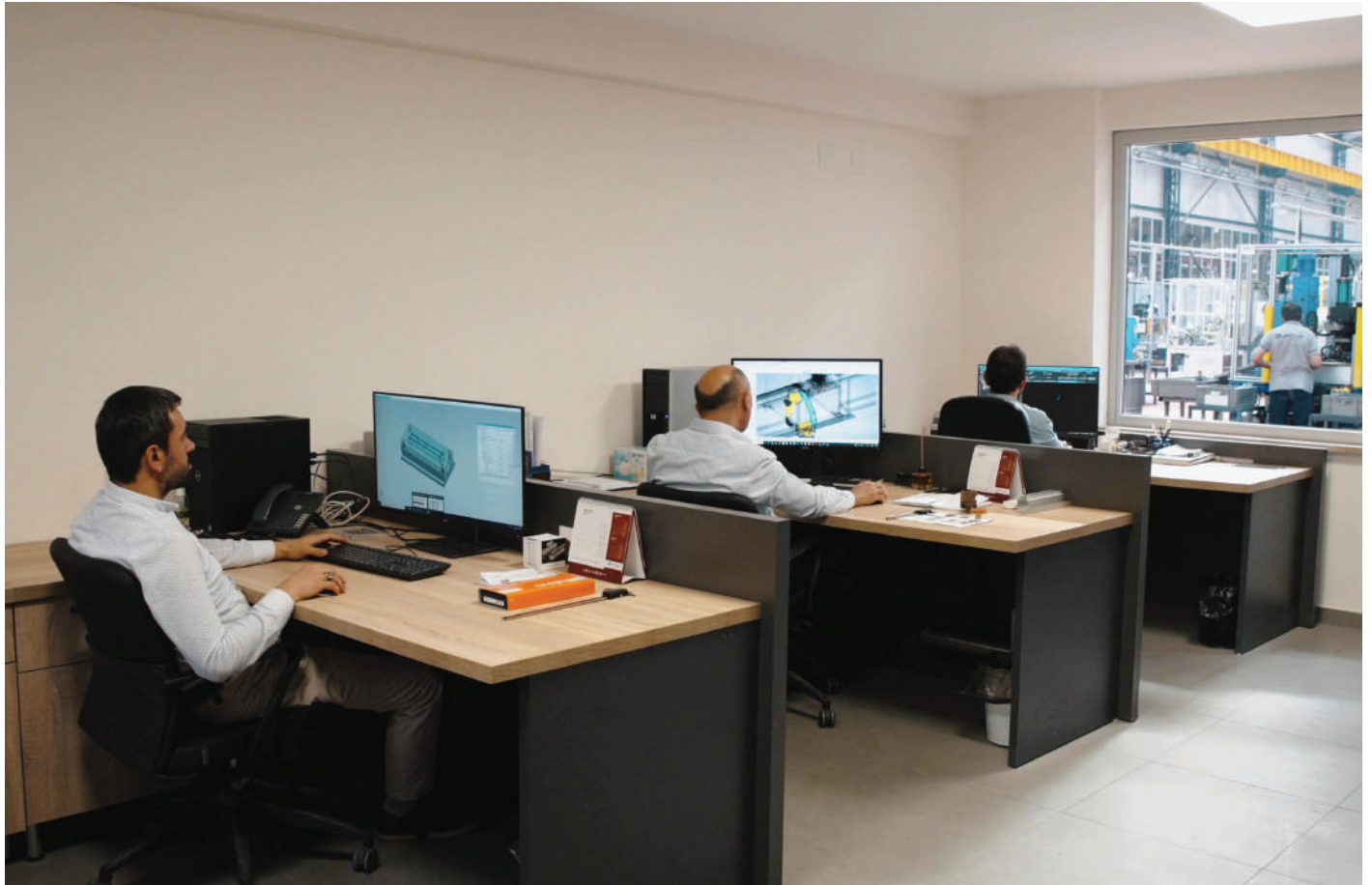

With our professional R&D team, we continue our efforts to enhance your living comfort to the highest level. By integrating evolving and changing technologies into our R&D and innovation activities, we aim to be a pioneer of innovation in the industry. In line with our principle of continuous development and excellence, we are dedicated to improving our existing products and developing brand-new, innovative solutions. Our customer-focused approach, quick adaptation to industry innovations, and effective use of technology allow us to offer you the highest quality and most innovative products. In this context, we continually renew ourselves and closely follow global developments to develop the most suitable, effective, and sustainable solutions for your needs. In our R&D efforts, we prioritize quality and performance, striving to provide the best to our customers.



The mold design and mold production processes of our products are meticulously carried out in-house by our experienced and technically knowledgeable expert personnel, using our state-of-the-art machinery. From the design phase to the end of the production process, we adhere to high-quality standards at every step, achieving results that exceed customer expectations thanks to our technological infrastructure and expert team. With this integrated approach, we ensure excellence and efficiency at every stage of the production process, while also offering flexible and innovative solutions to best meet our customers' needs.



With our extensive and modern machinery park, including plastic injection machines, eccentric presses, hydraulic presses, static and wet painting facilities, surface treatment machines, CNC machining centers, aluminum mechanical processing facilities, assembly automations, and robotic arms, all processes from the design to the shipment of our products are meticulously carried out within Albatır. By increasing the level of automation in our production lines with our robotic arms, we maximize both efficiency and production speed. Thanks to our comprehensive and advanced technology infrastructure, we maintain control over every stage of production, upholding our high-quality standards and aiming to ensure maximum customer satisfaction. At Albatır, our integrated production systems allow us to gain both flexibility and speed, continuously enhancing our competitive strength in the industry.



Before our products reach our customers, they undergo all necessary technical tests during the prototype stage at our in-house testing center. These tests are meticulously conducted to ensure the durability, performance, and compliance of our products with quality standards. Only products that successfully pass this testing process are included in our product lines and moved to production. Through this comprehensive testing and evaluation process, we fulfill our commitment to always provide our customers with the highest quality and most reliable products.



Our production and sales processes are closely monitored and managed with the IAS Canias ERP program. Thanks to this system, which is integrated into all our processes, traceability, tracking, and reporting are effectively carried out using barcodes. This allows us to optimize our processes and increase efficiency by monitoring real-time data at every stage, from production to shipment. Additionally, this comprehensive tracking and reporting capability enables us to continuously improve our processes and respond to customer demands more quickly and effectively.



With over 300 exclusive sales points across Turkey, we provide our products to the furniture industry. Thanks to our extensive sales network and strong distribution channels, we offer easy access and fast delivery to our customers in the furniture sector. Our sales points throughout Turkey play a crucial role in delivering the highest quality products to our customers quickly. With this widespread and effective sales network, we aim to offer our solutions to the furniture industry while maintaining the highest level of customer satisfaction.



As of the end of 2024, Albatur-branded products are exported to more than 87 countries in the international market. Thanks to this extensive export network, we continue to grow globally, bringing our products to customers all around the world. At Albatur, with the experience and reliability we have gained in international markets, we continue to reach more countries each day, representing our brand and the quality of our products at a global level. This success is a result of both our customer satisfaction-focused approach and our high-quality production processes.



Aware that development requires a systematic approach, our organization meticulously fulfills the requirements of the ISO 9001:2015 Quality Management System and undergoes regular audits by TÜV Intercert to renew our certification. Additionally, our certifications include the TSE EN 1527 product standard, CE certification, ISO 10002:2018 Customer Satisfaction Management System, ISO 45001:2018 Occupational Health and Safety Management System, and ISO 14001:2015 Environmental Management System. We continuously monitor and improve high standards in quality, safety, environment, and customer satisfaction with these certifications. They allow us to consistently review our processes and follow best practices in the industry, ensuring that our product and service quality remains at the highest level.



Assembly Installation Videos



Product Display Stands



Exhibitions



albaturas.com



SetBox



You can watch our 3D assembly videos and live product videos on our website, albaturas.com, as well as on our Youtube, Dailymotion, Vimeo pages.



We provide our display stands to our dealers so that end-users and furniture companies can experience our products.



Through international and domestic trade fairs, we have the opportunity to share and showcase our innovations with our customers more closely. These fairs allow us to present the latest industry developments, product innovations, and technological advancements directly to our target audience, providing us with immediate feedback and enabling us to stay updated on market trends.

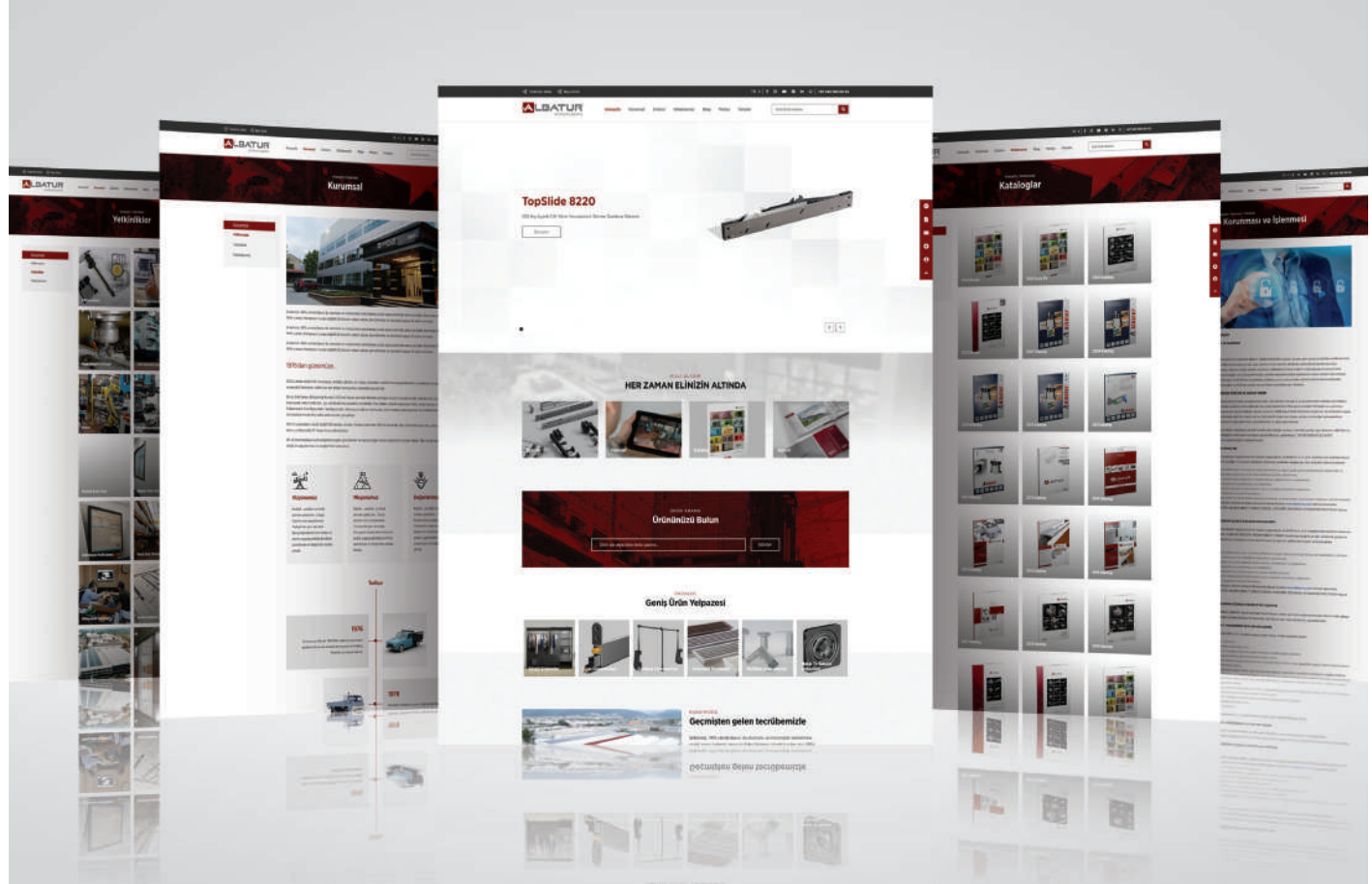

You can easily access technical and detailed information about all our products, assembly videos, and updates through our continuously updated website, albatas.com.



The Setbox packaging includes the mechanism, aluminum rail profiles, assembly kit, and installation diagram. This packaging is organized into a single specially designed box with protective foam, arranged as a complete cabinet set. This design prevents confusion of the components and minimizes damage during transportation. Additionally, the sturdy structure and organized interior layout of the packaging provide significant convenience during the assembly and installation process. The Setbox packaging aims to optimize both logistics and user experience, thereby enhancing customer satisfaction.

Coplanar [®]	Coplanar Sliding Wardrobe Series	Grup 101
TopSlide [®]	Sliding Wardrobe Series	Grup 102
Multiline [®]	Sliding Door Series	Grup 103
WingSlide [®]	Sliding Foldable Door Series	Grup 105
Glassline [®]	Sliding Glass Door Series	Grup 108
Rigel [®]	Sliding Rail Wardrobe Series	Grup 109
TvSlide [®]	Sliding Tv Unit Series	Grup 110
Softline [®]	Soft Closers Series	Grup 117
Pulltens [®]	Pull & Tension Series	Grup 118
BarnDoor [®]	BarnDoor Sliding Door Series	Grup 119
DoorSlide [®]	Wooden Sliding Door Series	Grup 120

DoorSync [®] Wood	Wooden Funicular Sliding Door Series	Grup 121
MasterFold [®] MidFold [®]	Wooden Foldable Sliding Door Series	Grup 122
GlassDoor [®]	Glass Door Sliding Series	Grup 123
DoorSync [®] Glass	Funicular Glass Door Series	Grup 124
MultiDoor [®]	Telescopic Wooden Sliding Door Series	Grup 127
Underline [®]	Door Hardware Series	Grup 130
MagicLift [®]	Wardrobe Equipments Series	Grup 135
Ventil [®] Aluminium	Aluminium Air Ventilation Cover Series	Grup 140
Ventil [®] Plastic	Plastic Air Ventilation Cover Series	Grup 141
TurnTable [®]	Swivel Plate - Turnable Table Series	Grup 142
Feet	Furniture Feet Series	Grup 144

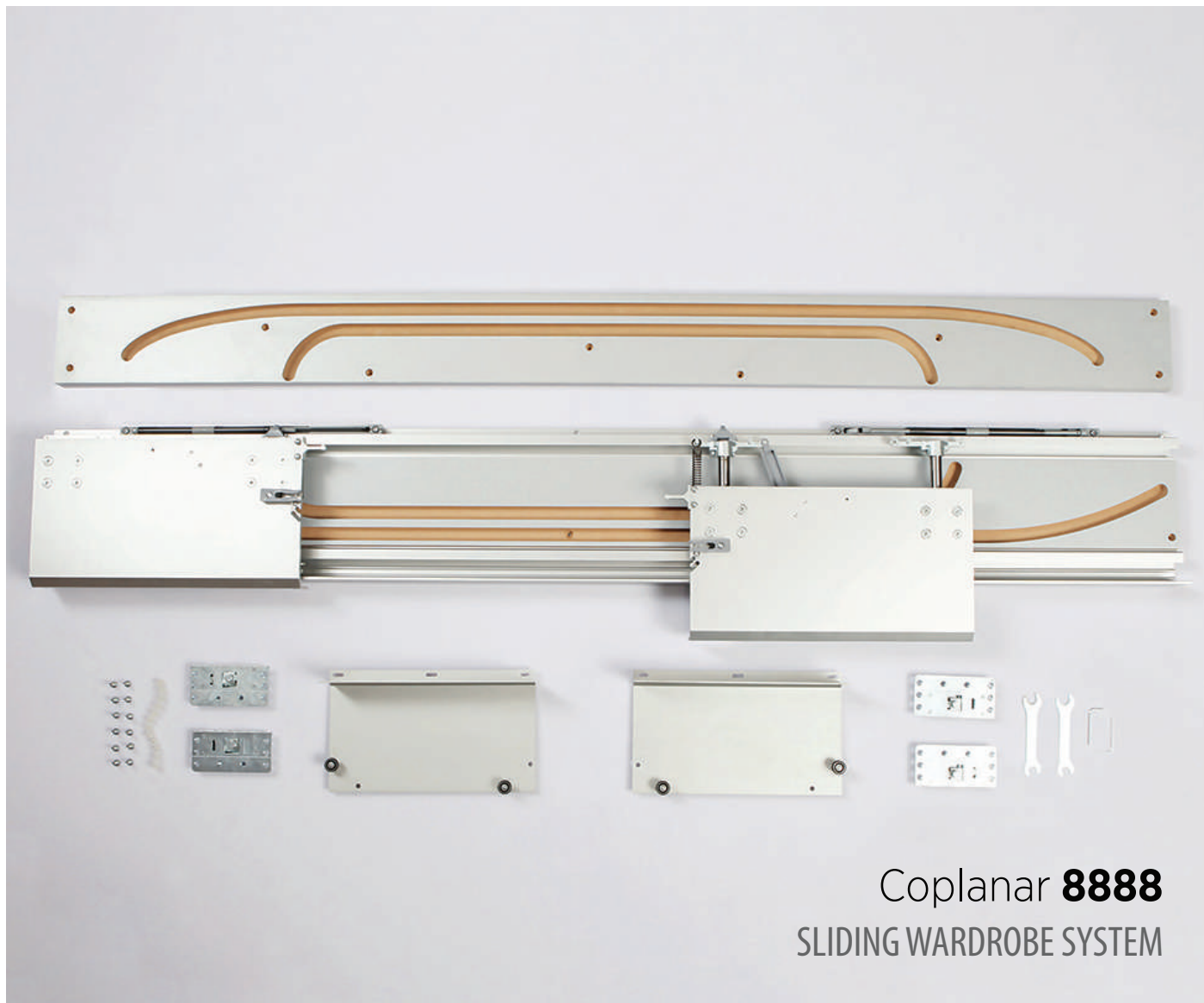

Coplanar **8888**
SLIDING WARDROBE SYSTEM

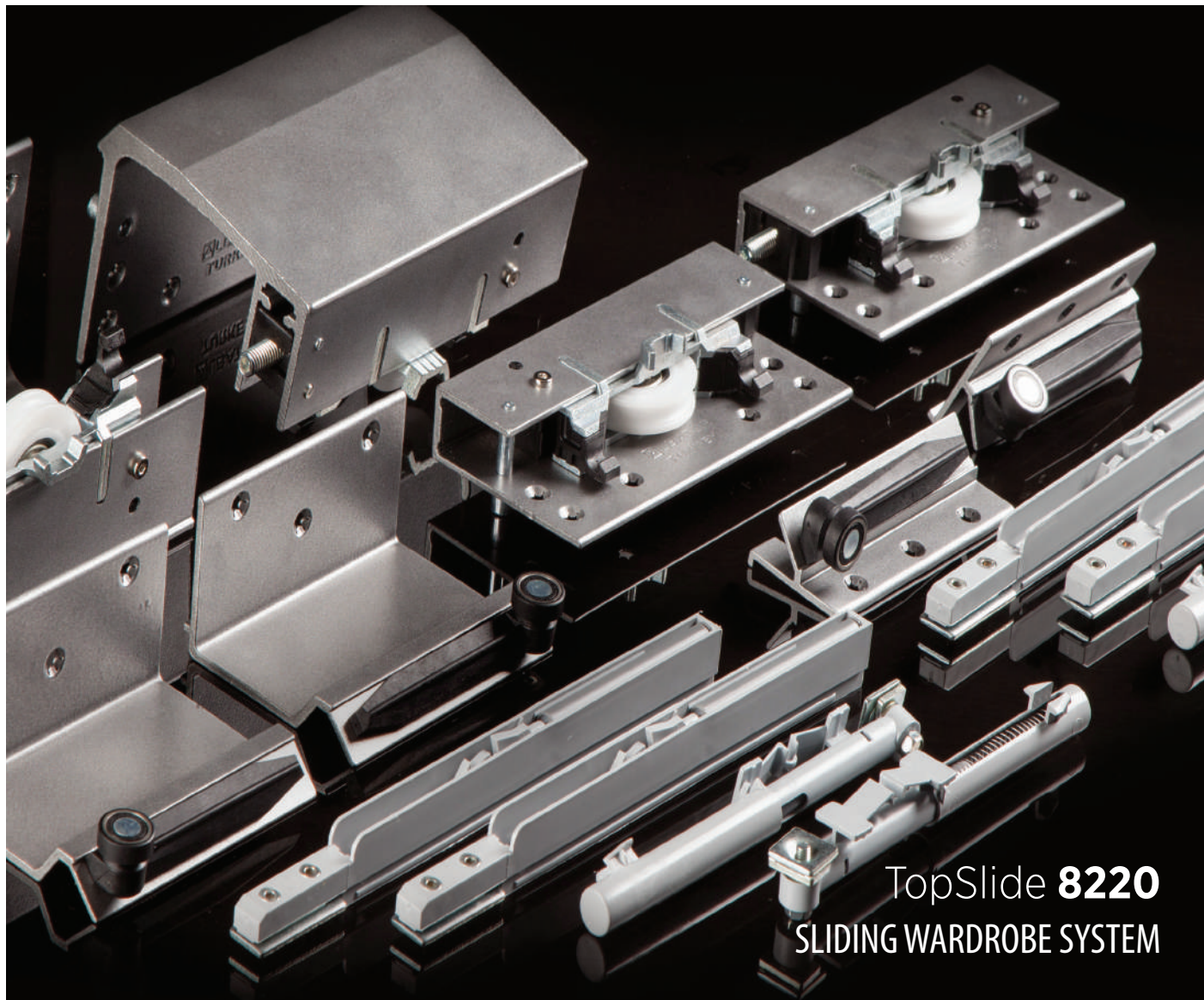

TopSlide **8220**
SLIDING WARDROBE SYSTEM

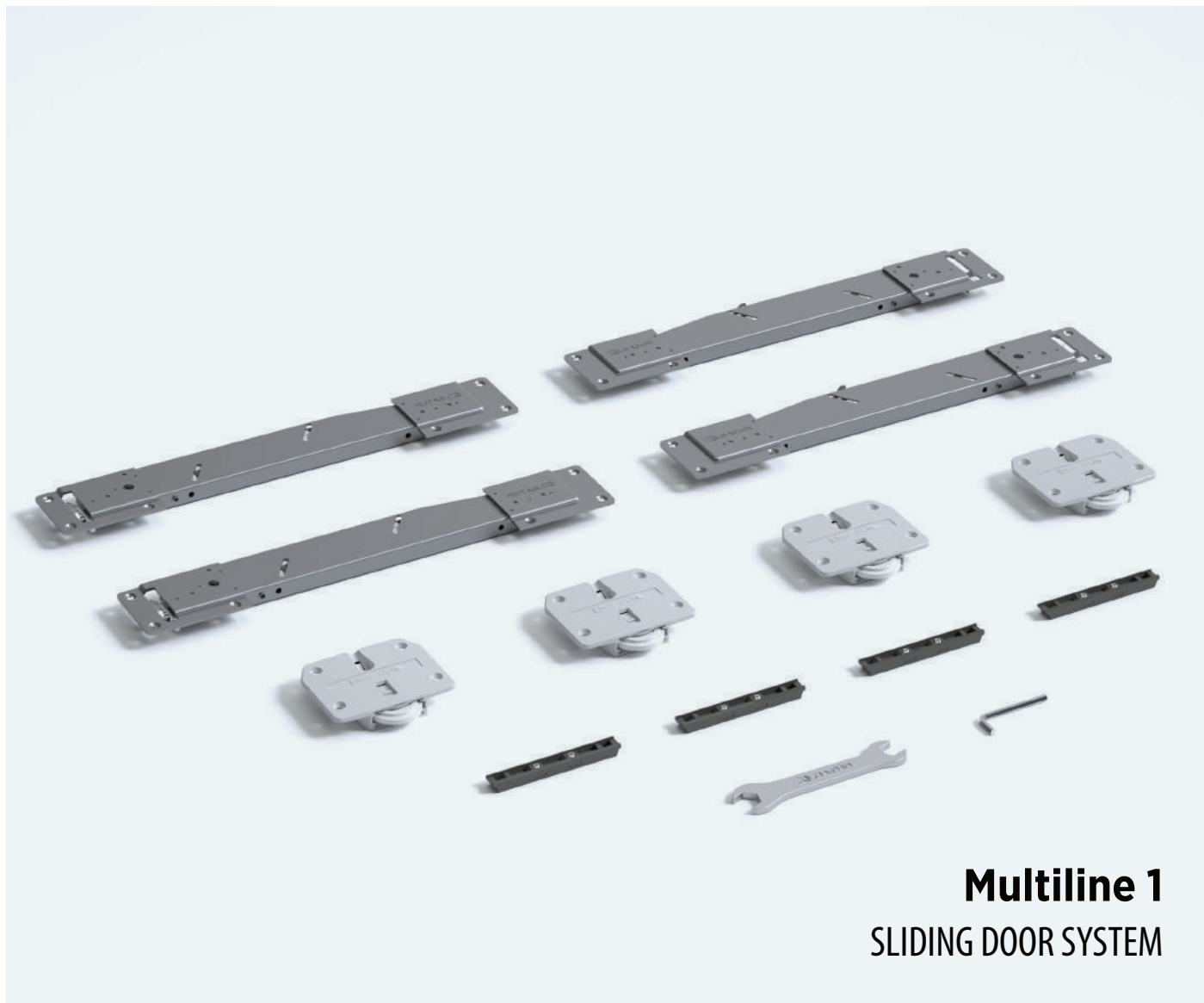

Multiline 1
SLIDING DOOR SYSTEM

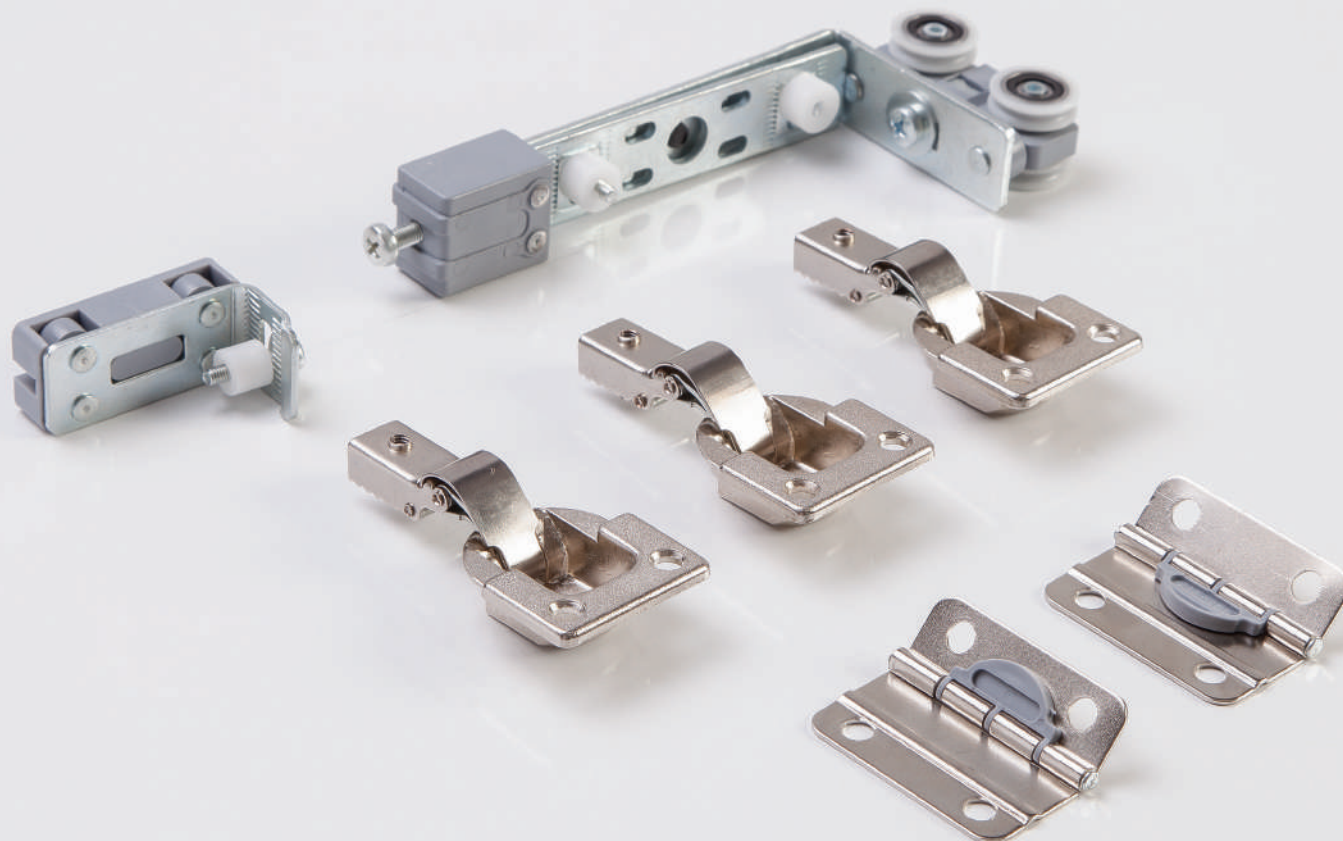

WingSlide 7440
40 KG SLIDING SYSTEM FOR FOLDING DOORS



Glassline 7700
25 KG GLASS DOOR SLIDING SYSTEM



Rigel 1

50 KG SLIDING PANEL SYSTEM



TvSlide 5100

45 KG TV UNIT SLIDING DOOR SYSTEM



Softline Serisi
SOFT CLOSER SYSTEM



Pulltens 11
PULL & TENSION METAL



BarnDoor 8820

80 KG SLIDING DOOR SYSTEM - TWO WAY SOFT CLOSING





DoorSync® 9840

60 KG FUNICULAR SLIDING DOOR SYSTEM - HAS SOFT CLOSING



MasterFold[®]

WOODEN FOLDABLE SLIDING DOOR SERIES



MidFold[®]

WOODEN FOLDABLE SLIDING DOOR SERIES



GlassDoor[®]

GLASS DOOR SLIDING SERIES





MultiDoor[®]

TELESCOPIC WOODEN SLIDING DOOR SYSTEMS



Underline[®]
DOOR SEAL - INTERNAL



MagicLift[®]

WARDROBE EQUIPMENTS SERIES

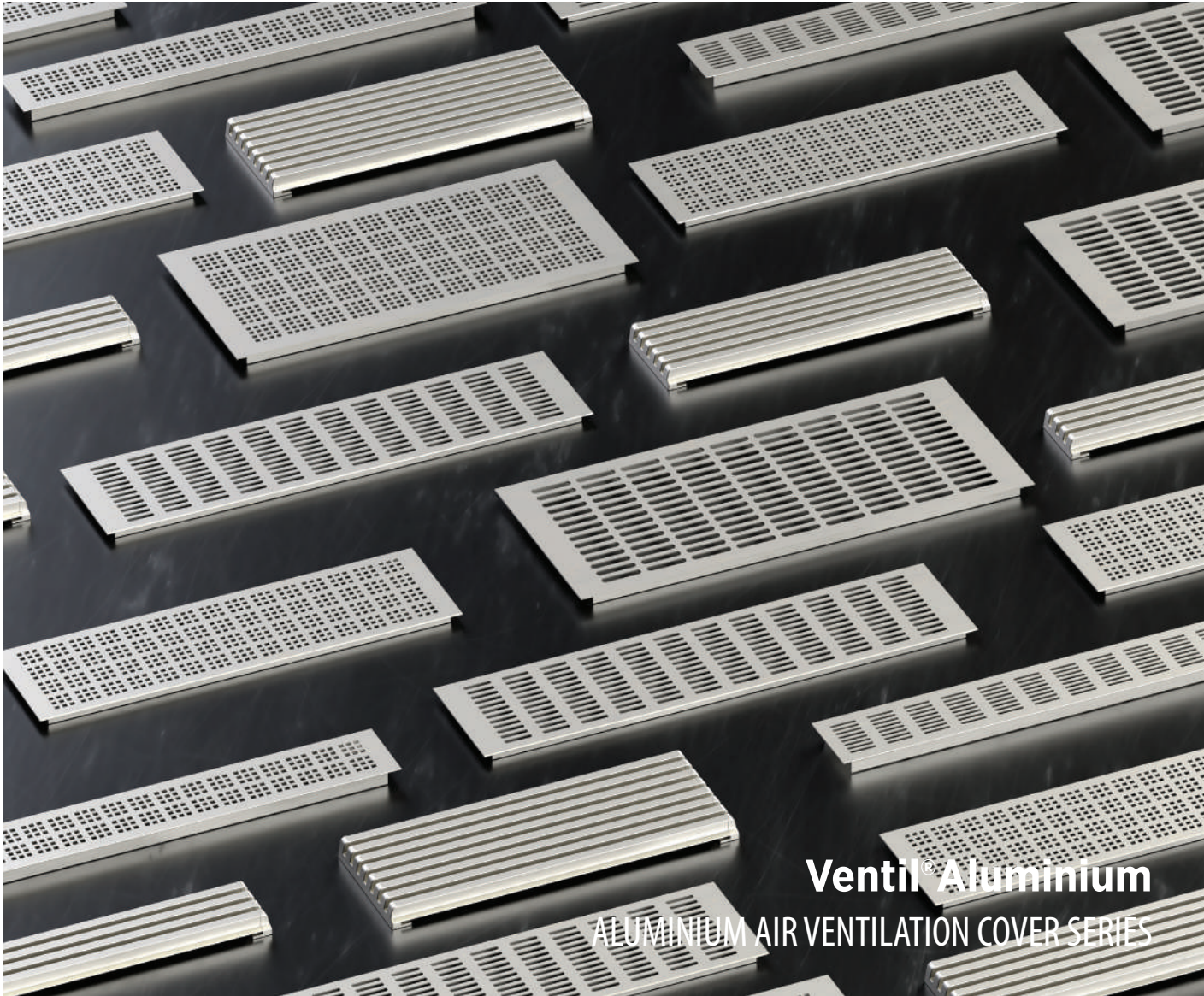

Ventil® Aluminium

ALUMINIUM AIR VENTILATION COVER SERIES



Ventil®Plastic

PLASTIC AIR VENTILATION COVER SERIES



TurnTable[®]

SWIVEL PLATE - TURNABLE TABLE SERIES

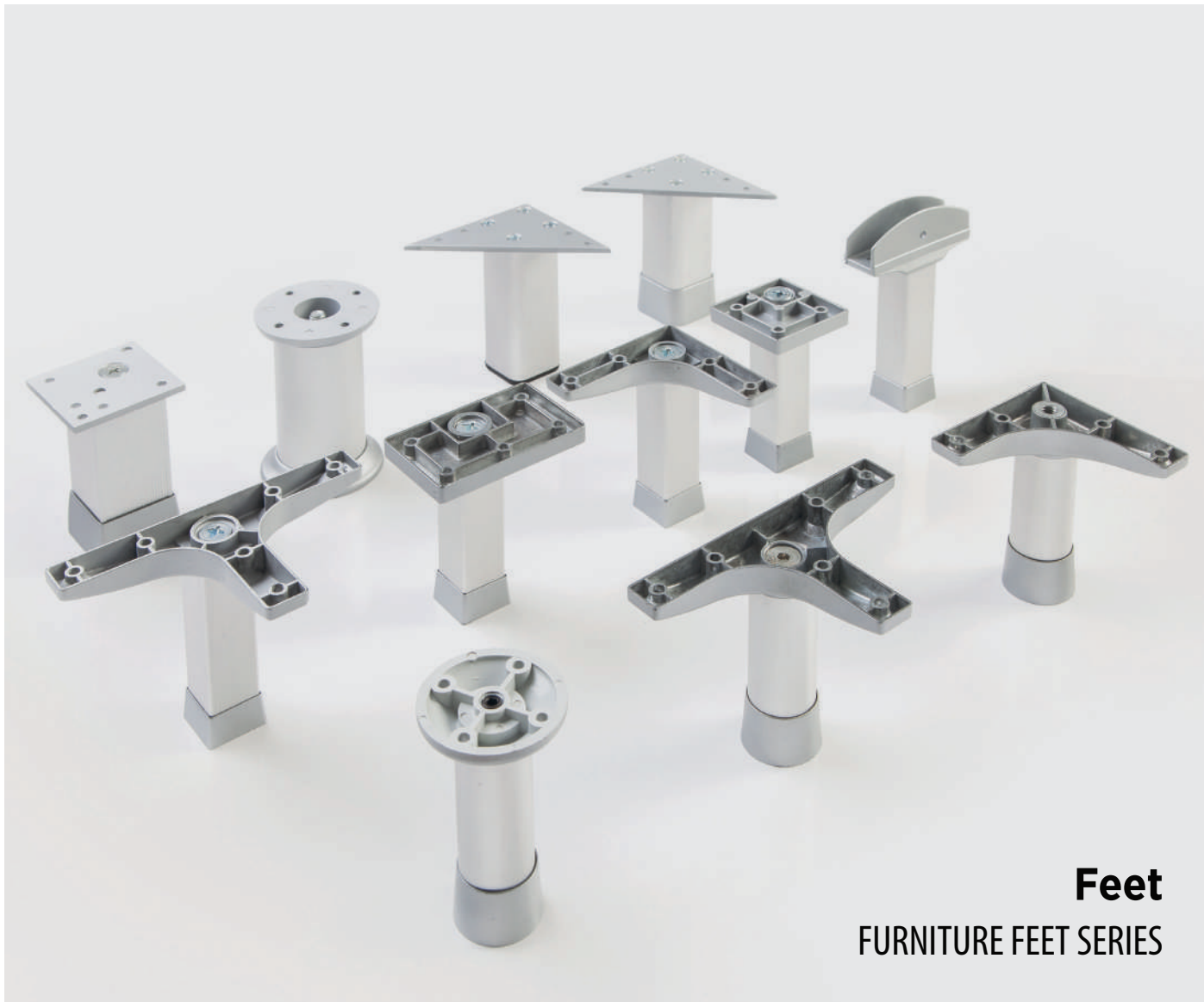

Feet
FURNITURE FEET SERIES



facebook.com/**albaturas**



youtube.com/**albaturas**



instagram.com/**albaturas**



albaturas.com



We support the use of environmentally friendly energy resources with our investments.



Our Brands



-1-



The
Sliding
System



TurnTable®

Pulltens®

Multiline®

WingSlide®

GlassDoor®

MultiDoor®

BarnDoor®

-2-

Glassline[®]

DoorSlide[®]

TvSlide[®]

Rigel[®]

Coplanar[®]

Softline[®]

DoorSync[®]

Underline[®]

TopSlide[®]

MasterFold[®]

MagicLift[®]

Ventil[®]

 **HINGETECH**
Hinge Technology

Feet[®]

Momentum[®]

Interline[®]

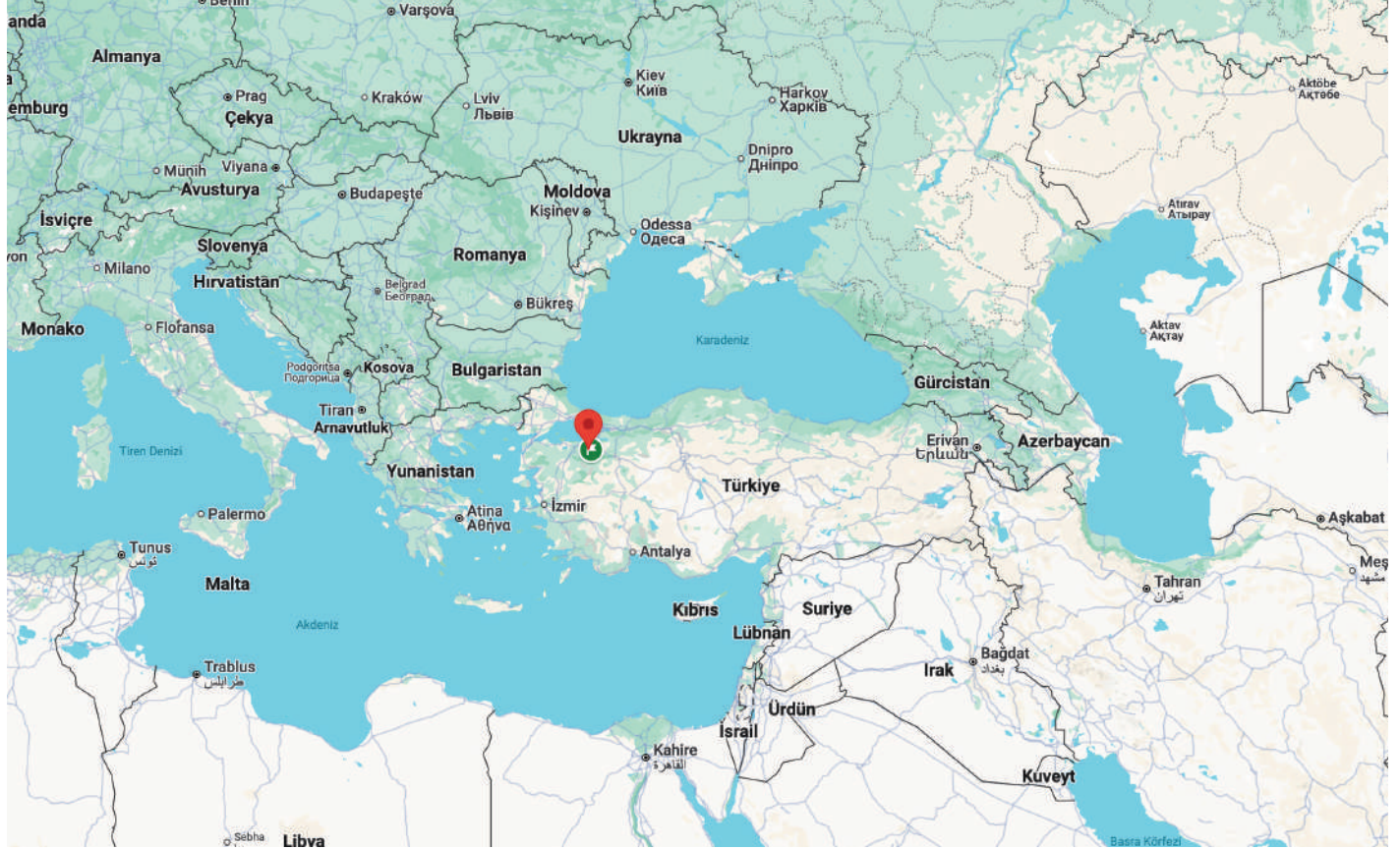

Albatur Endüstri A.Ş.

Alaaddinbey Cd. No.118 Çalı / Nilüfer / BURSA / TÜRKİYE

Tel : +90 224 482 46 75 Faks : +90 224 482 46 77

E-mail : info@alaturas.com

Web : alaturas.com

Türkiye

Discover
the potential



SINCE
1976



Bearing
Systems

EN 1527
100.000
CYCLES
TEST



R
The
Sliding
System

alaturas.com