

SINCE
1976

Bu katalogtaki tüm telif hakkı Albatır Endüstri A.Ş. aittir. Yazılı izin olmadan tam yada kısmen kopyalanamaz veya çoğaltılamaz. Tüm detaylarda ve teknik konularda deęişiklik yapma hakkı saklıdır. Ürünlerimiz faydalı model ve endüstriyel tasarım belgeleri ile tescillenmiştir.

All rights in this catalog reserved by Albatır Endüstri A.Ş. no part of this publication may be reproduced or copied without any written permission. All technical details are subject to change. Our products are registered with utility model and industrial design documentations.

Katalogtaki ürün sayfalarında verilen teknik ölçüler bağlayıcı değildir. Önerilen kurulum ölçüleridir. Albatır ürün özelliklerinde haber vermeden deęişiklik yapabilir.

Technical dimensions are not binding given in the catalog. They are recommended installation sizes. Albatır can make modification on the products features without any notice.

Tipografik hatalardan firmamız sorumlu değildir.
Our company is not responsible for typographic fault.

Hakkımızda

ABOUT US



Albatür Endüstri A.Ş.'nin 1976 yılında Bursa'da başlayan yolculuğu, bugün Türkiye'nin önde gelen sürgü sistem markalarından biri olarak devam etmektedir. Farklı sektörlerle üretici kimliğiyle hizmet veren firmamız, 2003 yılından itibaren sürgülü ve katlanır kapı ile kapak sistemlerine odaklanmıştır.

49 yıllık üretim tecrübesine sahip olan Albatür, Bursa'nın Nilüfer ilçesindeki 11.000 m² alana sahip, çevreye duyarlı modern tesislerinde üretim yapmaktadır. Tüm üretim süreçlerimizi; ar-ge, tasarım, kalıp, sac şekillendirme, presleme, plastik enjeksiyon, CNC işleme, boya, alüminyum işleme, montaj ve robot otomasyonu dâhil olmak üzere kendi bünyemizde gerçekleştirmekteyiz. Bu süreçler, alanında uzman mühendislerimizin titiz denetimi altında yürütülmektedir.

Albatür, geliştirdiği yenilikçi ürünlerle yaşam alanlarını genişletirken, ileri teknolojik çözümleriyle müşteri memnuniyetini en üst düzeye çıkarmayı hedeflemektedir. İç pazarda 300'den fazla aktif iş ortağı ve beş kıtada 87'den fazla ülkeye gerçekleştirdiği ihracat ile Albatür, hem Türkiye'de hem de dünyada mobilya aksesuarlarında yaşamı zenginleştiren çözümler sunmaktadır.

Bu yolculukta yanımızda olan değerli iş ortaklarımıza, paydaşlarımıza, çalışanlarımıza, ürünlerimizi tercih eden müşterilerimize ve bizlere destek veren herkese içtenlikle teşekkür ederiz.

The history of Albatür Endüstri A.Ş., which began in Bursa in 1976, continues today as one of Turkey's leading sliding system brands. Serving various sectors with our identity as a manufacturer, we have focused on sliding and folding door and cabinet systems since 2003.

With 49 years of production experience, Albatür manufactures its products in its eco-friendly, modern facilities located on an 11,000 m² site in the Nilüfer district of Bursa. We manage all of our production processes in-house, including R&D, design, molding, sheet metal forming, pressing, plastic injection, CNC machining, painting, aluminum processing, assembly, and robotic automation. These processes are meticulously supervised by our team of expert engineers.

Albatür not only expands living spaces with its innovative products but also aims to maximize customer satisfaction through cutting-edge technological solutions. With over 300 active partners in the domestic market and exports to more than 87 countries across five continents, Albatür offers solutions that enrich life through furniture accessories both in Turkey and globally.

We sincerely thank our valued business partners, stakeholders, employees, customers who choose our products, and everyone who supports us on this journey.

Çevre Politikamız

ENVIRONMENTAL POLICY



Albatur Endüstri A.Ş., yürüttüğü tüm faaliyetlerde çevrenin korunmasını, sürekli iyileştirmeyi, doğal kaynakların etkin kullanılmasını, yasalara tam uyum ve kirliliğin önlenmesini, faaliyetleri sırasında oluşan atıkların öncelikli olarak kaynağında azaltılmasını ve ayrıştırılmasını, geri dönüşüme kazandırılmasını, en uygun yöntemlerle bertaraf edilmesini çevre politikasının temeli kabul eder.

Bu politika çerçevesinde ;

- Faaliyetlerimizin çevresel boyutlarını belirlemeyi, etkilerinin türlerini ve zararlarını tespit ederek çevresel etkileri en aza indirmek için en iyi yöntem ve teknolojileri kullanmayı,
- Çalışanlarımızı, tedarikçilerimizi ve taşeronlarımızı çevrenin korunması konusunda bilinçlendirmek amacıyla eğitim faaliyetleri düzenlemeyi,
- Mümkün olduğu kadar yenilenebilir enerji kaynaklarını seçip, doğal kaynakları verimli kullanmayı,
- Çevresel kirliliği önlemek amacıyla, yasal, uluslararası mevzuatları takip etmeyi ve bunlara uyum sağlayarak çevre performansını sürekli iyileştirmeyi görev edinmiştir.

Gelecek nesillere yaşanılabilir bir dünya bırakmanın sorumluluk olduğu düşüncesiyle, Albatur olarak üretimde kullandığımız elektriği güneş enerjisinden elde ediyoruz.

Albatur Industry Inc. adopts the environmental policy in all activities it carries out, continuous improvement, effective use of natural resources, full compliance with the law and prevention of pollution, reduction and separation of the wastes generated during its operations at the source, recycling and recycling with the most appropriate methods.

Within of this policy;

















- Using the best methods and technologies to minimize environmental impacts by identifying environmental aspects of our operations, identifying the types and harms of impacts,
- To organize training activities to raise awareness of our employees, suppliers and subcontractors on environmental protection,
- Selecting as much renewable energy resources as possible,
- In order to prevent environmental pollution, it has the duty to follow the legal, international regulations and to continuously improve the environmental performance by adapting to them.

We think it is a responsibility for leave a livable world for future generations so we are getting electricity from solar energy for our production.



Tarihçe

History

1976		Kurucumuz Erkan TEOMAN çalıştığı kurumdan ayrılarak 1976 Mart ayında nakliye hizmeti ve otobüs yedek parça alım satımına başladı.	Our founder Erkan TEOMAN left the company he was working for and started transport services and bus spare parts trading in March 1976.
1978		Kamyon taşımacılığı ile devam edildi.	Continued with truck transport.
1982		Otobüs klima sistemleri üretmeye başladı.	Started to produce bus air conditioning systems.
1988		Baturcan markasıyla motosiklet kaskı ve yedek parçası üretimine başladı.	Production of motorbike helmets and spare parts started under the Baturcan brand.
1994		Albatur A.Ş. tüzel kişiliği ile Bursa'da Şişecam bayiliği alınarak entegre ısıcam tesisi yatırımı yapıldı.	Albatur A.Ş. legal entity and Şişecam dealership in Bursa integrated insulating glass plant investment was made.
2001		Bursa Çalı'da 1600 m ² fabrika binası inşa edildi.	A 1600 m ² factory building was constructed in Bursa Çalı.
2003		Sürgü sistemlerine giriş yapıldı.	Introduction to sliding systems.
2008		Ürün montajı video çekim çalışmalarını başladı.	Product installation video shooting work has started.
2010		Bursa Çalı'da 2.000m ² 2. tesis devreye girdi.	The second facility of 2,000 m ² was put into operation in Bursa Çalı.
2011		ISO 9001 Kalite Sertifikası almaya hak kazanıldı.	ISO 9001 Quality Certificate was awarded.
2015		Canias ERP entegrasyonu hayata geçti.	Canias ERP integration has been implemented.
2016		Fabrikamıza GES ile yeşil enerji yatırımı yapıldı.	Green energy investment was made in our factory with Solar Energy System.
2017		80.000 m ² üzerinde alana 3 MW GES enerji yatırımı hayata geçti.	3 MW Solar Energy System energy investment was realised on an area of over 80.000 m ² .
2018		Firmamız TSE Kalite Belgesi almaya hak kazandı.	Our company has been awarded TSE Quality Certificate.
2020		11.000 m ² kapalı alana sahip yeni fabrikaya taşınıldı.	11.000 m ² closed area was moved to the new factory.
2022		Endüstriyel Robotik Kol yatırımlarına başlandı.	Industrial Robotic Arm investments started.

SINCE
1976

Albatur Endüstri A.Ş., 1976 yılında Bursa'da temelleri atılan köklü bir üretim şirkettir. Kuruluşundan bu yana, çeşitli endüstriyel alanlarda faaliyet göstererek kaliteli ve yenilikçi ürünler sunma misyonunu sürdürmektedir. Yıllar içinde kazandığı tecrübe ve uzmanlıkla, sektörde saygın bir konum elde etmiş ve müşteri memnuniyetini her zaman ön planda tutmuştur. Albatur Endüstri, teknolojik gelişmeleri yakından takip ederek üretim süreçlerinde sürekli iyileştirme sağlamayı hedeflemekte ve yerel pazarda olduğu kadar uluslararası arenada da büyümeye devam etmektedir.

Albatur Endüstri A.Ş. is a well-established manufacturing company founded in Bursa in 1976. Since its inception, the company has been committed to delivering high-quality and innovative products across various industrial sectors. With years of experience and expertise, Albatur Endüstri has earned a respected position in the industry, consistently prioritizing customer satisfaction. The company strives to continuously improve its production processes by closely following technological advancements and continues to grow not only in the local market but also on the international stage.



Yeni jenerasyon sürgü sistem ürünlerimizde, performans ve dayanıklılığı artırmak için yüksek kalitede rulmanlar kullanıyoruz. Rulmanlar, sürgü sistemlerinin sorunsuz ve sessiz çalışmasını sağlayan kritik bileşenlerden biridir. Kaliteli rulmanlar, sürtünmeyi minimize ederek sistemin daha uzun ömürlü olmasına ve daha az bakım gerektirmesine olanak tanır. Bu sayede, kullanıcılarımıza hem güvenli hem de yüksek performanslı bir deneyim sunuyoruz. Albatur Endüstri olarak, ürünlerimizin her aşamasında kaliteyi ön planda tutarak müşteri memnuniyetini sağlamayı ve sektörün en iyisi olmayı hedefliyoruz.

In our new generation sliding system products, we use high-quality bearings to enhance performance and durability. Bearings are critical components that ensure the smooth and quiet operation of sliding systems. High-quality bearings minimize friction, allowing the system to have a longer lifespan and require less maintenance. As a result, we provide our customers with a safe and high-performance experience. At Albatur Endüstri, we prioritize quality at every stage of our products to ensure customer satisfaction and strive to be the best in the industry.

EN 1527
100.000
CYCLES
TEST



Ürünlerimizi kalite ve dayanıklılık açısından en üst seviyede tutmak amacıyla, EN1527 standartlarına uygun olarak 100.000 çevrim testine tabi tutuyoruz. Bu testler, ürünlerimizin uzun ömürlü kullanımını ve güvenilirliğini sağlamak için titizlikle gerçekleştirilir. EN1527 standardı, kapı ve pencere donanımları için dayanıklılık, performans ve güvenlik kriterlerini belirleyen uluslararası bir standarttır. 100.000 çevrim testi, ürünlerin uzun süreli ve yoğun kullanıma dayanıklı olduğunu garanti eder. Bu sayede, müşterilerimize sunduğumuz çözümler, zorlu koşullarda dahi performanslarını koruyarak güvenle kullanılabilir. Albatur Endüstri olarak, yüksek kalite standartlarımızı koruyarak müşteri memnuniyetini her zaman ön planda tutuyoruz.

To ensure the highest levels of quality and durability, we subject our products to 100,000 cycle tests in accordance with EN1527 standards. These tests are meticulously conducted to guarantee the long-term usability and reliability of our products. The EN1527 standard is an international benchmark that defines the durability, performance, and safety criteria for door and window hardware. The 100,000 cycle test ensures that our products can withstand prolonged and intensive use. As a result, the solutions we offer to our customers maintain their performance even under challenging conditions, ensuring safe and reliable use. At Albatur Endüstri, we always prioritize customer satisfaction by upholding our high-quality standards.



Albatur Endüstri, sürgü sistemlerinin tasarımı ve üretiminde uzmanlaşmış bir mühendislik şirkettir. Şirketimizin ana ürün grubunu oluşturan sürgü sistemleri, fonksiyonellik, estetik ve dayanıklılık açısından en yüksek standartlara uygun olarak geliştirilmiştir. Yılların getirdiği tecrübe ve mühendislik birikimi ile, farklı ihtiyaçlara yönelik yenilikçi ve özelleştirilebilir çözümler sunmaktayız. Albatur Endüstri olarak, müşteri memnuniyetini en üst düzeyde tutmak için sürekli olarak ürünlerimizi geliştiriyor, modern üretim teknikleri ve yüksek kaliteli malzemeler kullanarak sürgü sistemlerinde en iyiyi hedefliyoruz.

Albatur Endüstri is an engineering company specialized in designing and manufacturing sliding systems. Sliding systems form the core of our main product group, developed to meet the highest standards of functionality, aesthetics, and durability. With years of experience and engineering expertise, we offer innovative and customizable solutions tailored to various needs. At Albatur Endüstri, we continuously improve our products to ensure the highest level of customer satisfaction, utilizing modern production techniques and high-quality materials to achieve excellence in sliding systems.

Yetkinlikler

COMPETENCES

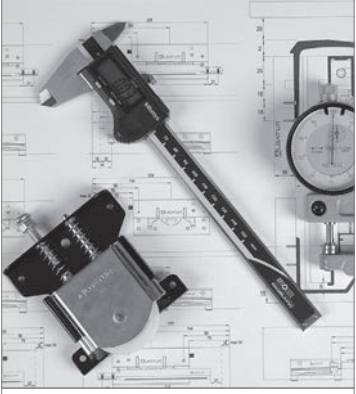

Kalite Kontrol
Quality Control



Ürün Montaj Videoları
Product Assembly Videos 3D



Ar-Ge Ürün Tasarım
R & D Product Design Process



Kalıp Tasarım ve İmalat
Mold Design Manufacturing



CNC Mekanik İşlem
CNC Machining Process



Sac Şekillendirme
Metal Sheet Forming



Robotik Otomasyon Üretim Hattı
Robotic Automation Production Line



Robotik Otomasyon Üretim Hattı
Robotic Automation Production Line

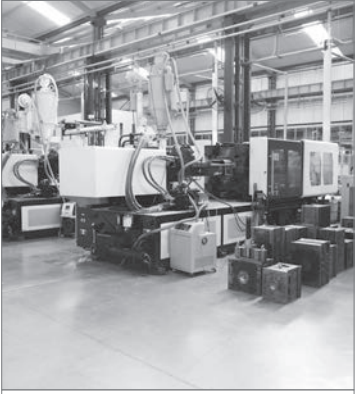

Plastik Enjeksiyon
Plastic Injection



Robotik Boya Tesisi
Robotics Paint Facility



Ürün Test Süreçleri
Products Test Process



Vibrasyon Hattı
Vibration Line



Alüminyum Profil İşleme
Aluminium Profile Processing



Geniş Ürün Stoklama
Wide Product Stocking



Montaj Prosesleri
Assembly Processes

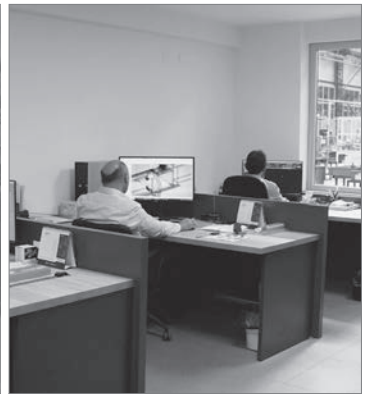

Mühendislik Süreçleri
Engineering Processes

Yetkinlikler

COMPETENCES

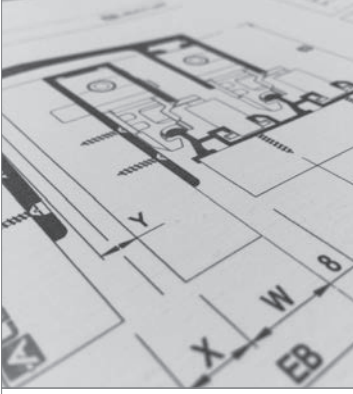

Teknik Dökümantasyon
Technical Documentation



Katalog
Catalog



Yeşil Enerji
Green Energy



Fuarlar
Exhibitions



Sertifikasyon
Certifications

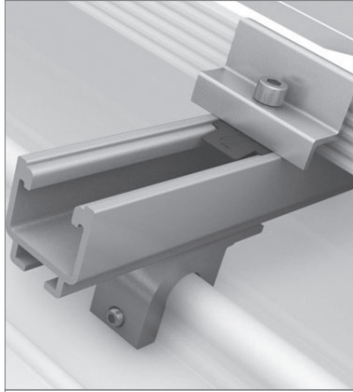

Özel Ürün Geliştirme
Special Product Development



Ürün Standları
Product Stands



Yurtiçi Satış Pazarlama
Domestic Sales Marketing



Satış Destek
Sales Support



İhracat
Export



ERP Süreç Takip Sistemi
ERP Process Control System



Ürün Tanıtım
Product Presentation



TSE Standartları
TSE Standards

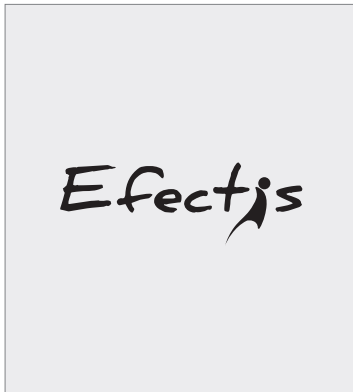

Efectis Sertifika
Efectis Certificate



B2B Portal
B2B Portal



Dijital
Digital

KALİTE POLİTİKAMIZ

Firmamızın geleceğinin ve ekonomik gelişmesinin ana garantisi müşteri tatminidir. Bu aynı zamanda personel istihdamımızın da kilit faktörüdür. Müşteri tatminini garanti etmenin esas unsurları firmamızın ve tedarikçilerimizin kaliteli olmasıdır. Tüm çalışanlarımızın hareket tarzları ve profesyonellikleri ürünlerimizin kalitesini sağlamanın esasidir. Uzun süreli başarı ekonomik gelişme ve işin devamlılığı sadece başarılı müşteri ilişkileri ile sağlanır. Personel motivasyonu firma hedefidir. Bu firma içinde ve dışında kalite uğraşı verme anlamı taşır. Her çalışan kendi profesyonelliği ve davranışı ile ürün kalitesine katkıda bulunur.

QUALITY POLICY

The main guarantee of our company's future and economical developing is customer satisfaction. This is also a key factor in the employment of staff. The main instruments to guarantee customer satisfaction is our company and suppliers of high quality. Conduct and professionalism is the cornerstone of all of our employees to ensure quality of our products. Long-term success in economic development and business continuity is achieved by only a successful customer relationship. The staff motivation is goal of the company. This has the meaning-making within and outside the profession of quality in the company. Each employee contributes to their own professionalism and behavior and product quality.

Efectis
EFFECTIS EN AVRUPA TEST VE BELGELENDİRME A.Ş.
Dışkapı OSB 5. Alan Fuar Center No:19
41040, Çiğdem (Kocaeli)
www.effectis.com

EN 1634-1 Standardı göre Yangına Dayanım Performans Beyanı

Bu belge test sonrası: **ALBATUR ENDÜSTRİ A.Ş.** tarafından Efectis EN Avrupa Test ve Belgelendirme A.Ş. tarafından yapılmıştır.

Belirtilen aksesuarlar birlikte ana kasa ve aksesuarlar alfabesi kapsamında yangına dayanım testi 23.10.2019 tarihinde: **EFFECTIS EN AVRUPA** laboratuvarında yapılmıştır. Testin ve belirlenen sonuçların detayları aşağıda belirtilmiştir.

İlgili normlar: EN 1634-1:2014+A1:2018

Test Standardı : EN 1634-1:2014+A1:2018
Test raporu numarası : 19TR19227
Sertifika raporu numarası : EEA-19-148

Test numarasında kullanılan aksesuarlar:

Aksesuar tipi, marka ve kodu : Kapı altı geçirici döşeme
Erişim noktası : Yangına dayanımlı - ALBATUR - A30 D230
Üreticinin adı ve adresi : ALBATUR ENDÜSTRİ A.Ş.
Çelik Halli No: 22. St. No:4 Çatı, NEĞİFER/BURSA/TÜRKİYE
Çatı No:101-102-103-104-105-106-107-108-109-110-111-112-113-114-115-116-117-118-119-120-121-122-123-124-125-126-127-128-129-130-131-132-133-134-135-136-137-138-139-140-141-142-143-144-145-146-147-148-149-150-151-152-153-154-155-156-157-158-159-160-161-162-163-164-165-166-167-168-169-170-171-172-173-174-175-176-177-178-179-180-181-182-183-184-185-186-187-188-189-190-191-192-193-194-195-196-197-198-199-200-201-202-203-204-205-206-207-208-209-210-211-212-213-214-215-216-217-218-219-220-221-222-223-224-225-226-227-228-229-230-231-232-233-234-235-236-237-238-239-240-241-242-243-244-245-246-247-248-249-250-251-252-253-254-255-256-257-258-259-260-261-262-263-264-265-266-267-268-269-270-271-272-273-274-275-276-277-278-279-280-281-282-283-284-285-286-287-288-289-290-291-292-293-294-295-296-297-298-299-300-301-302-303-304-305-306-307-308-309-310-311-312-313-314-315-316-317-318-319-320-321-322-323-324-325-326-327-328-329-330-331-332-333-334-335-336-337-338-339-340-341-342-343-344-345-346-347-348-349-350-351-352-353-354-355-356-357-358-359-360-361-362-363-364-365-366-367-368-369-370-371-372-373-374-375-376-377-378-379-380-381-382-383-384-385-386-387-388-389-390-391-392-393-394-395-396-397-398-399-400-401-402-403-404-405-406-407-408-409-410-411-412-413-414-415-416-417-418-419-420-421-422-423-424-425-426-427-428-429-430-431-432-433-434-435-436-437-438-439-440-441-442-443-444-445-446-447-448-449-450-451-452-453-454-455-456-457-458-459-460-461-462-463-464-465-466-467-468-469-470-471-472-473-474-475-476-477-478-479-480-481-482-483-484-485-486-487-488-489-490-491-492-493-494-495-496-497-498-499-500-501-502-503-504-505-506-507-508-509-510-511-512-513-514-515-516-517-518-519-520-521-522-523-524-525-526-527-528-529-530-531-532-533-534-535-536-537-538-539-540-541-542-543-544-545-546-547-548-549-550-551-552-553-554-555-556-557-558-559-560-561-562-563-564-565-566-567-568-569-570-571-572-573-574-575-576-577-578-579-580-581-582-583-584-585-586-587-588-589-590-591-592-593-594-595-596-597-598-599-600-601-602-603-604-605-606-607-608-609-610-611-612-613-614-615-616-617-618-619-620-621-622-623-624-625-626-627-628-629-630-631-632-633-634-635-636-637-638-639-640-641-642-643-644-645-646-647-648-649-650-651-652-653-654-655-656-657-658-659-660-661-662-663-664-665-666-667-668-669-670-671-672-673-674-675-676-677-678-679-680-681-682-683-684-685-686-687-688-689-690-691-692-693-694-695-696-697-698-699-700-701-702-703-704-705-706-707-708-709-710-711-712-713-714-715-716-717-718-719-720-721-722-723-724-725-726-727-728-729-730-731-732-733-734-735-736-737-738-739-740-741-742-743-744-745-746-747-748-749-750-751-752-753-754-755-756-757-758-759-760-761-762-763-764-765-766-767-768-769-770-771-772-773-774-775-776-777-778-779-780-781-782-783-784-785-786-787-788-789-790-791-792-793-794-795-796-797-798-799-800-801-802-803-804-805-806-807-808-809-810-811-812-813-814-815-816-817-818-819-820-821-822-823-824-825-826-827-828-829-830-831-832-833-834-835-836-837-838-839-840-841-842-843-844-845-846-847-848-849-850-851-852-853-854-855-856-857-858-859-860-861-862-863-864-865-866-867-868-869-870-871-872-873-874-875-876-877-878-879-880-881-882-883-884-885-886-887-888-889-890-891-892-893-894-895-896-897-898-899-900-901-902-903-904-905-906-907-908-909-910-911-912-913-914-915-916-917-918-919-920-921-922-923-924-925-926-927-928-929-930-931-932-933-934-935-936-937-938-939-940-941-942-943-944-945-946-947-948-949-950-951-952-953-954-955-956-957-958-959-960-961-962-963-964-965-966-967-968-969-970-971-972-973-974-975-976-977-978-979-980-981-982-983-984-985-986-987-988-989-990-991-992-993-994-995-996-997-998-999-1000-1001-1002-1003-1004-1005-1006-1007-1008-1009-1010-1011-1012-1013-1014-1015-1016-1017-1018-1019-1020-1021-1022-1023-1024-1025-1026-1027-1028-1029-1030-1031-1032-1033-1034-1035-1036-1037-1038-1039-1040-1041-1042-1043-1044-1045-1046-1047-1048-1049-1050-1051-1052-1053-1054-1055-1056-1057-1058-1059-1060-1061-1062-1063-1064-1065-1066-1067-1068-1069-1070-1071-1072-1073-1074-1075-1076-1077-1078-1079-1080-1081-1082-1083-1084-1085-1086-1087-1088-1089-1090-1091-1092-1093-1094-1095-1096-1097-1098-1099-1100-1101-1102-1103-1104-1105-1106-1107-1108-1109-1110-1111-1112-1113-1114-1115-1116-1117-1118-1119-1120-1121-1122-1123-1124-1125-1126-1127-1128-1129-1130-1131-1132-1133-1134-1135-1136-1137-1138-1139-1140-1141-1142-1143-1144-1145-1146-1147-1148-1149-1150-1151-1152-1153-1154-1155-1156-1157-1158-1159-1160-1161-1162-1163-1164-1165-1166-1167-1168-1169-1170-1171-1172-1173-1174-1175-1176-1177-1178-1179-1180-1181-1182-1183-1184-1185-1186-1187-1188-1189-1190-1191-1192-1193-1194-1195-1196-1197-1198-1199-1200-1201-1202-1203-1204-1205-1206-1207-1208-1209-1210-1211-1212-1213-1214-1215-1216-1217-1218-1219-1220-1221-1222-1223-1224-1225-1226-1227-1228-1229-1230-1231-1232-1233-1234-1235-1236-1237-1238-1239-1240-1241-1242-1243-1244-1245-1246-1247-1248-1249-1250-1251-1252-1253-1254-1255-1256-1257-1258-1259-1260-1261-1262-1263-1264-1265-1266-1267-1268-1269-1270-1271-1272-1273-1274-1275-1276-1277-1278-1279-1280-1281-1282-1283-1284-1285-1286-1287-1288-1289-1290-1291-1292-1293-1294-1295-1296-1297-1298-1299-1300-1301-1302-1303-1304-1305-1306-1307-1308-1309-1310-1311-1312-1313-1314-1315-1316-1317-1318-1319-1320-1321-1322-1323-1324-1325-1326-1327-1328-1329-1330-1331-1332-1333-1334-1335-1336-1337-1338-1339-1340-1341-1342-1343-1344-1345-1346-1347-1348-1349-1350-1351-1352-1353-1354-1355-1356-1357-1358-1359-1360-1361-1362-1363-1364-1365-1366-1367-1368-1369-1370-1371-1372-1373-1374-1375-1376-1377-1378-1379-1380-1381-1382-1383-1384-1385-1386-1387-1388-1389-1390-1391-1392-1393-1394-1395-1396-1397-1398-1399-1400-1401-1402-1403-1404-1405-1406-1407-1408-1409-1410-1411-1412-1413-1414-1415-1416-1417-1418-1419-1420-1421-1422-1423-1424-1425-1426-1427-1428-1429-1430-1431-1432-1433-1434-1435-1436-1437-1438-1439-1440-1441-1442-1443-1444-1445-1446-1447-1448-1449-1450-1451-1452-1453-1454-1455-1456-1457-1458-1459-1460-1461-1462-1463-1464-1465-1466-1467-1468-1469-1470-1471-1472-1473-1474-1475-1476-1477-1478-1479-1480-1481-1482-1483-1484-1485-1486-1487-1488-1489-1490-1491-1492-1493-1494-1495-1496-1497-1498-1499-1500-1501-1502-1503-1504-1505-1506-1507-1508-1509-1510-1511-1512-1513-1514-1515-1516-1517-1518-1519-1520-1521-1522-1523-1524-1525-1526-1527-1528-1529-1530-1531-1532-1533-1534-1535-1536-1537-1538-1539-1540-1541-1542-1543-1544-1545-1546-1547-1548-1549-1550-1551-1552-1553-1554-1555-1556-1557-1558-1559-1560-1561-1562-1563-1564-1565-1566-1567-1568-1569-1570-1571-1572-1573-1574-1575-1576-1577-1578-1579-1580-1581-1582-1583-1584-1585-1586-1587-1588-1589-1590-1591-1592-1593-1594-1595-1596-1597-1598-1599-1600-1601-1602-1603-1604-1605-1606-1607-1608-1609-1610-1611-1612-1613-1614-1615-1616-1617-1618-1619-1620-1621-1622-1623-1624-1625-1626-1627-1628-1629-1630-1631-1632-1633-1634-1635-1636-1637-1638-1639-1640-1641-1642-1643-1644-1645-1646-1647-1648-1649-1650-1651-1652-1653-1654-1655-1656-1657-1658-1659-1660-1661-1662-1663-1664-1665-1666-1667-1668-1669-1670-1671-1672-1673-1674-1675-1676-1677-1678-1679-1680-1681-1682-1683-1684-1685-1686-1687-1688-1689-1690-1691-1692-1693-1694-1695-1696-1697-1698-1699-1700-1701-1702-1703-1704-1705-1706-1707-1708-1709-1710-1711-1712-1713-1714-1715-1716-1717-1718-1719-1720-1721-1722-1723-1724-1725-1726-1727-1728-1729-1730-1731-1732-1733-1734-1735-1736-1737-1738-1739-1740-1741-1742-1743-1744-1745-1746-1747-1748-1749-1750-1751-1752-1753-1754-1755-1756-1757-1758-1759-1760-1761-1762-1763-1764-1765-1766-1767-1768-1769-1770-1771-1772-1773-1774-1775-1776-1777-1778-1779-1780-1781-1782-1783-1784-1785-1786-1787-1788-1789-1790-1791-1792-1793-1794-1795-1796-1797-1798-1799-1800-1801-1802-1803-1804-1805-1806-1807-1808-1809-1810-1811-1812-1813-1814-1815-1816-1817-1818-1819-1820-1821-1822-1823-1824-1825-1826-1827-1828-1829-1830-1831-1832-1833-1834-1835-1836-1837-1838-1839-1840-1841-1842-1843-1844-1845-1846-1847-1848-1849-1850-1851-1852-1853-1854-1855-1856-1857-1858-1859-1860-1861-1862-1863-1864-1865-1866-1867-1868-1869-1870-1871-1872-1873-1874-1875-1876-1877-1878-1879-1880-1881-1882-1883-1884-1885-1886-1887-1888-1889-1890-1891-1892-1893-1894-1895-1896-1897-1898-1899-1900-1901-1902-1903-1904-1905-1906-1907-1908-1909-1910-1911-1912-1913-1914-1915-1916-1917-1918-1919-1920-1921-1922-1923-1924-1925-1926-1927-1928-1929-1930-1931-1932-1933-1934-1935-1936-1937-1938-1939-1940-1941-1942-1943-1944-1945-1946-1947-1948-1949-1950-1951-1952-1953-1954-1955-1956-1957-1958-1959-1960-1961-1962-1963-1964-1965-1966-1967-1968-1969-1970-1971-1972-1973-1974-1975-1976-1977-1978-1979-1980-1981-1982-1983-1984-1985-1986-1987-1988-1989-1990-1991-1992-1993-1994-1995-1996-1997-1998-1999-2000-2001-2002-2003-2004-2005-2006-2007-2008-2009-2010-2011-2012-2013-2014-2015-2016-2017-2018-2019-2020-2021-2022-2023-2024-2025-2026-2027-2028-2029-2030-2031-2032-2033-2034-2035-2036-2037-2038-2039-2040-2041-2042-2043-2044-2045-2046-2047-2048-2049-2050-2051-2052-2053-2054-2055-2056-2057-2058-2059-2060-2061-2062-2063-2064-2065-2066-2067-2068-2069-2070-2071-2072-2073-2074-2075-2076-2077-2078-2079-2080-2081-2082-2083-2084-2085-2086-2087-2088-2089-2090-2091-2092-2093-2094-2095-2096-2097-2098-2099-2100-2101-2102-2103-2104-2105-2106-2107-2108-2109-2110-2111-2112-2113-2114-2115-2116-2117-2118-2119-2120-2121-2122-2123-2124-2125-2126-2127-2128-2129-2130-2131-2132-2133-2134-2135-2136-2137-2138-2139-2140-2141-2142-2143-2144-2145-2146-2147-2148-2149-2150-2151-2152-2153-2154-2155-2156-2157-2158-2159-2160-2161-2162-2163-2164-2165-2166-2167-2168-2169-2170-2171-2172-2173-2174-2175-2176-2177-2178-2179-2180-2181-2182-2183-2184-2185-2186-2187-2188-2189-2190-2191-2192-2193-2194-2195-2196-2197-2198-2199-2200-2201-2202-2203-2204-2205-2206-2207-2208-2209-2210-2211-2212-2213-2214-2215-2216-2217-2218-2219-2220-2221-2222-2223-2224-2225-2226-2227-2228-2229-2230-2231-2232-2233-2234-2235-2236-2237-2238-2239-2240-2241-2242-2243-2244-2245-2246-2247-2248-2249-2250-2251-2252-2253-2254-2255-2256-2257-2258-2259-2260-2261-2262-2263-2264-2265-2266-2267-2268-2269-2270-2271-2272-2273-2274-2275-2276-2277-2278-2279-2280-2281-2282-2283-2284-2285-2286-2287-2288-2289-2290-2291-2292-2293-2294-2295-2296-2297-2298-2299-2300-2301-2302-2303-2304-2305-2306-2307-2308-2309-2310-2311-2312-2313-2314-2315-2316-2317-2318-2319-2320-2321-2322-2323-2324-2325-2326-2327-2328-2329-2330-2331-2332-2333-2334-2335-2336-2337-2338-2339-2340-2341-2342-2343-2344-2345-2346-2347-2348-2349-2350-2351-2352-2353-2354-2355-2356-2357-2358-2359-2360-2361-2362-2363-2364-2365-2366-2367-2368-2369-2370-2371-2372-2373-2374-2375-2376-2377-2378-2379-2380-2381-2382-2383-2384-2385-2386-2387-2388-2389-2390-2391-2392-2393-2394-2395-2396-2397-2398-2399-2400-2401-2402-2403-2404-2405-2406-2407-2408-2409-2410-2411-2412-2413-2414-2415-2416-2417-2418-2419-2420-2421-2422-2423-2424-2425-2426-2427-2428-2429-2430-2431-2432-2433-2434-2435-2436-2437-2438-2439-2440-2441-2442-2443-2444-2445-2446-2447-2448-2449-2450-2451-2452-2453-2454-2455-2456-2457-2458-2459-2460-2461-2462-2463-2464-2465-2466-2467-2468-2469-2470-2471-2472-2473-2474-2475-2476-2477-2478-2479-2480-2481-2482-2483-2484-2485-2486-2487-2488-2489-2490-2491-2492-2493-2494-2495-2496-2497-2498-2499-2500-2501-2502-2503-2504-2505-2506-2507-2508-2509-2510-2511-2512-2513-2514-2515-2516-2517-2518-2519-2520-2521-2522-2523-2524-2525-2526-2527-2528-2529-2530-2531-2532-2533-2534-2535-2536-2537-2538-2539-2540-2541-2542-2543-2544-2545-2546-2547-2548-2549-2550-2551-2552-2553-2

Belgelerimiz ve Kalite Politikamız

CERTIFICATIONS AND QUALITY POLICY

SÜREKLİ GELİŞİM

Yüksek seviyede müşteri tatminini, rekabet gücünü sağlamak ve proses kalitesini muhafaza etmek için uğraşmak bizce yeterli değildir. Hedefimiz kaliteyi devamlı geliştirmektir. En iyileri ile yarışarak en iyi olmak için çaba sarf ederiz. Biz diğer kişilerinde işlerinin önemli olduğu bilinci ile omuz omuza çalışırız.

Hepimiz kendi sahamızdaki uygulamalarda uzmanız. Ortak hedefleri başarmak için azami kişisel katılımları sağlama yolunda ekipler halinde çalışırız. Firmamızın başarısında katkıda buldukları için tedarikçilerimizi ortaklarımız olarak görürüz. Bağlantılı olarak firmamızı geliştirme ekibine aktif olarak katılmalarından emin olmak için en iyilerini seçeriz. Kalitemizi müşteri beklentilerine göre ölçeriz.

CONTINUOUS IMPROVEMENT

To ensure a high level of customer satisfaction and competitiveness is not enough to deal with in order to maintain the quality of the process. Our goal is to improve quality continuously. Strive to be the best in competing with the best. We work shoulder to shoulder with the understanding that other persons too have important jobs. We are all experts in their own department applications. In order to achieve common goals as a team work towards ensuring maximum personal participation.

We see our suppliers as partners for contributing to the success of our company. In connection with the development team in our company we choose the best ones to make sure that the active participation. Quality measure based on customer expectations.

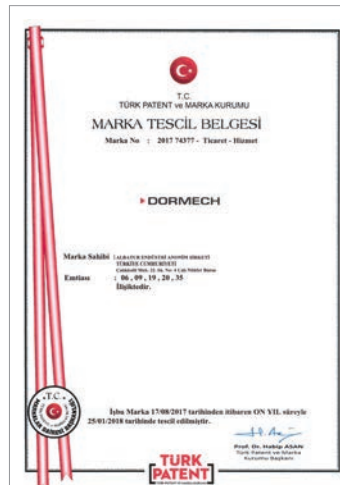

Kod Sistemi

CODE SYSTEM

Sipariş Kodu
Order Code

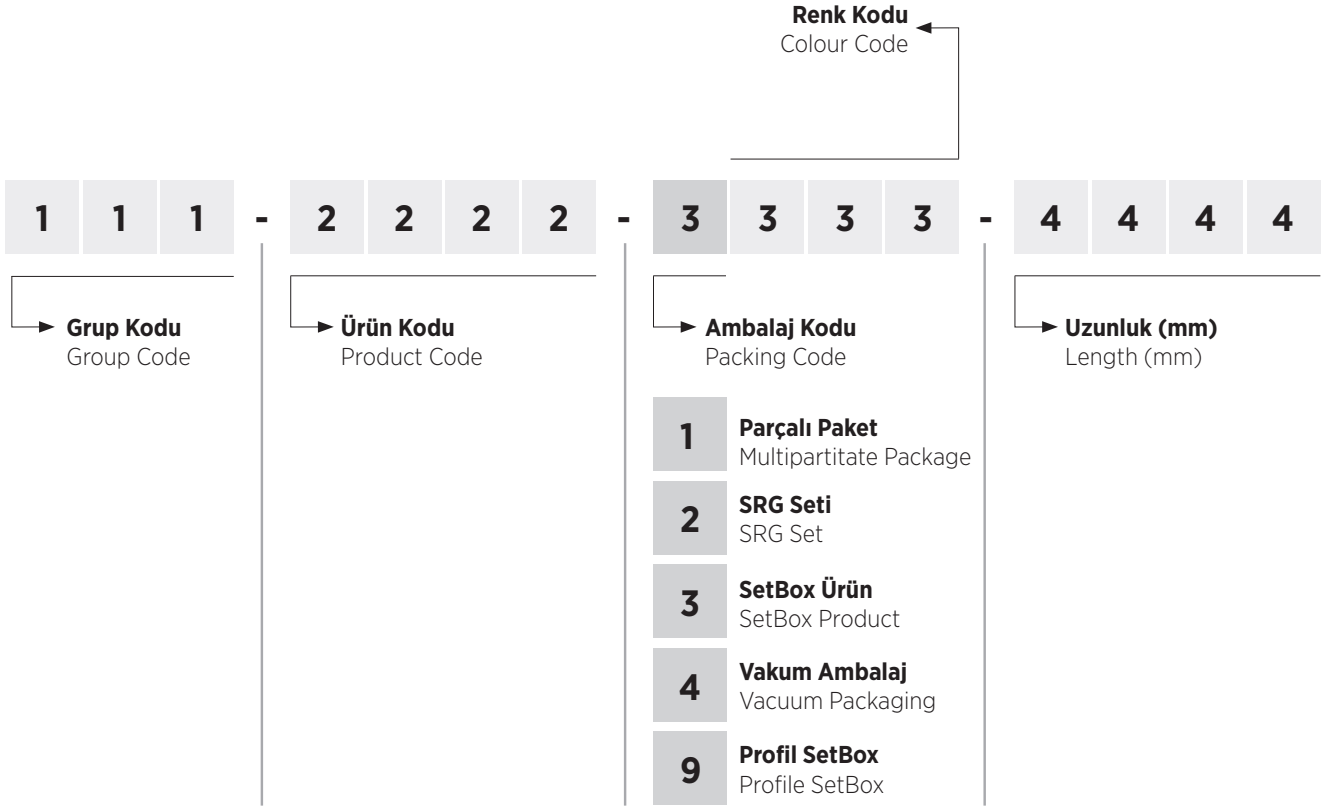

Sipariş Kodu
Order Code

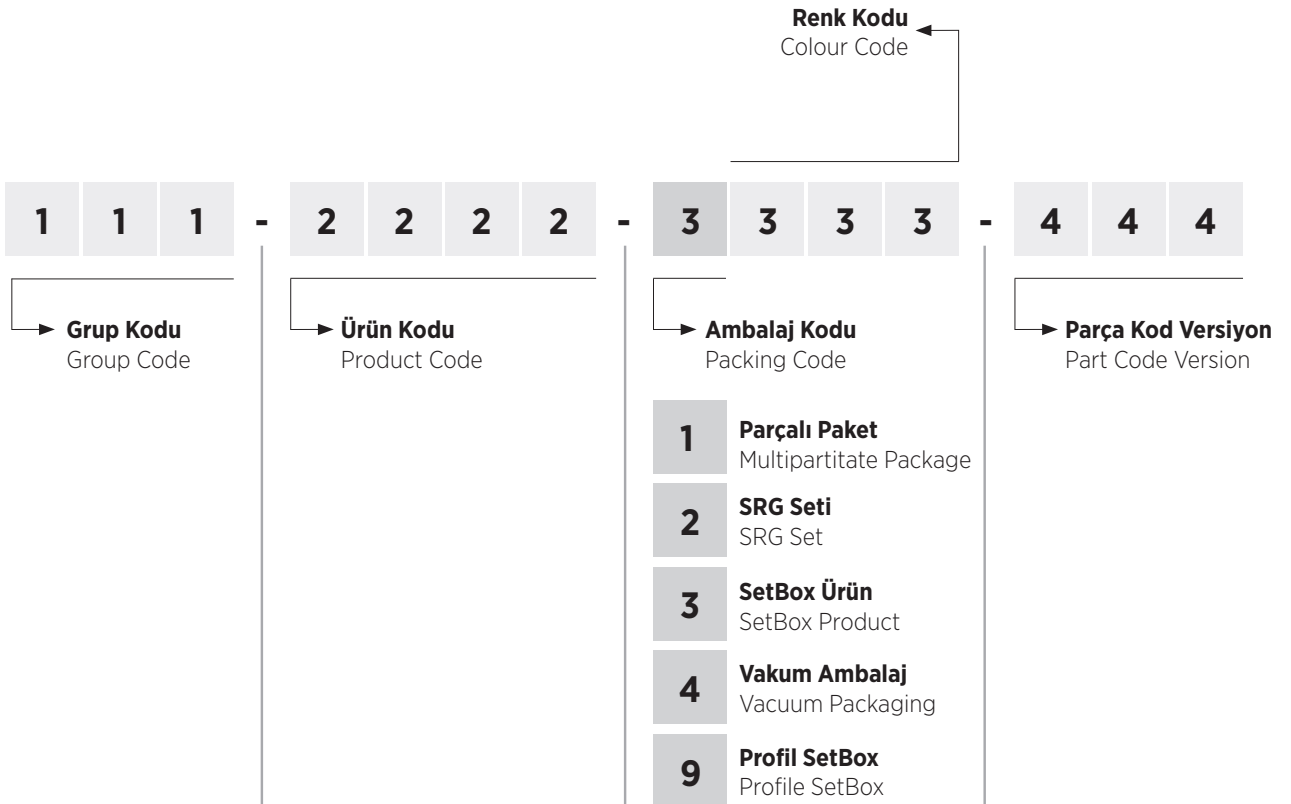

Semboller

SYMBOLS

1  Dolap Sistemi Wardrobe System	2  Kapı Sistemi Door System	3  Teleskopik Kapı Sistemi Telescopic Door System	4  Klasik Kapı Sistemi Classic Door System	5  Çekmece Sistemi Drawer System	6  İçten Sistem Internal System	7  Dıştan Sistem External System
8  Karma Alt Taşıyıcı Combined Bottom Carrier	9  Karma Üst Taşıyıcı Combined Top Carrier	10  Dıştan Tek Kanat External Single Door	11  Üst Taşıyıcı Top Carrier	12  L Kanat L Wing	13  Katlanır Kapak Foldable Cabinet Door	14  Sürme Kapı Sliding Door
15  Sürme Kapı Sliding Door	16  Senkronize Kapı Funicular Door	17  Katlanır Kapı Foldable Door	18  Katlanır Kapı Pivot Foldable Door Pivot	19  Ahşap Wooden	20  Cam Glass	21  Ahşap - Cam Wooden - Glass
22  Ahşap - Metal Wooden - Metal	23  Stoper With Stopper	24  Tek Yöne Yavaşlatıcı Uygulanabilir Apply to one Way Soft Closing	25  Çift Yöne Yavaşlatıcı Uygulanabilir Apply to two Way Soft Closing	26  Panel Kalınlık Panel Thickness	27  Ağırık Weight	28  Yükseklik Ayarlı Height Adjustable
29  Yatay Ayarlı Horizontal Adjustable	30  Dönüş Açısı Rotation Angle	31  Rüzgar Yalıtım Wind Insulation	32  Hava Geçer Air Pass Through	33  Ses Yalıtımı Sound Proof	34  Toz Yalıtımı Dust Insulation	35  Işık Yalıtımı Özelliği Light Isolation Feature
36  Yangın Dayanımlı Fire Resistance	37  Duman Yalıtımı Smoke Proof	38  Enerji Yalıtımı Özelliği Energy Isolation Feature	39  Bozuk Yüzeylerde Uygulanabilir Can Be Applied to Faulty Surface	40  Engelli Bireyler İçin Uygundur Suitable For Disabled People	41  Haşereleri Engeller Pests Prevent	42  Video Video
43  Yağlı Piston Sistemi Oil Damper System	44  Havalı Piston Sistemi Air Damper System	45  Kutu İçİ Montaj Şeması Prospectus	46  Elektrikli Electrical	47  Set Ambalaj Set Packing	48  Ürün Palet Miktarı Product Pallet Quantity	49  Poşet Ambalaj Bag Packaging
50  Kutu İçİ Miktar In-Box Quantity	51  Koli İçİ Miktar In-Package Quantity	52  Cam Delik Delme Glass Hole Drilling	53  Alt Kılavuz Bottom Guide	54  Cam Sıkıştırma Glass Compression	55  90 Derece Katlanır Kapı 90 Degree Bi-Folding Door	56  180 Derece Katlanır Kapı 180 Degree Bi-Folding Door
57  Katlanır Kapı 2 Kanat Foldable Door 2 Door	58  Katlanır Kapı 4 Kanat Foldable Door 4 Door	59	60	61	62	63

Ürün Grupları

PRODUCT GROUPS

Coplanar®		Hemyüz Sürme Gardırop Serisi Coplanar Sliding Wardrobe Series	Page 30 Group 101
TopSlide®		Sürme Gardırop Serileri Sliding Wardrobe Series	Page 32 Group 102
Multiline®		Sürme Kapak Serisi Sliding Door Series	Page 54 Group 103
WingSlide®		Sürme Katlanır Kapak Serisi Sliding Foldable Door Series	Page 112 Group 105
Glassline®		Sürme Cam Kapak Serisi Sliding Glass Door Series	Page 124 Group 108
Rigel®		Sürme Ray Dolap Serisi Sliding Rail Wardrobe Series	Page 132 Group 109
TvSlide®		Sürme Tv Ünite Serisi Sliding Tv Unit Series	Page 142 Group 110
Softline®		Yavaşlatıcı Serisi Soft Closers Series	Page 144 Group 117
Pulltens®		Çek-Ger Serisi Pull & Tension Series	Page 160 Group 118
BarnDoor®		BarnDoor Sürme Kapı Serisi BarnDoor Sliding Door Series	Page 168 Group 119
DoorSlide®		Ahşap Sürme Kapı Serisi Wooden Sliding Door Series	Page 182 Group 120
DoorSync®Wood		Ahşap Senkronize Sürme Kapı Serisi Wooden Funicular Sliding Door Series	Page 214 Group 121
MasterFold® MidFold®		Ahşap Katlanır Sürme Kapı Serisi Wooden Foldable Sliding Door Series	Page 228 Group 122

Ürün Grupları

PRODUCT GROUPS

GlassDoor®		Cam Sürme Kapı Serisi Glass Door Sliding Series	Page 246 Group 123
DoorSync®Glass		Cam Senkronize Sürme Kapı Serisi Funicular Glass Door Series	Page 264 Group 124
MultiDoor®		Teleskopik Ahşap Sürme Kapı Serisi Telescopic Wooden Sliding Door Series	Page 274 Group 127
Underline®		Kapı Altı Giyotin Serisi Door Seal Series	Page 288 Group 130
Door Hardware Kapı Donanımları		Kapı Donanımları Serisi Door Hardware Series	Page 298 Group 131
MagicLift®		Gardırop Donanımları Serisi Wardrobe Equipments Series	Page 304 Group 135
Ventil®Aluminium		Alüminyum Dekoratif Menfez Serisi Aluminium Air Ventilation Cover Series	Page 312 Group 140
Ventil®Plastic		Plastik Dekoratif Menfez Serisi Plastic Air Ventilation Cover Series	Page 320 Group 141
TurnTable®		Döner Tabla Mekanizma Serisi Swivel Plate - Turnable Table Series	Page 330 Group 142
Master+		Mobilya Aksesuar Serisi Furniture Accessories Series	Page 340 Group 143
Feet		Koltuk ve Baza Ayakları Serisi Furniture Feet Series	Page 348 Group 144
Aluminium		Alüminyum Profil Serisi Aluminium Profile Series	Page 354 Group 150
HingeTech		Menteşe Serisi Hinge Series	Page 356 Group 160

101 Coplanar®

Hemyüz Sürme Gardirop Serisi • Coplanar Sliding Wardrobe Series

Coplanar 8888	101-8888	40 Kg Ayarlı Gardirop Hemyüz Sürme Kapak Sistemi 18-40 mm31
		40 Kg Adjustable Coplanar Sliding Wardrobe System

102 TopSlide®

Sürme Gardirop Serisi • Sliding Wardrobe Series

TopSlide 8220	102- 8220	100 Kg Ayarlı Sürme Gardirop Sistemi • 100 Kg Adjustable Sliding Wardrobe System 16-20 mm36
TopSlide 8232	102-8232	100 Kg Ayarlı Sürme Gardirop Sistemi • 100 Kg Adjustable Sliding Wardrobe System 18-30 mm37
TopSlide 8235	102-8235	100 Kg Ayarlı Sürme Gardirop Sistemi • 100 Kg Adjustable Sliding Wardrobe System 18-35 mm38
TopSlide 8240	102-8240	100 Kg Ayarlı Sürme Gardirop Sistemi • 100 Kg Adjustable Sliding Wardrobe System 18-40 mm39
TopSlide 8250	102-8250	100 Kg Ayarlı Sürme Gardirop Sistemi • 100 Kg Adjustable Sliding Wardrobe System 18-50 mm40
TopSlide 8223	102-8223	100 Kg Ayarlı Sürme Gardirop Sistemi • 100 Kg Adjustable Sliding Wardrobe System 16-20 mm41
TopSlide 8233	102-8233	100 Kg Ayarlı Sürme Gardirop Sistemi • 100 Kg Adjustable Sliding Wardrobe System 18-30 mm42
TopSlide 8320	102-8320	100 Kg Ayarlı Sürme Gardirop Sistemi • 100 Kg Adjustable Sliding Wardrobe System 16-18 mm43
TopSlide 8080	102-8080	100 Kg Ayarlı Sürme Gardirop Sistemi • 100 Kg Adjustable Sliding Wardrobe System 18-28 mm44
TopSlide 8040	102-8040	70 Kg Ayarlı Sürme Gardirop Sistemi • 70 Kg Adjustable Sliding Wardrobe System 18 mm45
TopSlide 8010	102-8010	60 Kg Ayarlı Sürme Gardirop Sistemi • 60 Kg Adjustable Sliding Wardrobe System 18 mm46
TopSlide 7320	102- 7320	60 Kg Ayarlı Sürme Gardirop Sistemi • 60 Kg Adjustable Sliding Wardrobe System 16-22 mm47
TopSlide 8030	102-8030	60 Kg Ayarlı Sürme Gardirop Sistemi • 60 Kg Adjustable Sliding Wardrobe System 16-25 mm48
TopSlide 8400	102-8400	60 Kg Ayarlı Sürme Gardirop Sistemi • 60 Kg Adjustable Sliding Wardrobe System 16-25 mm49
TopSlide 0190	102-0190	70 Kg Ayarlı Sürme Gardirop Sistemi • 70 Kg Adjustable Sliding Wardrobe System 16-50 mm50
TopSlide 0195	102-0195	50 Kg Ayarlı Sürme Gardirop Sistemi • 50 Kg Adjustable Sliding Wardrobe System 16-50 mm51
TopSlide 0200	102-0200	50 Kg Ayarlı Sürme Gardirop Sistemi • 50 Kg Adjustable Sliding Wardrobe System 16-50 mm52

103 Multiline®

Sürme Kapak Serisi • Sliding Door Series

Multiline 1	103-1010	50 Kg Ayarlı Sürme Kapak Sistemi • 50 Kg Adjustable Sliding Door System 16-22 mm60
Multiline 2	103-1020	50 Kg Ayarlı Sürme Kapak Sistemi • 50 Kg Adjustable Sliding Door System 16-22 mm61
Multiline 3	103-1030	40 Kg Ayarlı Sürme Kapak Sistemi • 40 Kg Adjustable Sliding Door System 16-22 mm62
Multiline 4	103-1040	50 Kg Ayarlı Sürme Kapak Sistemi • 50 Kg Adjustable Sliding Door System 16-30 mm63
Multiline 5	103-1050	20 Kg Ayarlı Sürme Kapak Sistemi • 20 Kg Adjustable Sliding Door System 18-25 mm64
Multiline 7	103-1070	50 Kg Ayarlı Sürme Kapak Sistemi • 50 Kg Adjustable Sliding Door System 18-30 mm65
Multiline 8	103-1080	50 Kg Ayarlı Sürme Kapak Sistemi • 50 Kg Adjustable Sliding Door System 16-30 mm66
Multiline 9	103-1090	45 Kg Ayarlı Sürme Kapak Sistemi • 45 Kg Adjustable Sliding Door System 18-30 mm67
Multiline 10	103-1100	50 Kg Ayarlı Sürme Kapak Sistemi • 50 Kg Adjustable Sliding Door System 16-22 mm68
Multiline 11	103-1110	50 Kg Ayarlı Sürme Kapak Sistemi • 50 Kg Adjustable Sliding Door System 16-22 mm69
Multiline 12	103-1120	50 Kg Ayarlı Sürme Kapak Sistemi • 50 Kg Adjustable Sliding Door System 16-22 mm70
Multiline 13	103-1130	50 Kg Ayarlı Sürme Kapak Sistemi • 50 Kg Adjustable Sliding Door System 16-22 mm71
Multiline 14	103-1140	15 Kg Ayarlı Sürme Kapak Sistemi • 15 Kg Adjustable Sliding Door System 16-30 mm72
Multiline 15	103-1150	50 Kg Ayarlı Sürme Kapak Sistemi • 50 Kg Adjustable Sliding Door System 18-22 mm74
Multiline 16	103-1160	50 Kg Ayarlı Sürme Kapak Sistemi • 50 Kg Adjustable Sliding Door System 16-22 mm75
Multiline 17	103-1170	50 Kg Ayarlı Sürme Kapak Sistemi • 50 Kg Adjustable Sliding Door System 16-22 mm76
Multiline 18	103-1180	50 Kg Ayarlı Sürme Kapak Sistemi • 50 Kg Adjustable Sliding Door System 18-30 mm77
Multiline SRG 100	103-0100	60 Kg Ayarlı Sürme Kapak Sistemi • 60 Kg Adjustable Sliding Door System 18-22 mm78
Multiline SRG 300	103-0300	70 Kg Ayarlı Sürme Kapak Sistemi • 70 Kg Adjustable Sliding Door System 18-22 mm79
Multiline SRG 110	103-0110	70 Kg Ayarlı Sürme Kapak Sistemi • 70 Kg Adjustable Sliding Door System 18-20 mm80
Multiline SRG 115	103-0115	70 Kg Ayarlı Sürme Kapak Sistemi • 70 Kg Adjustable Sliding Door System 18-20 mm81
Multiline SRG 210	103-0210	80 Kg Ayarlı Sürme Kapak Sistemi • 80 Kg Adjustable Sliding Door System 18-22 mm82
Multiline SRG 120	103-0120	80 Kg Ayarlı Sürme Kapak Sistemi • 80 Kg Adjustable Sliding Door System 18-22 mm84
Multiline SRG 125	103-0125	70 Kg Ayarlı Sürme Kapak Sistemi • 70 Kg Adjustable Sliding Door System 18-22 mm85
Multiline SRG 130	103-0130	60 Kg Ayarlı Sürme Kapak Sistemi • 60 Kg Adjustable Sliding Door System 18-22 mm86
Multiline SRG 135	103-0135	60 Kg Ayarlı Sürme Kapak Sistemi • 60 Kg Adjustable Sliding Door System 18-22 mm87
Multiline SRG 140	103-0140	60 Kg Ayarlı Sürme Kapak Sistemi • 60 Kg Adjustable Sliding Door System 18-22 mm88
Multiline SRG 145	103-0145	60 Kg Ayarlı Sürme Kapak Sistemi • 60 Kg Adjustable Sliding Door System 18-22 mm89

Multiline 7036	103-7036	70 Kg Ayarlı Sürme Kapak Sistemi • 70 Kg Adjustable Sliding Door System 18-20 mm 90
Multiline 7038	103-7038	70 Kg Ayarlı Sürme Kapak Sistemi • 70 Kg Adjustable Sliding Door System 18-20 mm 91
Multiline 7030	103-7030	75 Kg Ayarlı Sürme Kapak Sistemi • 75 Kg Adjustable Sliding Door System 18-22 mm 92
Multiline 7031	103-7031	75 Kg Ayarlı Sürme Kapak Sistemi • 75 Kg Adjustable Sliding Door System 18-30 mm 93
Multiline 7032	103-7032	75 Kg Ayarlı Sürme Kapak Sistemi • 75 Kg Adjustable Sliding Door System 18-22 mm 94
Multiline 7012	103-7012	80 Kg Ayarlı Sürme Kapak Sistemi • 80 Kg Adjustable Sliding Door System 18-22 mm 95
Multiline 7010	103-7010	80 Kg Ayarlı Sürme Kapak Sistemi • 80 Kg Adjustable Sliding Door System 18-22 mm 96
Multiline 7011	103-7011	70 Kg Ayarlı Sürme Kapak Sistemi • 70 Kg Adjustable Sliding Door System 18-22 mm 97
Multiline 7020	103-7020	70 Kg Ayarlı Sürme Kapak Sistemi • 70 Kg Adjustable Sliding Door System 18-22 mm 98
Multiline 7060	103-7060	60 Kg Ayarlı Sürme Kapak Sistemi • 60 Kg Adjustable Sliding Door System 18-30 mm 99
Multiline 7055	103-7055	60 Kg Ayarlı Sürme Kapak Sistemi • 60 Kg Adjustable Sliding Door System 18-30 mm 100
Multiline 6400	103-6400	45 Kg Ayarlı Sürme Kapak Sistemi • 45 Kg Adjustable Sliding Door System 18-30 mm 101
Multiline 7040	103-7040	40 Kg Hafif Sürme Kapak Sistemi • 40 Kg Light Sliding Door System 18-30 mm 102
Multiline 7045	103-7045	45 Kg Hafif Sürme Kapak Sistemi • 45 Kg Light Sliding Door System 18-30 mm 103
Multiline 6500	103-6500	15 Kg Ayarlı Hafif Sürme Kapak Sistemi • 15 Kg Adjustable Light Sliding Door System 18 mm 104
Multiline 6510	103-6510	15 Kg Ayarlı Hafif Sürme Kapak Sistemi • 15 Kg Adjustable Light Sliding Door System 18 mm 105
Multiline 6000	103-6000	40 Kg Ayarlı Sürme Kapak Sistemi • 40 Kg Adjustable Sliding Door System 18 mm 106
Multiline 0171	103-0171	30 Kg Ayarlı Sürme Kapak Sistemi • 30 Kg Adjustable Sliding Door System 18 mm 107
Multiline 6600	103-6600	25 Kg Ayarlı Sürme Kapak Sistemi • 25 Kg Adjustable Sliding Door System 18 mm 108
Multiline 6320	103-6320	19 Kg Ayarlı Sürme Kapak Sistemi • 19 Kg Adjustable Sliding Door System 18 mm 109
Multiline 6100	103-6100	30 Kg Sürme Kapak Sistemi • 30 Kg Sliding Door System 18 mm 110
Multiline 7601	103-7601	15 Kg Ayarlı Sürme Kapak Sistemi • 15 Kg Adjustable Sliding Door System 16-30 mm 111

105

WingSlide®

Sürme Katlanır Kapak Serisi • Sliding Foldable Door Series

WingSlide 7400	105-7400	25 Kg Ayarlı Katlanır Sürme Gardırop Sistemi • 25 Kg Adjustable Sliding System For Folding Doors 18 mm 116
WingSlide 7405	105-7405	25 Kg Ayarlı Katlanır Sürme Gardırop Sistemi • 25 Kg Adjustable Sliding System For Folding Doors 18 mm 117
WingSlide 7410	105-7410	15 Kg Ayarlı Katlanır Sürme Gardırop Sistemi • 15 Kg Adjustable Sliding System For Folding Doors 18 mm 118
WingSlide 7420	105-7420	40 Kg Ayarlı Katlanır Sürme Gardırop Sistemi • 40 Kg Adjustable Sliding System For Folding Doors 18 mm 119
WingSlide 7430	105-7430	40 Kg Ayarlı Katlanır Sürme Gardırop Sistemi • 40 Kg Adjustable Sliding System For Folding Doors 18 mm 120
WingSlide 7440	105-7440	40 Kg Ayarlı Katlanır Sürme Gardırop Sistemi • 40 Kg Adjustable Sliding System For Folding Doors 18 mm 121
WingSlide 7441	105-7441	40 Kg Ayarlı Katlanır Sürme Gardırop Sistemi • 40 Kg Adjustable Sliding System For Folding Doors 18 mm 122

108

Glassline®

Sürme Cam Kapak Serisi • Sliding Glass Door Series

Glassline 2	108-7020	20 Kg Ayarlı Sürme Yavaşlatıcılı Cam Kapak Sistemi 20 Kg Adjustable Soft Closing Sliding Glass Door System 4-5 mm 127
Glassline 7500	108-7500	25 Kg Ayarlı Alüminyum Çerçeve Sürgü Sistemi 25 Kg Adjustable Aluminium Frame Sliding System 4-6 mm 128
Glassline 7600	108-7600	15 Kg Ayarlı Sürme Cam Kapak Sistemi 15 Kg Adjustable Sliding Glass Door System 4 mm 129
Glassline 7700	108-7700	25 Kg Sürme Cam Kapak Sistemi 25 Kg Sliding Glass Door System 4-6 mm 130
Glassline 7702	108-7702	25 Kg Sürme Cam Kapak Sistemi 25 Kg Sliding Glass Door System 4-6 mm 131

109

Rigel®

Sürme Ray Dolap Serisi • Sliding Rail Wardrobe Series

Rigel 1	109-0251	50 Kg Ayarlı Sürme Pano Sistemi • 50 Kg Adjustable Sliding Panel System 4-8 mm 136
Rigel 2	109-0252	50 Kg Ayarlı Sürme Pano Sistemi • 50 Kg Adjustable Sliding Panel System 4-8 mm 137
Rigel 3	109-0253	50 Kg Ayarlı Sürme Pano Sistemi • 50 Kg Adjustable Sliding Panel System 4-8 mm 138
Rigel 4	109-0254	50 Kg Ayarlı Sürme Pano Sistemi • 50 Kg Adjustable Sliding Panel System 4-8 mm 139
Rigel 1801	109-1801	60 Kg Ayarlı Alüminyum Sürme Pano Sistemi • 60 Kg Adjustable Sliding Aluminium Panel System 4-8 mm 141

110 TvSlide® Sürme Tv Ünite Serisi • Sliding Tv Unit Series

TvSlide 5100	110-5100	45 Kg Ayarlı Tv Ünitesi Sürme Kapak Sistemi • 45 Kg Adjustable Tv Unit Sliding Door System 18-30 143
--------------	----------	--

117 Softline® Yavaşlatıcı Serisi • Soft Closers Series

Softline 6710	117-6710	100 Kg Yavaşlatıcı Sistem • 100 Kg Soft Closer System 149
Softline 6711	117-6711	100 Kg Yavaşlatıcı Sistem • 100 Kg Soft Closer System 149
Softline 6666	117-6666	60 Kg Yavaşlatıcı Sistem • 60 Kg Soft Closer System 150
Softline 6740	117-6740	60 Kg Yavaşlatıcı Sistem • 60 Kg Soft Closer System 150
Softline 6940	117-6940	40 Kg Yavaşlatıcı Sistem • 40 Kg Soft Closer System 151
Softline 6950	117-6950	50 Kg Yavaşlatıcı Sistem • 50 Kg Soft Closer System 151
Softline 6970	117-6970	70 Kg Yavaşlatıcı Sistem • 70 Kg Soft Closer System 152
Softline 6800	117-6800	80 Kg Yavaşlatıcı Sistem • 80 Kg Soft Closer System 152
Softline 6810	117-6810	80 Kg Yavaşlatıcı Sistem • 80 Kg Soft Closer System 153
Softline 6942	117-6942	50 Kg Yavaşlatıcı Sistem • 50 Kg Soft Closer System 153
Softline 6901	117-6901	50 Kg Yavaşlatıcı Sistem • 50 Kg Soft Closer System 154
Softline 6820	117-6820	80 Kg Yavaşlatıcı Sistem • 80 Kg Soft Closer System 154
Softline 6990	117-6990	80 Kg Yavaşlatıcı Sistem • 80 Kg Soft Closer System 155
Softline 6700	117-6700	80 Kg Yavaşlatıcı Sistem • 80 Kg Soft Closer System 155
Softline 6922	117-6922	50 Kg Yavaşlatıcı Sistem • 50 Kg Soft Closer System 156
Softline 6921	117-6921	70 Kg Yavaşlatıcı Sistem • 70 Kg Soft Closer System 156
Softline 6959	117-6959	50 Kg Yavaşlatıcı Sistem • 50 Kg Soft Closer System 157
Softline 1010	117-1010	Plastik Stoper • Plastic Stopper 158
Softline 1011	117-1011	Profil Plastik Ray Tapası • Profile Plastic Rail Plug 158
Softline 1050	117-1050	Plastik Kapak Çarpma Önleyici • Plastic Cover Anti-Shock 159
Softline 1220	117-1220	Profil Plastik Ray Tapası • Profile Plastic Rail Plug 159

118 Pulltens® Çek-Ger Serisi • Pull-Tension Series

Pulltens 1	118-0001	Metal Çek-Ger • Pull Tension Metal 164
Pulltens 2	118-0002	Metal Boy Çek-Ger • Pull Tension Metal 164
Pulltens 5	118-0005	Plastik Başlı Çek-Ger • Pull Tension Plastic 165
Pulltens 6	118-0006	Alüminyum Çek-Ger • Pull Tension Aluminium 165
Pulltens 7	118-0007	Alüminyum Zamak Başlı Çek-Ger • Zinc Pull Tension Aluminium 166
Pulltens 9	118-0009	Alüminyum Boy Çek-Ger • Pull Tension Aluminium 166
Pulltens 11	118-0011	Zamak Başlı Gizli Çek-Ger • Zinc Pull Tension Metal 167
Pulltens 12	118-0012	Metal Çek-Ger • Pull Tension Metal 167

119 BarnDoor® Üstten Askı Ahşap Sürme Kapı Serisi • Top Hanger Wooden Sliding Door Series

BarnDoor 8800	119-8800	60 Kg Ayarlı Üstten Askı Ahşap Sürme Kapı Sistemi 60 Kg Adjustable Top Hanger Wooden Sliding Door System 32-50 mm 172
BarnDoor 8810	119-8810	60 Kg Ayarlı Üstten Askı Ahşap Sürme Kapı Sistemi 60 Kg Adjustable Top Hanger Wooden Sliding Door System 32-50 mm 173
BarnDoor 8820	119-8820	80 Kg Ayarlı Çift Yöne Yavaşlatıcılı Sürme Kapı Sistemi 80 Kg Adjustable Sliding Door System - Two Way Soft Closing 32-50 mm 174
BarnDoor 8825	119-8825	50 Kg Ayarlı Çift Yöne Yavaşlatıcılı Sürme Kapı Sistemi 50 Kg Adjustable Sliding Door System - Two Way Soft Closing 32-50 mm 175
BarnDoor 8830	119-8830	80 Kg Ayarlı Çift Yöne Yavaşlatıcılı Sürme Kapı Sistemi 80 Kg Adjustable Sliding Door System - Two Way Soft Closing 32-50 mm 176
BarnDoor 8835	119-8835	50 Kg Ayarlı Çift Yöne Yavaşlatıcılı Sürme Kapı Sistemi 50 Kg Adjustable Sliding Door System - Two Way Soft Closing 32-50 mm 177
BarnDoor 8900	119-8900	60 Kg Ayarlı Üstten Askı Ahşap Sürme Kapı Sistemi 60 Kg Adjustable Top Hanger Wooden Sliding Door System 8-12 mm 179

BarnDoor 8920	119-8920	80 Kg Ayarlı Çift Yöne Yavaşlatıcılı Sürme Cam Kapı Sistemi 80 Kg Adjustable Sliding Glass Door System - Two Way Soft Closing.....8-12 mm.....	180
BarnDoor 8925	119-8925	50 Kg Ayarlı Çift Yöne Yavaşlatıcılı Sürme Cam Kapı Sistemi 50 Kg Adjustable Sliding Glass Door System - Two Way Soft Closing.....8-12 mm.....	181

120

DoorSlide®

Ahşap Sürme Kapı Serisi • Wooden Sliding Door Series

DoorSlide 1000	120-1000	80 Kg Ayarlı Coplanar Sürme Kapı Sistemi 80 Kg Adjustable Coplanar Sliding Door System35-50 mm.....	186
DoorSlide 8000	120-8000	40 Kg Ayarlı Çift Yöne Yavaşlatıcılı Sürme Kapı Sistemi 40 Kg Adjustable Sliding Door System - Two Way Soft Closing.....35-60 mm.....	189
DoorSlide 9010	120-9010	60 Kg Ayarlı Çift Yöne Yavaşlatıcılı Sürme Kapı Sistemi 60 Kg Adjustable Sliding Door System - Two Way Soft Closing.....25-60 mm.....	190
DoorSlide 9015	120-9015	60 Kg Ayarlı Çift Yöne Yavaşlatıcılı Sürme Kapı Sistemi 60 Kg Adjustable Sliding Door System - Two Way Soft Closing.....30-60 mm.....	191
DoorSlide 9012	120-9012	60 Kg Ayarlı Çift Yöne Yavaşlatıcılı Sürme Kapı Sistemi 60 Kg Adjustable Sliding Door System - Two Way Soft Closing.....25-60 mm.....	192
DoorSlide 9020	120-9020	40 Kg Ayarlı Çift Yöne Yavaşlatıcılı Sürme Kapı Sistemi 40 Kg Adjustable Sliding Door System - Two Way Soft Closing.....25-60 mm.....	193
DoorSlide 9080	120-9080	120 Kg Ayarlı Çift Yöne Yavaşlatıcılı Sürme Kapı Sistemi 120 Kg Adjustable Sliding Door System - Two Way Soft Closing.....25-60 mm.....	194
DoorSlide 9085	120-9085	120 Kg Ayarlı Çift Yöne Yavaşlatıcılı Sürme Kapı Sistemi 120 Kg Adjustable Sliding Door System - Two Way Soft Closing.....30-60 mm.....	195
DoorSlide 9090	120-9090	120 Kg Ayarlı Çift Yöne Yavaşlatıcılı Sürme Kapı Sistemi 120 Kg Adjustable Sliding Door System - Two Way Soft Closing.....25-60 mm.....	196
DoorSlide 9701	120-9701	120 Kg Ayarlı Tek Yöne Yavaşlatıcılı Sürme Kapı Sistemi 120 Kg Adjustable Sliding Door System - One Way Soft Closing.....20-60 mm.....	198
DoorSlide 9706	120-9706	120 Kg Ayarlı Tek Yöne Yavaşlatıcılı Sürme Kapı Sistemi 120 Kg Adjustable Sliding Door System - One Way Soft Closing.....30-60 mm.....	199
DoorSlide 9720	120-9720	120 Kg Ayarlı Çift Yöne Yavaşlatıcılı Sürme Kapı Sistemi 120 Kg Adjustable Sliding Door System - Two Way Soft Closing.....20-60 mm.....	200
DoorSlide 9725	120-9725	120 Kg Ayarlı Çift Yöne Yavaşlatıcılı Sürme Kapı Sistemi 120 Kg Adjustable Sliding Door System - Two Way Soft Closing.....30-60 mm.....	201
DoorSlide 7090	120-7090	80 Kg Ayarlı Sürme Kapı Sistemi 80 Kg Adjustable Sliding Door System.....18-50 mm.....	202
DoorSlide 7099	120-7099	80 Kg Ayarlı Sürme Kapı Sistemi Rulmanlı 80 Kg Adjustable Sliding Door System Has Ball Bearing18-50 mm.....	203
DoorSlide 7310	120-7310	51 Kg Ayarlı Sürme Kapı Sistemi 51 Kg Adjustable Sliding Door System.....18-50 mm.....	204
DoorSlide 7340	120-7340	60 Kg Ayarlı Sürme Kapı Sistemi 60 Kg Adjustable Sliding Door System.....18-50 mm.....	205
DoorSlide 7380	120-7380	80 Kg Ayarlı Sürme Kapı Sistemi Rulmanlı 80 Kg Adjustable Sliding Door System Has Ball Bearing18-50 mm.....	206
DoorSlide 9600	120-9600	160 Kg Ayarlı Sürme Kapı Sistemi 160 Kg Adjustable Sliding Door System.....18-50 mm.....	207
DoorSlide 9100	120-9100	250 Kg Ayarlı Sürme Kapı Sistemi 250 Kg Adjustable Sliding Door System.....40-50 mm.....	208
DoorSlide 9200	120-9200	250 Kg Ayarlı Sürme Kapı Sistemi 250 Kg Adjustable Sliding Door System.....40-50 mm.....	209
DoorSlide 9700	120-9700	120 Kg Ayarlı Sürme Kapı Sistemi 120 Kg Adjustable Sliding Door System.....20-60 mm.....	210
DoorSlide 9705	120-9705	120 Kg Ayarlı Sürme Kapı Sistemi 120 Kg Adjustable Sliding Door System.....30-60 mm.....	211
DoorSlide 7120	120-7120	120 Kg Ayarlı Sürme Kapı Sistemi 120 Kg Adjustable Sliding Door System.....25-50 mm.....	212

121	DoorSync® Wood	Ahşap Senkronize Sürme Kapı Serisi • Wooden Funicular Sliding Door Series
DoorSync 9800	121-9800	120 Kg Ayarlı Halatlı Sürme Kapı Sistem 120 Kg Adjustable Funicular Sliding Door System.....20-60 mm218
DoorSync 9810	121-9810	80 Kg Ayarlı Halatlı Sürme Kapı Sistem 80 Kg Adjustable Funicular Sliding Door System.....20-50 mm219
DoorSync 9801	121-9801	120 Kg Ayarlı Tek Yöne Yavaşlatıcı Halatlı Sürme Kapı Sistemi 120 Kg Adjustable Funicular Sliding Door System - One Way Soft Closing20-60 mm220
DoorSync 9820	121-9820	120 Kg Ayarlı Çift Yöne Yavaşlatıcı Halatlı Sürme Kapı Sistemi 120 Kg Adjustable Funicular Sliding Door System - Two Way Soft Closing20-60 mm221
DoorSync 9830	121-9830	60 Kg Ayarlı Çift Yöne Yavaşlatıcı Halatlı Sürme Kapı Sistemi 60 Kg Adjustable Funicular Sliding Door System - Two Way Soft Closing25-60 mm222
DoorSync 9840	121-9840	40 Kg Ayarlı Çift Yöne Yavaşlatıcı Halatlı Sürme Kapı Sistemi 40 Kg Adjustable Funicular Sliding Door System - Two Way Soft Closing25-60 mm223
DoorSync 9850	121-9850	60 Kg Ayarlı Çift Yöne Yavaşlatıcı Halatlı Sürme Kapı Sistemi 60 Kg Adjustable Funicular Sliding Door System - Two Way Soft Closing25-60 mm224
DoorSync 9880	121-9880	120 Kg Ayarlı Çift Yöne Yavaşlatıcı Halatlı Sürme Kapı Sistemi 120 Kg Adjustable Funicular Sliding Door System - Two Way Soft Closing25-60 mm226
DoorSync 9890	121-9890	120 Kg Ayarlı Çift Yöne Yavaşlatıcı Halatlı Sürme Kapı Sistemi 120 Kg Adjustable Funicular Sliding Door System - Two Way Soft Closing25-60 mm227
122	MasterFold® - Midfold®	Ahşap Katlanır Sürme Kapı Serisi • Wooden Foldable Sliding Door Series
Domino 90	122-0090	45 Kg 90 Derece Açılır Katlanır Kapı Donanımı • 45 Kg 90 Degree Bi-Folding Door Hardware36-44 mm232
Domino 180	122-0180	45 Kg 180 Derece Açılır Katlanır Kapı Donanımı • 45 Kg 180 Degree Bi-Folding Door Hardware36-44 mm233
MasterFold 9042	122-9042	40 Kg Ayarlı Katlanır Sürme Kapı Sistemi • 40 Kg Adjustable Foldable Sliding Door Mechanism.....36-60 mm234
MasterFold 9044	122-9044	40 Kg Ayarlı Katlanır Sürme Kapı Sistemi • 40 Kg Adjustable Foldable Sliding Door Mechanism.....36-60 mm235
MasterFold 9060	122-9060	60 Kg Ayarlı Katlanır Sürme Kapı Sistemi • 60 Kg Adjustable Foldable Sliding Door Mechanism.....36-60 mm236
MidFold 9062	122-9062	60 Kg Ayarlı Katlanır Sürme Kapı Sistemi • 60 Kg Adjustable Foldable Sliding Door Mechanism.....36-60 mm237
MasterFold 160	122-9300	160 Kg Ayarlı Katlanır Sürme Kapı Sistemi • 160 Kg Adjustable Foldable Sliding Door Mechanism.....40-50 mm238
MidFold 160	122-9500	160 Kg Ayarlı Katlanır Sürme Kapı Sistemi • 160 Kg Adjustable Foldable Sliding Door Mechanism.....40-50 mm239
MasterFold	122-1050-1800	Katlanır Kapı Kilit Mekanizması • Folding Door Lock Mechanism240
MasterFold	122-1052-1820	Yer Soketi • Dust Proof Strike241
123	GlassDoor®	Cam Sürme Kapı Serisi • Glass Door Sliding Series
GlassDoor 9906	123-9906	60 Kg Ayarlı Çift Yöne Yavaşlatıcı Sürme Cam Kapı Sistemi 60 Kg Adjustable Sliding Glass Door System - Two Way Soft Closing.....8-12 mm250
GlassDoor 9912	123-9912	120 Kg Ayarlı Çift Yöne Yavaşlatıcı Sürme Cam Kapı Sistemi 120 Kg Adjustable Sliding Glass Door System - Two Way Soft Closing.....8-12 mm251
GlassDoor 9910	123-9910	80 Kg Ayarlı Sürme Cam Kapı Sistemi 80 Kg Adjustable Sliding Glass Door System8-12 mm252
GlassDoor 9911	123-9911	80 Kg Ayarlı Sürme Cam Kapı Sistemi 80 Kg Adjustable Sliding Glass Door System8-12 mm253
GlassDoor 9900	123-9900	120 Kg Ayarlı Sürme Cam Kapı Sistemi 120 Kg Adjustable Sliding Glass Door System8-12 mm254
GlassDoor 9901	123-9901	120 Kg Ayarlı Sürme Cam Kapı Sistemi 120 Kg Adjustable Sliding Glass Door System8-12 mm255
GlassDoor 9030	123-9030	60 Kg Ayarlı Çift Yöne Yavaşlatıcı Sürme Cam Kapı Sistemi 60 Kg Adjustable Sliding Glass Door System - Two Way Soft Closing.....8-12 mm256
GlassDoor 9035	123-9035	60 Kg Ayarlı Çift Yöne Yavaşlatıcı Sürme Cam Kapı Sistemi 60 Kg Adjustable Sliding Glass Door System - Two Way Soft Closing.....8-12 mm257
GlassDoor 9902	123-9902	120 Kg Ayarlı Tek Yöne Yavaşlatıcı Sürme Cam Kapı Sistemi 120 Kg Adjustable Sliding Glass Door System - One Way Soft Closing.....8-12 mm258

GlassDoor 9903	123-9903	120 Kg Ayarlı Tek Yöne Yavaşlatıcı Sürme Cam Kapı Sistemi 120 Kg Adjustable Sliding Glass Door System - One Way Soft Closing.....8-12 mm.....259
GlassDoor 9920	123-9920	120 Kg Ayarlı Çift Yöne Yavaşlatıcı Sürme Cam Kapı Sistemi 120 Kg Adjustable Sliding Glass Door System - Two Way Soft Closing.....8-12 mm.....260
GlassDoor 9921	123-9921	120 Kg Ayarlı Çift Yöne Yavaşlatıcı Sürme Cam Kapı Sistemi 120 Kg Adjustable Sliding Glass Door System - Two Way Soft Closing.....8-12 mm.....261
GlassDoor 9980	123-9980	120 Kg Ayarlı Çift Yöne Yavaşlatıcı Sürme Cam Kapı Sistemi 120 Kg Adjustable Sliding Glass Door System - Two Way Soft Closing.....8-12 mm.....262
GlassDoor 9985	123-9985	120 Kg Ayarlı Çift Yöne Yavaşlatıcı Sürme Cam Kapı Sistemi 120 Kg Adjustable Sliding Glass Door System - Two Way Soft Closing.....8-12 mm.....263

124

DoorSync® Glass

Cam Senkronize Sürme Kapı Serisi - Funicular Glass Door Series

DoorSync 9935	124-9935	40 Kg Ayarlı Çift Yöne Yavaşlatıcı Halatlı Sürme Cam Kapı Sistemi 40 Kg Adjustable Funicular Sliding Glass Door System.....8-12 mm.....268
DoorSync 9940	124-9940	80 Kg Ayarlı Halatlı Sürme Cam Kapı Sistemi 80 Kg Adjustable Funicular Sliding Glass Door System.....8-12 mm.....269
DoorSync 9950	124-9950	120 Kg Ayarlı Halatlı Sürme Cam Kapı Sistemi 120 Kg Adjustable Funicular Sliding Glass Door System.....8-12 mm.....270
DoorSync 9951	124-9951	120 Kg Ayarlı Halatlı Tek Yöne Yavaşlatıcı Sürme Cam Kapı Sistemi 120 Kg Adjustable Funicular Sliding Glass Door System - One Way Soft Closing.....8-12 mm.....271
DoorSync 9960	124-9960	120 Kg Ayarlı Halatlı Çift Yöne Yavaşlatıcı Sürme Cam Kapı Sistemi 120 Kg Adjustable Funicular Sliding Glass Door System - Two Way Soft Closing.....8-12 mm.....272
DoorSync 9981	124-9981	120 Kg Ayarlı Halatlı Çift Yöne Yavaşlatıcı Sürme Cam Kapı Sistemi 120 Kg Adjustable Funicular Sliding Glass Door System - Two Way Soft Closing.....8-12 mm.....273

127

MultiDoor®

Teleskopik Ahşap Sürme Kapı Serisi - Telescopic Wooden Sliding Door Series

MultiDoor 100	127-0100	80 Kg Ayarlı Teleskopik Sürme Kapı Sistemi 80 Kg Adjustable Telescopic Sliding Door Systems.....30-50 mm.....278
MultiDoor 150	127-0150	80 Kg Ayarlı Teleskopik Halatlı Sürme Kapı Sistemi 80 Kg Adjustable Telescopic Funicular Sliding Door Systems.....30-50 mm.....279
MultiDoor 200	127-0200	80 Kg Ayarlı Tek Yöne Yavaşlatıcı Teleskopik Sürme Kapı Sistemi 80 Kg Adjustable Telescopic Sliding Door Systems - One Way Soft Closing.....30-50 mm.....280
MultiDoor 250	127-0250	80 Kg Ayarlı Tek Yöne Yavaşlatıcı Halatlı Teleskopik Sürme Kapı Sistemi 80 Kg Adjustable Telescopic Funicular Sliding Door Systems - One Way Soft Closing.....30-50 mm.....281
MultiDoor 260	127-0260	80 Kg Ayarlı Çift Yöne Yavaşlatıcı Halatlı Teleskopik Sürme Kapı Sistemi 80 Kg Adjustable Telescopic Funicular Sliding Door Systems - Two Way Soft Closing.....30-50 mm.....282
MultiDoor 400	127-0400	60 Kg Ayarlı Çift Yöne Yavaşlatıcı Teleskopik Sürme Kapı Sistemi 60 Kg Adjustable Telescopic Sliding Door Systems - Two Way Soft Closing.....30-50 mm.....284
MultiDoor 450	127-0450	60 Kg Ayarlı Çift Yöne Yavaşlatıcı Halatlı Teleskopik Sürme Kapı Sistemi 60 Kg Adjustable Telescopic Funicular Sliding Door Systems - Two Way Soft Closing.....30-50 mm.....285
MultiDoor 500	127-0500	120 Kg Ayarlı Çift Yöne Yavaşlatıcı Halatlı Teleskopik Sürme Kapı Sistemi 120 Kg Adjustable Telescopic Funicular Sliding Door Systems - Two Way Soft Closing.....30-50 mm.....286
MultiDoor 550	127-0550	120 Kg Ayarlı Çift Yöne Yavaşlatıcı Halatlı Teleskopik Sürme Kapı Sistemi 120 Kg Adjustable Telescopic Funicular Sliding Door Systems - Two Way Soft Closing.....30-50 mm.....287

130

Underline®

Kapı Altı Giyotin Serisi - Door Seal Series

Underline 200	130-0200	Kapı Altı Giyotini • Door Seal - Internal.....292
Underline 210	130-0210	Yangın Dayanımlı Kapı Altı Giyotini • Door Seal Fire Protection - Internal.....293
Underline 220	130-0220	Kapı Altı Giyotini-Dıştan • Door Seal - External.....294
Underline 230	130-0230	Yangına Dayanımlı Kapı Altı Giyotini - Dıştan • Door Seal Fire Protection-External.....295
Underline 300	130-0300	Kapı Altı Giyotini • Door Seal - Internal.....296

131	Door Hardware	Kapı Donanımları Serisi • Door Hardware Series
Door Hardware	131-0100	Kilit Karşılığı Cebi • Lock Pocket300
Door Hardware	131-0110	Kilit Karşılığı Cebi • Lock Pocket300
Door Hardware	131-0120	Kilit Karşılığı Cebi • Lock Pocket301
Door Hardware	131-0130	Kilit Karşılığı Cebi • Lock Pocket301
Door Hardware	131-0200	Otomatik Kapı Sürgüsü (Yönsüz) • Automatic Door Bolt (Nondirectional).....302
Door Hardware	131-0210	Yer Soketi • Dust Proof Strike303
135	MagicLift®	Gardırop Donanımları Serisi • Wardrobe Equipments Series
MagicLift 1100	135-1100	15 Kg Gardırop Asansörü • 15 Kg Lift For Wardrobe.....306
MagicLift 1110	135-1110	10 Kg Gardırop Asansörü • 10 Kg Lift For Wardrobe.....307
MagicLift 1101	135-1101	Gardırop Asansörü Montaj Aparatı • Lift For Wardrobe Assembly Kit308
MagicLift 1200	135-1200	12 Kg Gardırop Asansörü • 12 Kg Lift For Wardrobe.....310
140	Ventil® Aluminium	Alüminyum Dekoratif Menfez Serisi • Aluminium Air Ventilation Cover Series
Ventil Aluminium	140-0440	Alüminyum Bar Menfez • Aluminium Air Ventilation Cover316
Ventil Aluminium	140-0460	Alüminyum Bar Menfez • Aluminium Air Ventilation Cover316
Ventil Aluminium	140-0480	Alüminyum Bar Menfez • Aluminium Air Ventilation Cover316
Ventil Aluminium	140-0900	Alüminyum Koza Menfez • Aluminium Air Ventilation Cover318
Ventil Aluminium	140-0700	Alüminyum Koza Menfez • Aluminium Air Ventilation Cover318
Ventil Aluminium	140-0750	Alüminyum Koza Menfez • Aluminium Air Ventilation Cover318
Ventil Aluminium	140-0950	Alüminyum Kare Menfez • Aluminium Air Ventilation Cover.....319
Ventil Aluminium	140-0800	Alüminyum Kare Menfez • Aluminium Air Ventilation Cover.....319
Ventil Aluminium	140-0850	Alüminyum Kare Menfez • Aluminium Air Ventilation Cover.....319
141	Ventil® Plastic	Plastik Dekoratif Menfez Serisi • Plastic Air Ventilation Cover Series
Ventil Plastic	141-0680	Plastik Menfez • Plastic Air Ventilation Cover • 76 x 430 mm.....324
Ventil Plastic	141-0650	Plastik Menfez • Plastic Air Ventilation Cover • 70 x 466 mm.....324
Ventil Plastic	141-0630	Plastik Menfez • Plastic Air Ventilation Cover • 51 x 215 mm.....325
Ventil Plastic	141-0640	Plastik Menfez • Plastic Air Ventilation Cover • 35 x 164 mm.....325
Ventil Plastic	141-0670	Plastik Menfez • Plastic Air Ventilation Cover • 50 x 50 mm.....326
Ventil Plastic	141-0600	Plastik Menfez • Plastic Air Ventilation Cover • 200 x 30 mm.....326
Ventil Plastic	141-0620	Plastik Menfez • Plastic Air Ventilation Cover • Ø 34 mm.....327
Ventil Plastic	141-0625	Plastik Menfez • Plastic Air Ventilation Cover • Ø 34 mm.....327
Ventil Plastic	141-0660	Plastik Menfez • Plastic Air Ventilation Cover • Ø 44 mm.....328
Ventil Plastic	141-0610	Plastik Menfez • Plastic Air Ventilation Cover • Ø 60 mm.....328
Ventil Plastic	141-0700	Plastik Menfez • Plastic Air Ventilation Cover • 447 x 55 mm.....329
Ventil Plastic	141-0750	Plastik Menfez • Plastic Air Ventilation Cover • 378 x 58,5 mm.....329
142	TurnTable®	Döner Tabla Mekanizma Serisi • Swivel Plate - Turnable Table Series
TurnTable 60	142-0060	Döner Tabla Mekanizması / Swivel Plate - Turnable Table Mechanism.....334
TurnTable 61	142-0061	Döner Tabla Mekanizması / Swivel Plate - Turnable Table Mechanism335
TurnTable 62	142-0062	Döner Tabla Mekanizması / Swivel Plate - Turnable Table Mechanism335
TurnTable 65	142-0065	Döner Tabla Mekanizması / Swivel Plate - Turnable Table Mechanism.....336
TurnTable 67	142-0067	Döner Tabla Mekanizması / Swivel Plate - Turnable Table Mechanism.....336
TurnTable 68	142-0068	Döner Tabla Mekanizması / Swivel Plate - Turnable Table Mechanism337
TurnTable 70	142-0070	Konum Sabitleyici • Swivel Location Stabilizer.....337
TurnTable 75	142-0075	Döner Tabla Mekanizması / Swivel Plate - Turnable Table Mechanism.....338
TurnTable 81	142-0081	Konum Sabitleyici • Swivel Location Stabilizer.....338

143	Master+	Mobilya Aksesuarları • Furniture Accessories	
Master+	151-0001	Alt Pvc Profil • Bottom Pvc Profile.....	342
Master+	151-0002	Üst Pvc Profil • Top Pvc Profile.....	342
Master+	143-1328-001	Tezgah Önü Tapası • Banco Return To Plug.....	342
Master+	143-1328-002	Tezgah Önü Tapası • Banco Return To Plug.....	342
Master+	143-2413	Plastik Askı Boru Flaşı • Hanger Pipe Flange.....	343
Master+	143-7056	120 Kg Baza Taşıyıcı Teker • Bed Base Carrier Roller.....	343
link+	143-1000	Panel Bileşeni • Panel Component.....	344
link+	143-1010	Panel Bileşeni • Panel Component.....	344
link+	143-1020	Panel Bileşeni • Panel Component.....	345
link+	143-1030	Panel Bileşeni • Panel Component.....	345
link+	143-1040	Panel Bileşeni • Panel Component.....	346
link+	143-1050	Panel Bileşeni • Panel Component.....	346
link+	143-1060	Panel Bileşeni • Panel Component.....	347
link+	143-1070	Panel Bileşeni • Panel Component.....	347
144	Feet	Koltuk ve Baza Ayakları Serisi • Furniture Feet Series	
Feet	144-0001	Alüminyum Teleskopik Stand • Aluminium Telescopic Stand.....	350
Feet	144-0129	Ayarlı Baza Mekanizması • Adjustable Bed Base Mechanism.....	351
Feet	144-0115	Alüminyum Sunta Destek Ayak • Aluminium Furniture Feet • W 25 X 25 mm.....	351
Feet	144-0120	Alüminyum Baza Köşe Ayak • Aluminium Bed Base Corner Feet.....	351
Feet	144-0121	Alüminyum Baza Orta Ayak • Aluminium Bed Base Central Feet.....	351
Feet	144-0127	Alüminyum Baza Ayak • Aluminium Furniture (Bed Base) Feet Ø 30 mm.....	352
Feet	144-0131	Alüminyum Baza Ayak • Aluminium Bed Base Feet • W 38 X 38 mm.....	352
Feet	144-0123	Alüminyum Baza Ayak • Aluminium Bed Base Feet • W 25 X 25 mm.....	352
Feet	144-0124	Alüminyum Orta Ayak • Aluminium Furniture Feet • W 25 X 25 mm.....	352
Feet	144-0125	Alüminyum Ayarlı Baza Ayak • Adjustable Bed Base Feet Ø 30 mm.....	353
Feet	144-0126	Alüminyum Ayarlı Baza Orta Ayak • Adjustable Bed Base Central Feet Ø 30 mm.....	353
Feet	144-0132	Alüminyum Baza Ayak • Aluminium Bed Base Feet W 40 X 40 mm.....	353
Feet	144-0147	Alüminyum Baza Ayak • Aluminium Bed Base Feet Ø 50 mm.....	353
150	Alüminyum Profiller • Aluminium Profiles		
Teknik Bilgi / Technical Data		Alüminyum Profiller • Aluminium Profiles.....	355
160	HingeTech Serisi / HingeTech Series		
HingeTech 0800	160-0800	80 Kg Gizli Kapı Menteşesi • 80 Kg Concealed Hinge.....	358
HingeTech	-	122-9300-1410-507 / Çelik Menteşe • Steel Hinge.....	360
HingeTech	-	122-9061-1300-505 / Çelik Menteşe • Steel Hinge.....	360
	Setbox Paketleme • Packaging		362
	Çalışma Koşulları • Working Conditions		364
	EN 1527 Euronorm Ürün Kalite Kodları • Euronorm Quality Codes of Products		365
	Ürün Teşhir Standları • Product Display Stands		366
	Anlaşılabilir Kredi Kartları / Doğrudan Borçlandırma Sistemi - DBS • Credit Card / Credit System		368
	Önemli Notlar • Important Notes		370
	Kapak Ağırlığı Hesaplama Tablosu • Door Weight Calculation Table		372
	B2B • Business to Business		374

Yenilikler

INNOVATIONS

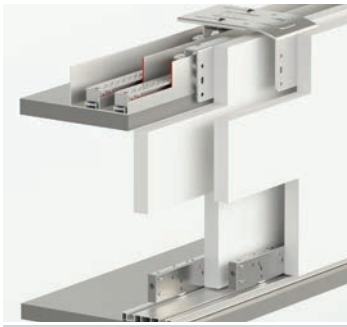

102-0200

Page 52

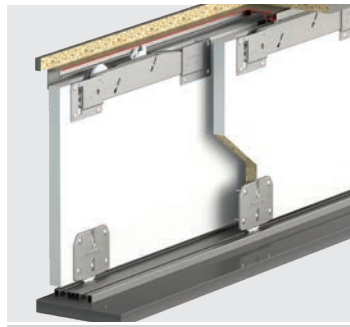

103-1010

Page 60

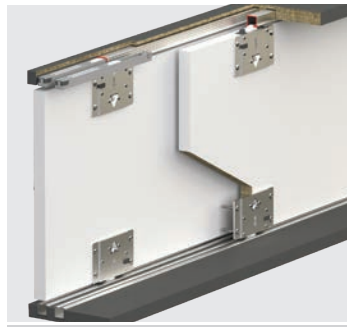

103-1040

Page 63



103-1050

Page 64



103-1070

Page 65

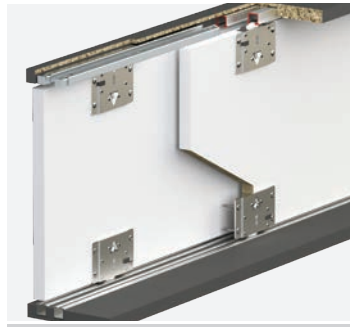

103-1080

Page 66



103-1090

Page 67



103-1100

Page 68



103-1110

Page 69

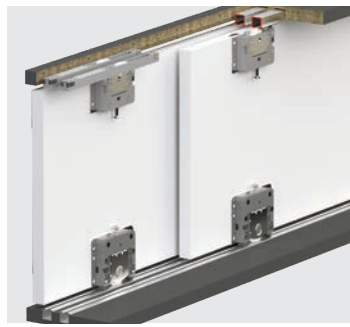

103-1120

Page 70

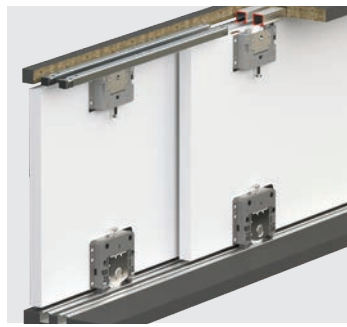

103-1130

Page 71



103-1140

Page 72

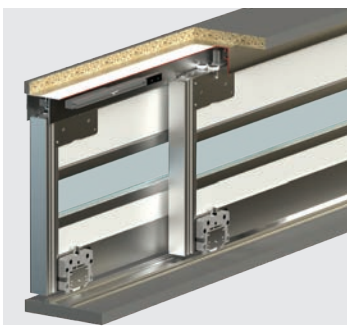

103-1150

Page 74

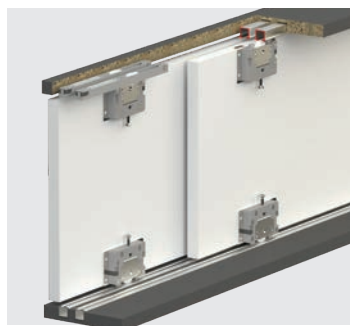

103-1160

Page 75j

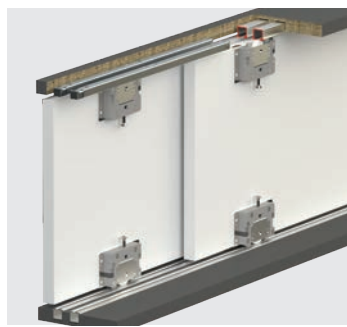

103-1170

Page 76

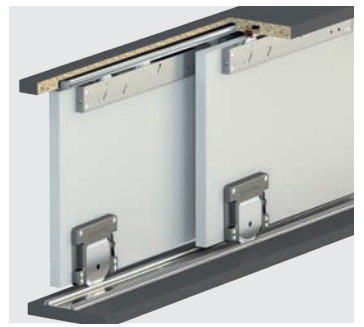

103-1180

Page 77

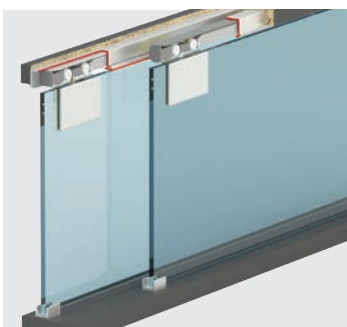

108-7020

Page 127

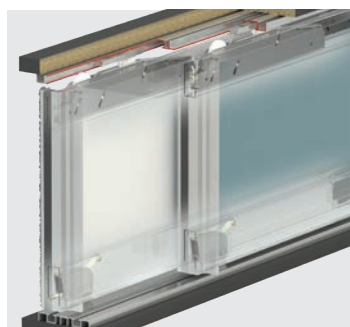

109-0251

Page 136

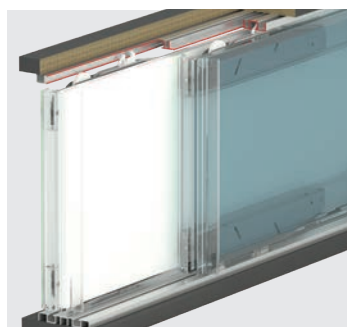

109-0252

Page 137



117-1050

Page 159

Yenilikler

INNOVATIONS



117-6711

Page 149



117-6959

Page 157



119-8810

Page 173

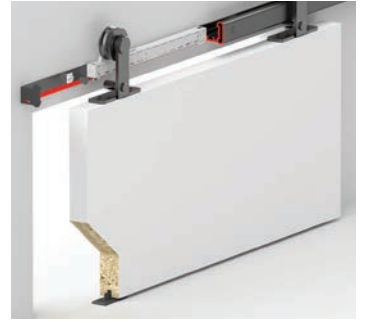

119-8830

Page 176



119-8835

Page 177



120-1000

Page 186



120-8000

Page 189

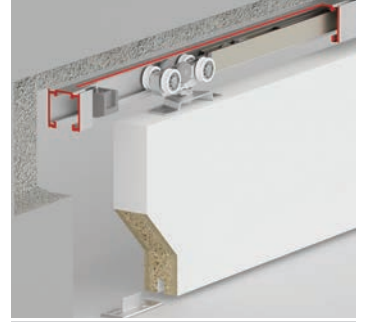

120-9080

Page 194

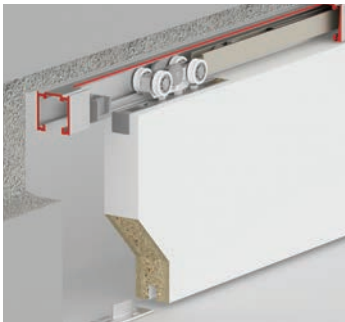

120-9085

Page 195



120-9090

Page 196



121-9880

Page 226



121-9890

Page 227



122-0090

Page 232

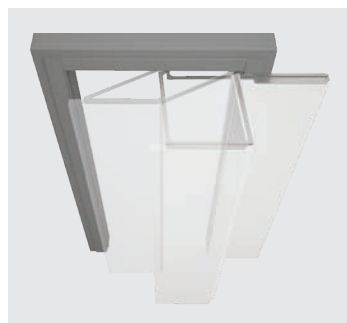

122-0180

Page 233



122-9042

Page 234



122-9044

Page 235



122-9060

Page 236



122-9062

Page 237



122-1050

Page 240



122-1052

Page 241

Yenilikler

INNOVATIONS



123-9906

Page 250

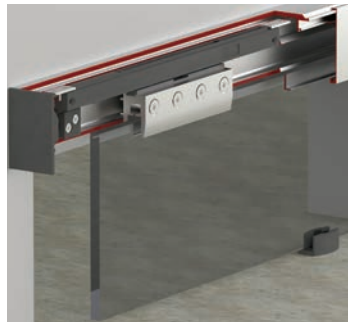

123-9912

Page 251



123-9980

Page 262

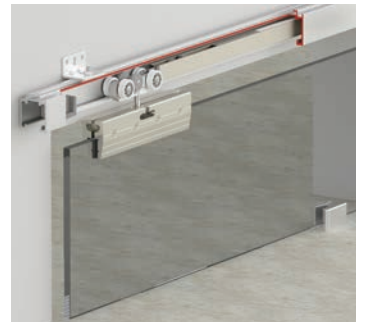

123-9985

Page 263

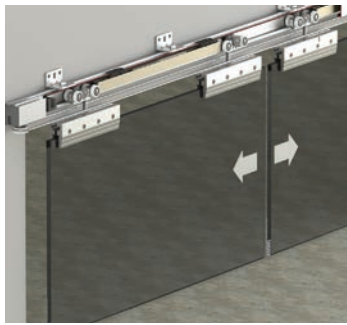

124-9981

Page 273

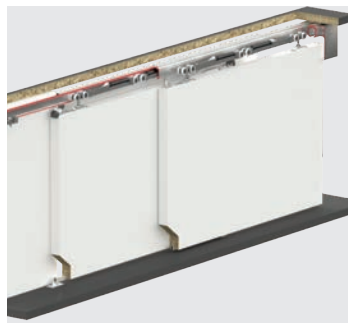

127-0262

Page 282



127-0502

Page 286



127-0552

Page 287

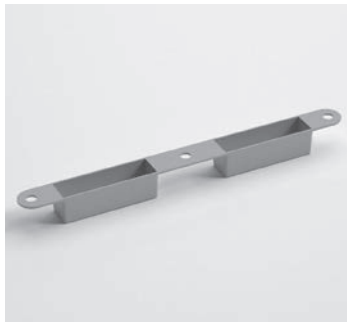

131-0120

Page 301



131-0130

Page 301



131-0200

Page 302



131-0210

Page 303



135-1200-3610

Page 310



135-1200-3620

Page 310

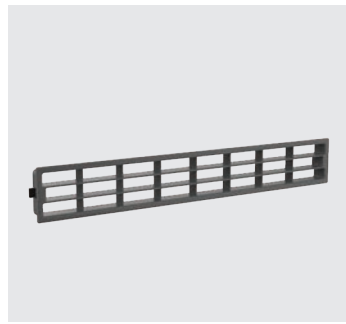

141-0700

Page 329

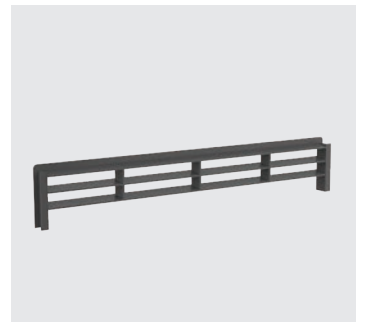

141-0750

Page 329

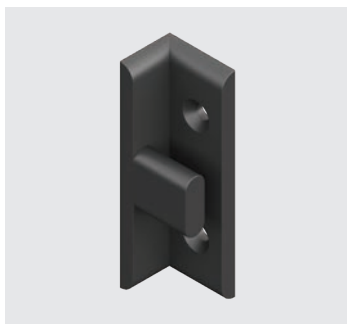

143-1000

Page 344



143-1010

Page 344



143-1020

Page 345



143-1030

Page 345

Yenilikler

INNOVATIONS



143-1040

Page 346

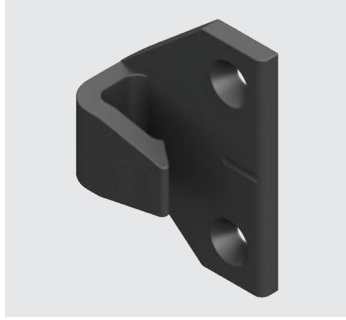

143-1050

Page 346

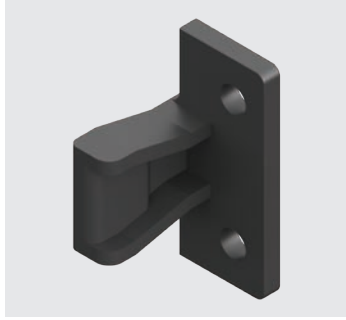

143-1060

Page 347



143-1070

Page 347

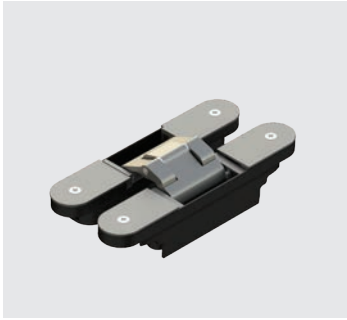

160-0800

Page 358

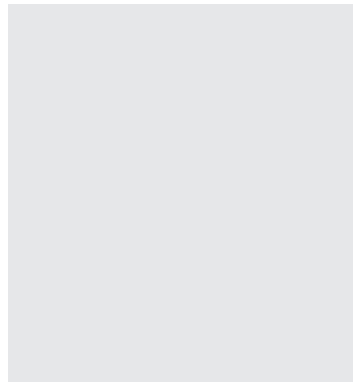
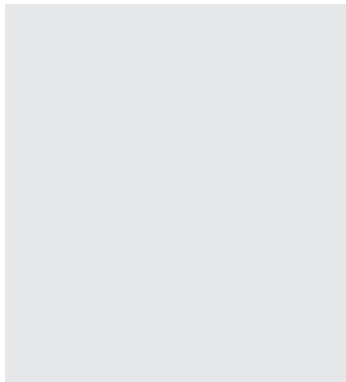
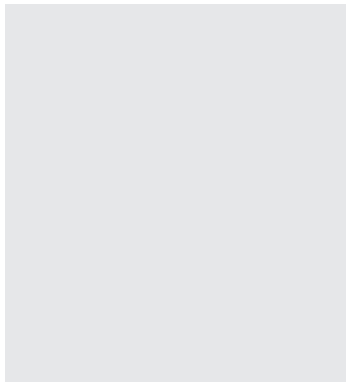
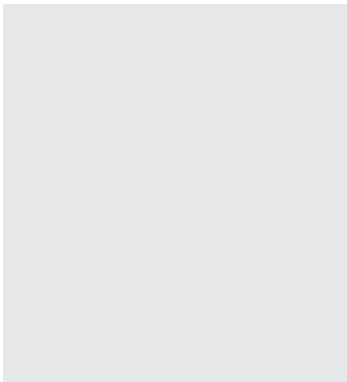
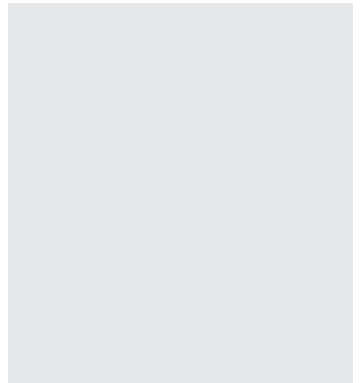
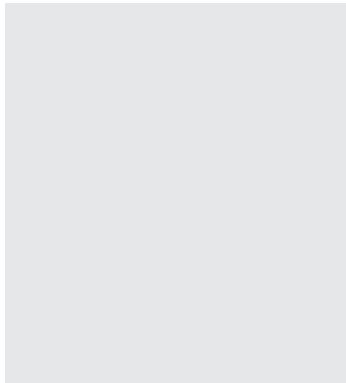
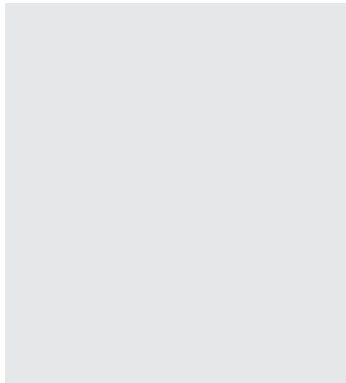
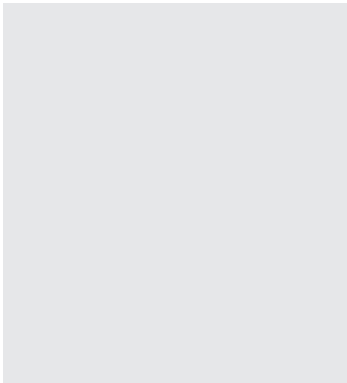
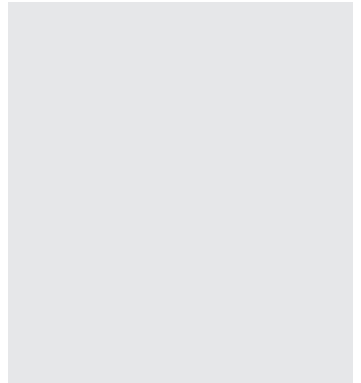
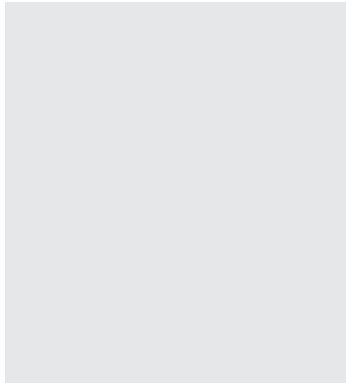
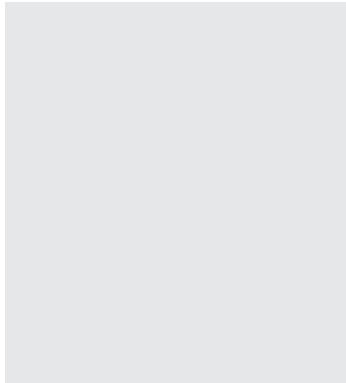
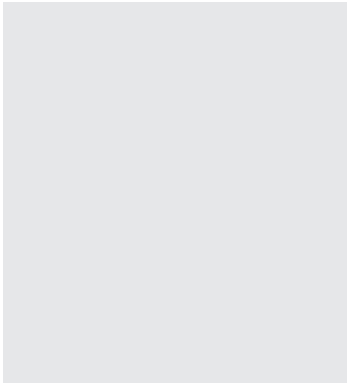
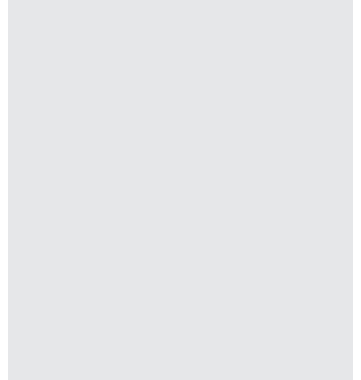
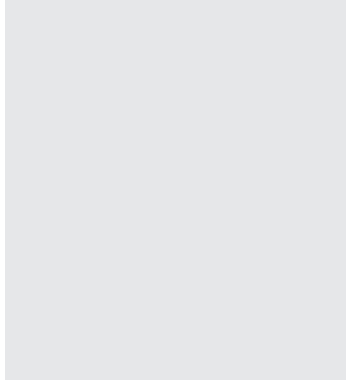
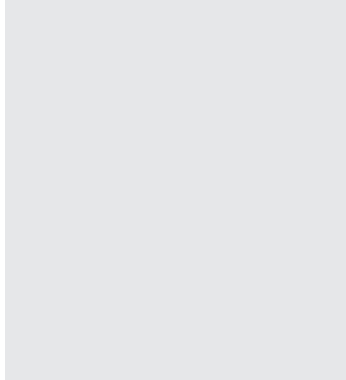

Group 101

Coplanar[®]

Hemyüz Sürme Gardırop Serisi

Coplanar Sliding Wardrobe Series

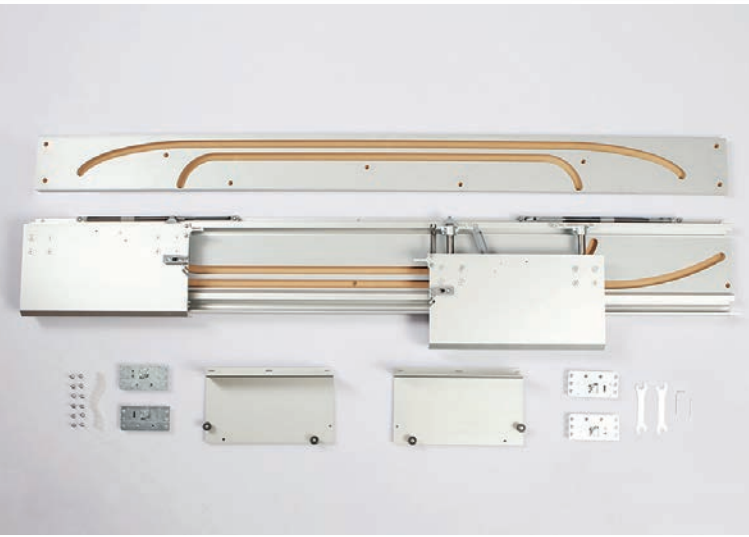

Bu serideki tüm ürünleri incelemek için QR kodu okutabilirsiniz.

You can analyze the QR code to see all the products in these series.

Coplanar 8888

101-8888

40 KG AYARLI GARDIROP HEMYÜZ SÜRME KAPAK SİSTEMİ
40 KG ADJUSTABLE COPLANAR SLIDING WARDROBE SYSTEM



Bilgi / Information

- Kapak yüksekliği 220 cm önerilir.
- Maksimum 40 kg / 1 kapak.
- Tek kanat uygulamalar için lütfen müşteri temsilciniz ile görüşünüz.

- Max. height of 220 cm is suitable for wardrobes.
- Maximum 40 kg / 1 door.
- For one wing applications please contact.

Yavaşlatıcı Alternatifi / Soft Closer Alternative

- Sistem üzerinde kapanış yönünde yavaşlatıcı mevcuttur.
- Sisteme haricen yavaşlatıcı uygulanamamaktadır.
- Soft closer is available in the direction of closing on the system.
- Soft closer can not be applied to the system.



101-8888 1 Set İçeriği / 1 Set Includes



Kulp Profilleri / Handle Profiles

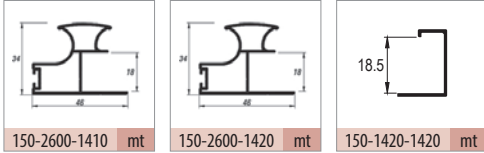

Opsiyonel Aksesuar / Optional Accessories

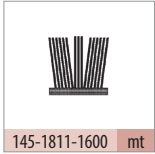

Teknik Detay / Technical Detail

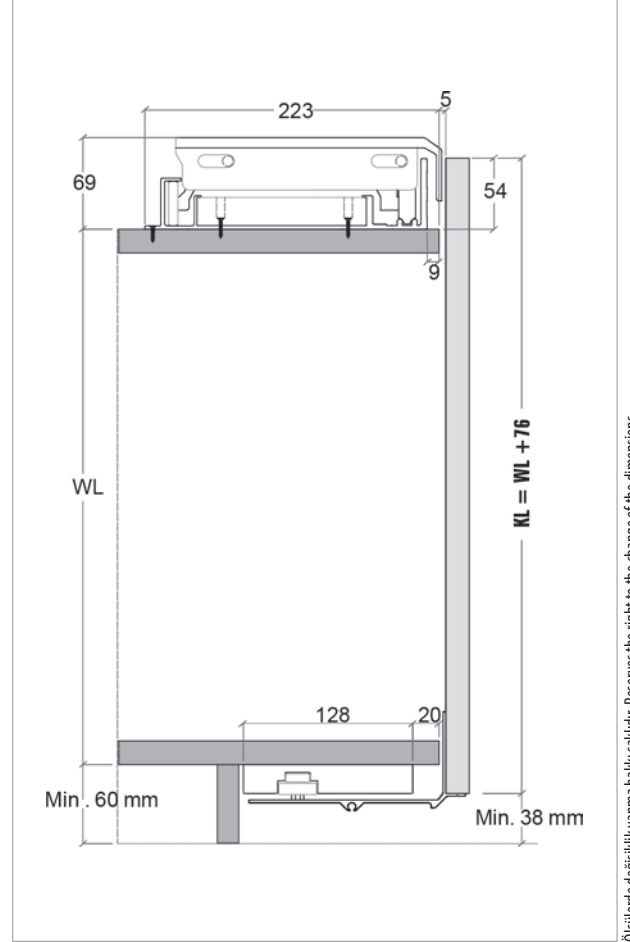

Ölçülerde değişiklik yapma hakkı saklıdır. Reserves the right to the change of the dimensions.

Kod / Code No	Açıklama / Description	Renk / Colour	Birim / Unit			Profil mt. / Profiles mt.	Bağ / Bnd.
101-8888-3410-1600	Sürme Gardırop Sistemi / Coplanar Sliding Wardrobe System / 1600 mm	Gri / Grey	2 Kapak / 1 Set	1	12	- - -	-
101-8888-3410-1800	Sürme Gardırop Sistemi / Coplanar Sliding Wardrobe System / 1800 mm	Gri / Grey	2 Kapak / 1 Set	1	12	- - -	-
101-8888-3410-2000	Sürme Gardırop Sistemi / Coplanar Sliding Wardrobe System / 2000 mm	Gri / Grey	2 Kapak / 1 Set	1	12	- - -	-
101-8888-3410-2200	Sürme Gardırop Sistemi / Coplanar Sliding Wardrobe System / 2200 mm	Gri / Grey	2 Kapak / 1 Set	1	12	- - -	-
101-8888-3410-2400	Sürme Gardırop Sistemi / Coplanar Sliding Wardrobe System / 2400 mm	Gri / Grey	2 Kapak / 1 Set	1	12	- - -	-
145-1811-1600	Kıl Fital / Ec-Wf Hair Wick	Gri / Grey	mt.	300	7.200	- - 3,0	-
150-2600-1410	Alüminyum Kulp Profili / Aluminium Handle Profile	Eloksal / Mat Anodized	mt.	-	-	- - 3,0	6 ad/pcs
150-2600-1420	Alüminyum Kulp Profili / Aluminium Handle Profile	Parlak / Bright	mt.	-	-	- - 3,0	6 ad/pcs
150-1420-1420	Alüminyum Kapama Profili / Aluminium Closure Profile	Parlak / Bright	mt.	-	-	- - 3,0	10 ad/pcs

Group 102

TopSlide®

Sürme Gardırop Serisi

Sliding Wardrobe Series



Bu serideki tüm ürünleri incelemek için QR kodu okutabilirsiniz.



You can analyze the QR code to see all the products in these series.

	OEM Kod OEM Code	Ürün Kodu Product Code	Sistem Tipi System Type	Panel Tipi Panel Type	Fren Yönü Brake Direc.	Panel mm	Taşıma Kg Capacity Kg	Video	Üst Ray Upper Rail	Alt Ray Lower Rail	Kapak Adeti Number of Doors	Alt Baza mm Sub-Base Distance mm	Yavaşlatıcı Dahil Soft Closer Including	Kapak Yükseklik Length of Door mm
1	102-8220	TopSlide 8220				16 - 20	100	✓	150-7234	150-7225	2 - 3	80 mm	✓	LW + 108 mm
2	102-8232	TopSlide 8232				18 - 30	100	✓	150-7234	150-7225	2 - 3	80 mm	✓	LW + 108 mm
3	102-8235	TopSlide 8235				18 - 35	100	✓	150-7234	150-7225	2 - 3	80 mm	✓	LW + 108 mm
4	102-8240	TopSlide 8240				18 - 40	100	✓	150-7234	150-7225	2 - 3	80 mm	✓	LW + 108 mm
5	102-8250	TopSlide 8250				18 - 50	100	✓	150-7234	150-7225	2 - 3	80 mm	✓	LW + 108 mm
6	102-8223	TopSlide 8223				16 - 20	100	✓	150-7234	150-7225	3	80 mm	✓	LW + 108 mm
7	102-8233	TopSlide 8233				18 - 30	100	✓	150-7234	150-7225	3	80 mm	✓	LW + 108 mm
8	102-8320	TopSlide 8320				16 - 18	100	✓	150-7234	150-7520	2 - 3	-	✓	LW + 55 mm
9	102-8080	TopSlide 8080				18 - 28	100	✓	150-7220	150-7225	2 - 3	-	Optional	LW + 84 mm
10	102-8040	TopSlide 8040				18	70	✓	150-7216	150-7225	2 - 3	60 mm	Optional	LW + 84 mm
11	102-8010	TopSlide 8010				18	60		150-7202	150-7200	2 - 3	80 mm	Optional	LW + 88 mm
12	102-7320	TopSlide 7320				16 - 22	60		150-7222	150-7242	2 - 3	74 mm	Optional	LW + 18 mm
13	102-8030	TopSlide 8030				16 - 25	60	✓	150-7210	150-7212	2 - 3	60 mm	Optional	-
14	102-8400	TopSlide 8400				16 - 25	60	✓	150-7211	150-7213	2 - 3	-	Optional	-
15	102-0190	TopSlide SRG 190				16 - 50	70	✓	150-7232	150-7108	2 - 3	-	✓	LW + 42 mm
16	102-0195	TopSlide SRG 195				16 - 50	50	✓	150-7232	150-7108	2 - 3	-	✓	LW + 42 mm
17	102-0200	TopSlide SRG 200				16 - 50	50	✓	150-7232	150-2003	2	-	✓	-

- Verilen ölçüler bağlayıcı değildir. Önerilen kurulum ölçüleridir. Albatır ürün özelliklerinde haber vermeden değişiklik yapabilir.
- The given dimension are not binding. These are recommended asamble dimensions. Albatır can make alteration to product specification without notice.



TopSlide 8232

<p>SINCE 1976</p>	 <p>Bearing Systems</p>	<p>EN 1527 100.000 CYCLES TEST</p> 	<p>R</p> <p>The Sliding System</p>
-----------------------	--	--	---



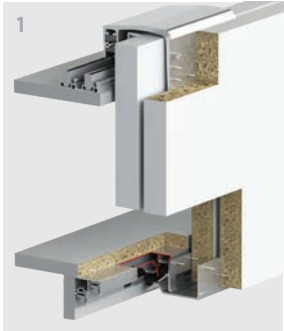

102-8220



102-8232



102-8235



102-8240

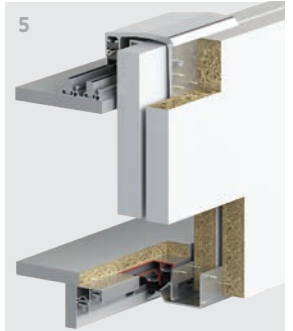

102-8250



102-8223



102-8233



102-8320

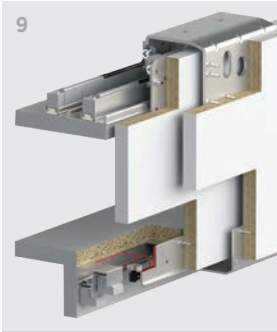

102-8080

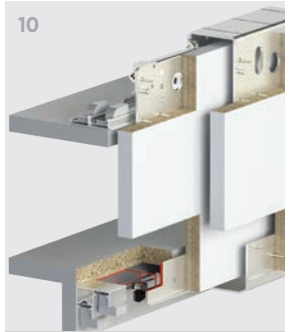

102-8040

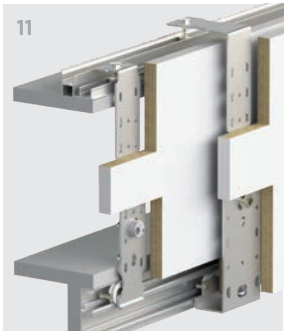

102-8010

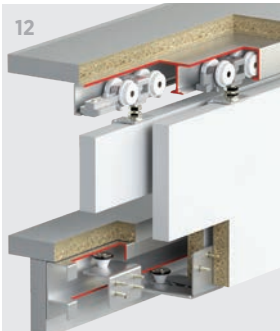

102-7320

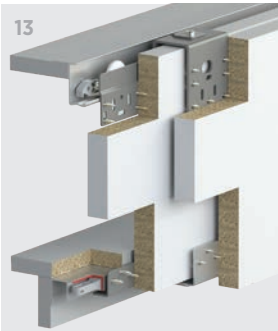

102-8030

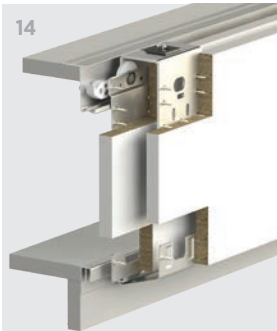

102-8400

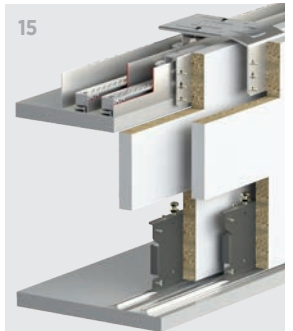

102-0190

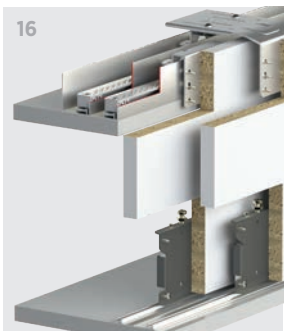

102-0195

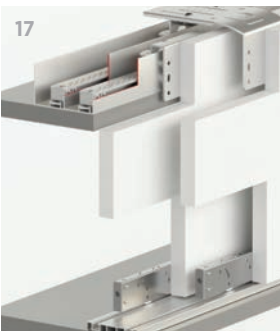

102-0200

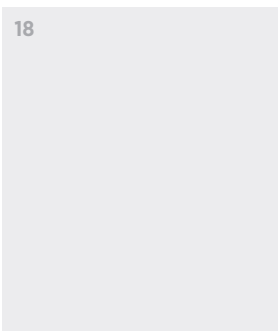

18

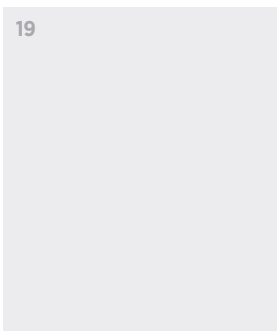

19

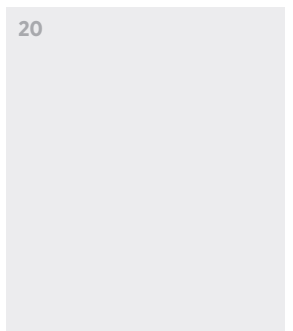

20

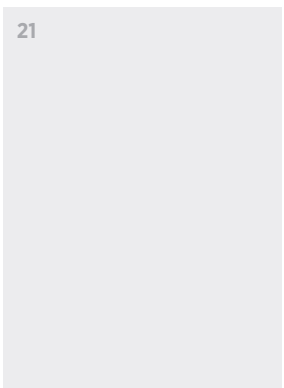

21

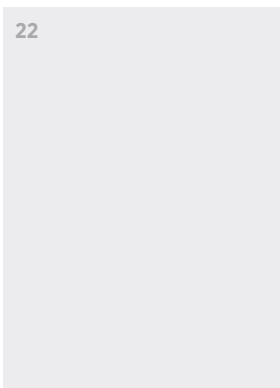

22

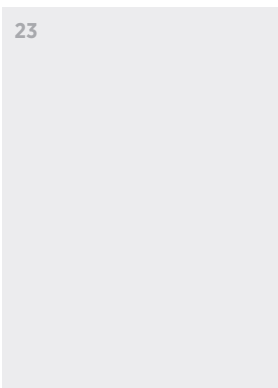

23

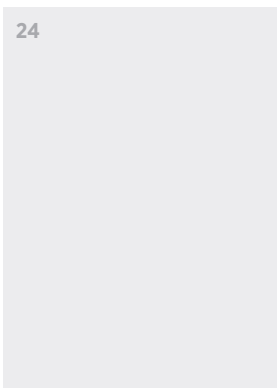

24

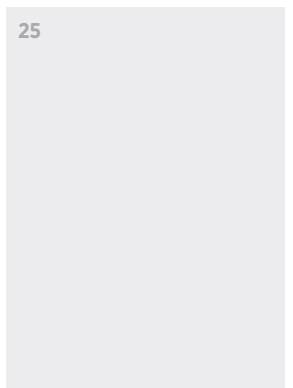

25

TopSlide 8220

102-8220

100 KG AYARLI SÜRME GARDİROP SİSTEMİ
100 KG ADJUSTABLE SLIDING WARDROBE SYSTEM



Bilgi / Information

- 1 Kutu İçeriği : 1 iç kapak + 1 dış kapak + 4 ad üst yavaşlatıcı + 4 ad alt yavaşlatıcı
- In 1 box : 1 internal door + 1 external door + 4 pcs Top soft closers
+ 4 pcs bottom soft closers



102-8220 1 Set İçeriği / 1 Set Includes

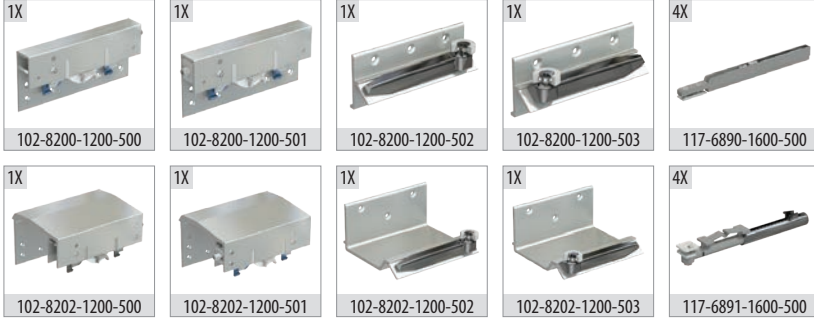

102-8203 Opsiyonel 3. İç Kapak / Optional 3. Internal Door

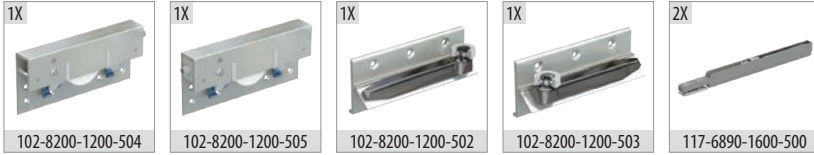

Ray Profilleri / Rail Profiles

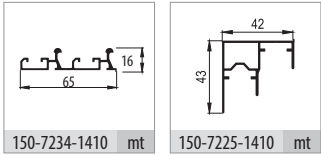

Kulp Profilleri / Handle Profiles

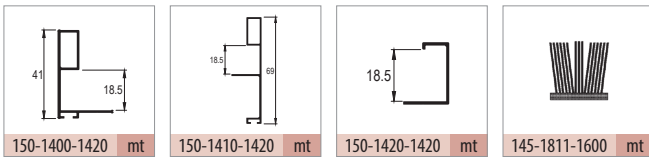

Teknik Detay / Technical Detail

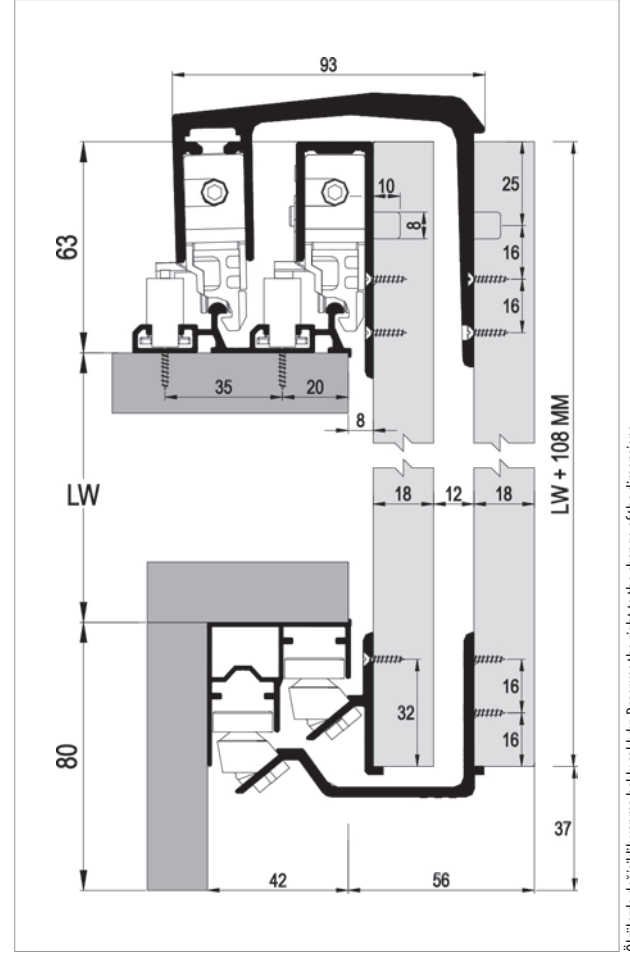

Ölçülerde değişiklik yapma hakkı saklıdır. Reserves the right to the change of the dimensions.

Kod / Code No	Açıklama / Description	Renk / Colour	Birim / Unit			Profil mt. / Profiles mt.			Bağ / Bnd.
102-8220-1200	Sürme Gardırop Sistemi / Sliding Wardrobe System	Silver	2 Kapak / 1 Set	6	144	-	-	-	-
102-8203-1200	Sürme Gardırop Sistemi 3. Kapak / Sliding Wardrobe System 3. Door	Silver	1 Kapak / 1 Kit	8	400	-	-	-	-
145-1811-1600	Kıl Fıtil / Ec-Wf Hair Wick	Gri / Grey	mt.	300	7.200	-	-	-	-
150-7234-1410	Alüminyum Üst Ray Profili / Aluminium Top Rail Profile	Eloksal / Mat Anodized	mt.	-	-	2,0	2,5	3,0	6 ad/pcs
150-7225-1410	Alüminyum Alt Ray Profili / Aluminium Bottom Rail Profile	Eloksal / Mat Anodized	mt.	-	-	2,0	2,5	3,0	6 ad/pcs
150-1400-1420	Alüminyum Kulp Profili / Aluminium Handle Profile	Parlak / Bright	mt.	-	-	-	2,7	-	10 ad/pcs
150-1410-1420	Alüminyum Kulp Profili / Aluminium Handle Profile	Parlak / Bright	mt.	-	-	-	2,7	-	10 ad/pcs
150-1420-1420	Alüminyum Kapama Profili / Aluminium Closure Profile	Parlak / Bright	mt.	-	-	-	-	3,0	10 ad/pcs

TopSlide 8232

102-8232

100 KG AYARLI SÜRME GARDİROP SİSTEMİ

100 KG ADJUSTABLE SLIDING WARDROBE SYSTEM



Bilgi / Information

- 1 Kutu İçeriği : 1 iç kapak + 1 dış kapak + 4 ad üst yavaşlatıcı + 4 ad alt yavaşlatıcı
- In 1 box : 1 internal door + 1 external door + 4 pcs Top soft closers + 4 pcs bottom soft closers



102-8232 1 Set İçeriği / 1 Set Includes

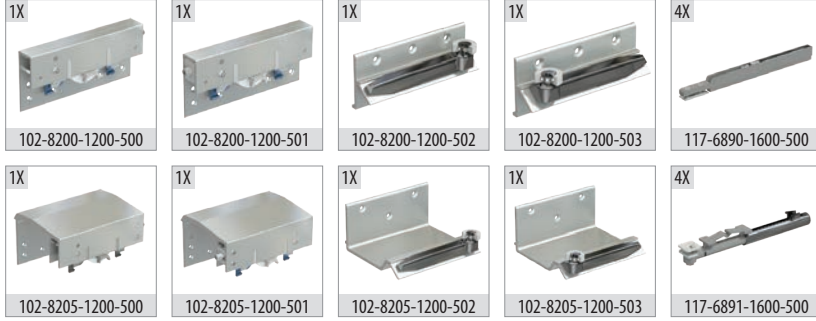

102-8203 Opsiyonel 3. İç Kapak / Optional 3. Internal Door



Ray Profilleri / Rail Profiles

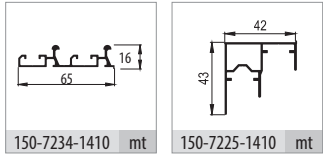

Aksesuar / Accessory

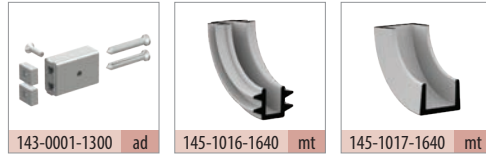

Kulp Profilleri / Handle Profiles

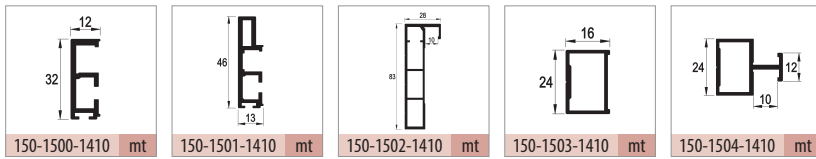

Teknik Detay / Technical Detail

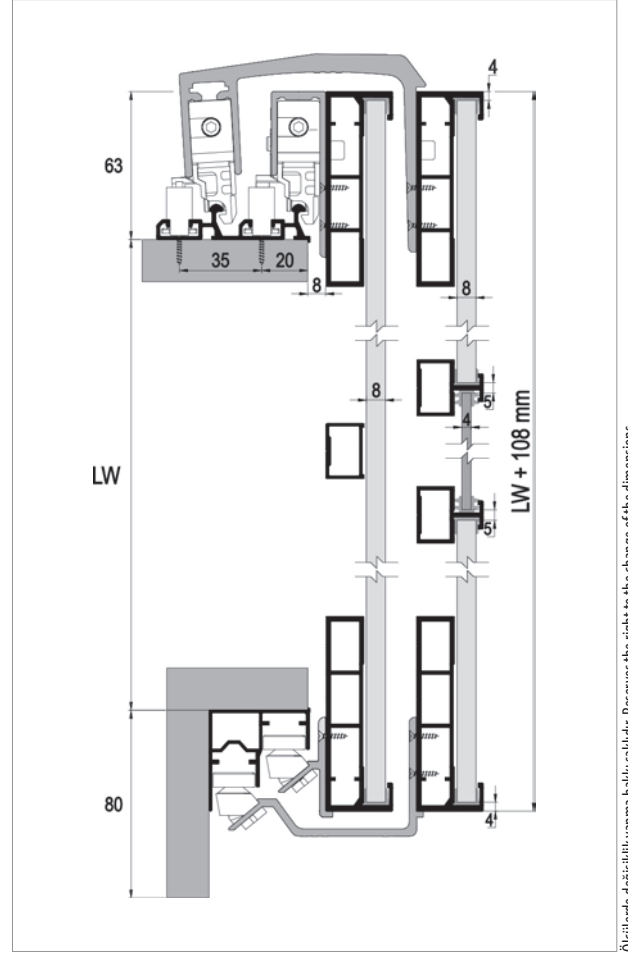

Ölçülerde değişiklik yapma hakkı saklıdır. Reserves the right to the change of the dimensions.

Kod / Code No	Açıklama / Description	Renk / Colour	Birim / Unit			Profil mt. / Profiles mt.	Bağ / Bnd.
102-8232-1200	Sürme Gardirop Sistemi / Sliding Wardrobe System	Silver	2 Kapak / 1 Set	6	144	- - -	-
102-8203-1200	Sürme Gardirop Sistemi 3. Kapak / Sliding Wardrobe System 3. Door	Silver	1 Kapak / 1 Kit	8	400	- - -	-
143-0001-1300	Bağlantı Kiti / Connection Kit	Silver	1 Adet / 1 Pcs			- - -	-
145-1016-1640	4 mm Cam Fitali / 4 mm Glass Wick	Şeffaf / Transparan	mt.	100	3.600	- - -	-
145-1017-1640	8 mm Sunta Fitali / 8 mm Panel Wick	Şeffaf / Transparan	mt.	100	3.600	- - -	-
150-7234-1410	Alüminyum Üst Ray Profili / Aluminium Top Rail Profile	Eloksal / Mat Anodized	mt.	-	-	2,0 2,5 3,0	6 ad/pcs
150-7225-1410	Alüminyum Alt Ray Profili / Aluminium Bottom Rail Profile	Eloksal / Mat Anodized	mt.	-	-	2,0 2,5 3,0	6 ad/pcs
150-1500-1410	Alüminyum Çerçeve Profili / Aluminium Frame Profile	Eloksal / Mat Anodized	mt.	-	-	- - 3,0	6 ad/pcs
150-1501-1410	Alüminyum Çerçeve Profili / Aluminium Frame Profile	Eloksal / Mat Anodized	mt.	-	-	- - 3,0	6 ad/pcs
150-1502-1410	Alüminyum Çerçeve Profili / Aluminium Frame Profile	Eloksal / Mat Anodized	mt.	-	-	- - 3,0	4 ad/pcs
150-1503-1410	Alüminyum Çerçeve Profili / Aluminium Frame Profile	Eloksal / Mat Anodized	mt.	-	-	- - 3,0	12 ad/pcs
150-1504-1410	Alüminyum Çerçeve Profili / Aluminium Frame Profile	Eloksal / Mat Anodized	mt.	-	-	- - 3,0	6 ad/pcs

TopSlide 8235

102-8235

100 KG AYARLI SÜRME GARDİROP SİSTEMİ
100 KG ADJUSTABLE SLIDING WARDROBE SYSTEM

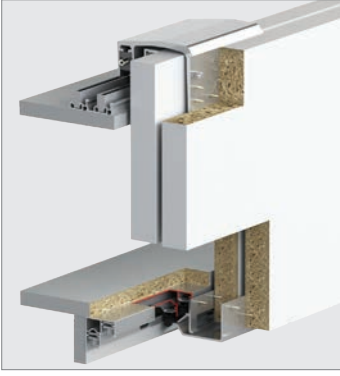

Bilgi / Information

- 1 Kutu İçeriği : 1 iç kapak + 1 dış kapak + 4 ad üst yavaşlatıcı + 4 ad alt yavaşlatıcı
- In 1 box : 1 internal door + 1 external door + 4 pcs Top soft closers + 4 pcs bottom soft closers



102-8235 1 Set İçeriği / 1 Set Includes

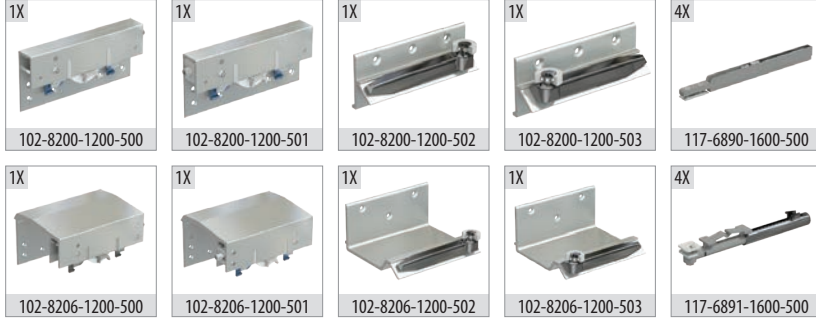

102-8203 Opsiyonel 3. İç Kapak / Optional 3. Internal Door



Ray Profilleri / Rail Profiles

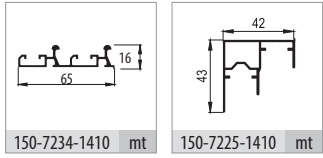

Uygulama / Application



Teknik Detay / Technical Detail

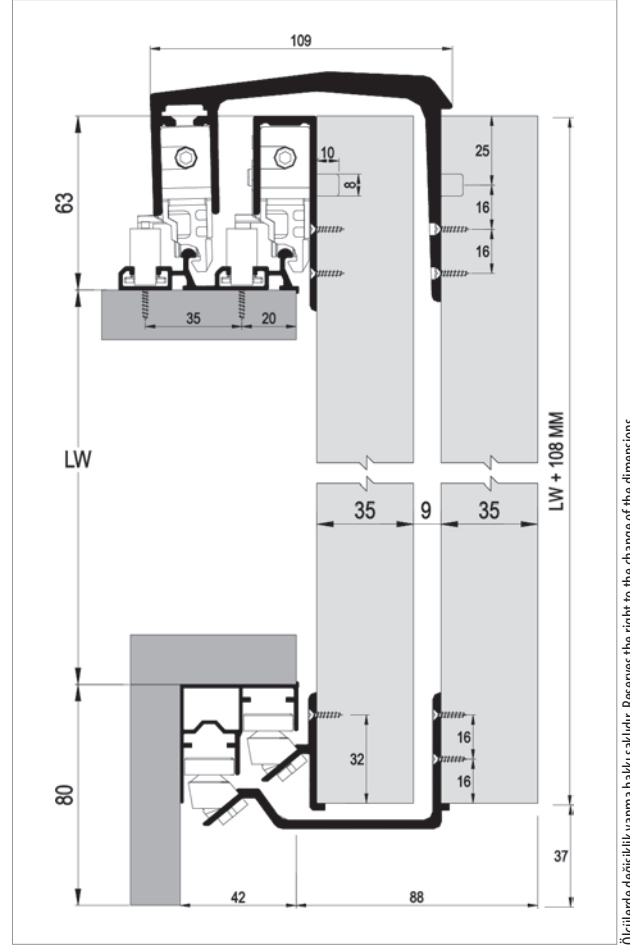

Ölçülerde değişiklik yapma hakkı saklıdır. Reserves the right to the change of the dimensions.

Kod / Code No	Açıklama / Description	Renk / Colour	Birim / Unit			Profil mt. / Profiles mt.			Bağ / Bnd.
102-8235-1200	Sürme Gardrop Sistemi / Sliding Wardrobe System	Silver	2 Kapak / 1 Set	6	144	-	-	-	-
102-8203-1200	Sürme Gardrop Sistemi 3. Kapak / Sliding Wardrobe System 3. Door	Silver	1 Kapak / 1 Kit	8	400	-	-	-	-
150-7234-1410	Alüminyum Üst Ray Profili / Aluminium Top Rail Profile	Eloksal / Mat Anodized	mt.	-	-	2,0	2,5	3,0	6 ad/pcs
150-7225-1410	Alüminyum Alt Ray Profili / Aluminium Bottom Rail Profile	Eloksal / Mat Anodized	mt.	-	-	2,0	2,5	3,0	6 ad/pcs

TopSlide 8240

102-8240

100 KG AYARLI SÜRME GARDİROP SİSTEMİ
100 KG ADJUSTABLE SLIDING WARDROBE SYSTEM



Bilgi / Information

- 1 Kutu İçeriği : 1 iç kapak + 1 dış kapak + 4 ad üst yavaşlatıcı + 4 ad alt yavaşlatıcı
- In 1 box : 1 internal door + 1 external door + 4 pcs Top soft closers + 4 pcs bottom soft closers



102-8240 1 Set İçeriği / 1 Set Includes



102-8203 Opsiyonel 3. İç Kapak / Optional 3. Internal Door

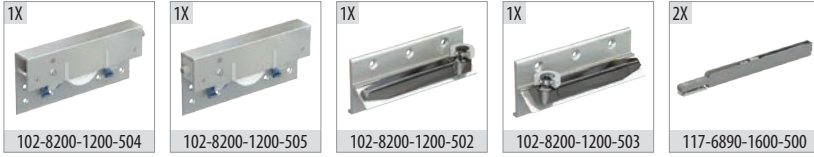

Ray Profilleri / Rail Profiles

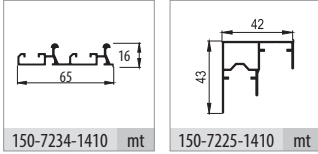

Uygulama / Application



Teknik Detay / Technical Detail

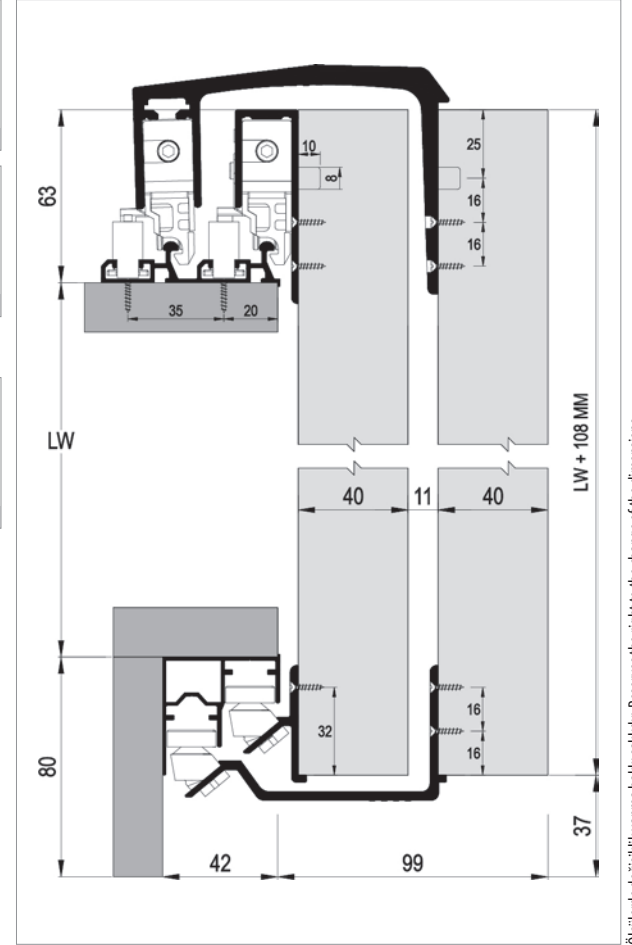

Ölçülerde değişiklik yapma hakkı saklıdır. Reserves the right to the change of the dimensions.

Kod / Code No	Açıklama / Description	Renk / Colour	Birim / Unit			Profil mt. / Profiles mt.	Bağ / Bnd.
102-8240-1200	Sürme Gardırop Sistemi / Sliding Wardrobe System	Silver	2 Kapak / 1 Set	6	144	- - -	-
102-8203-1200	Sürme Gardırop Sistemi 3. Kapak / Sliding Wardrobe System 3. Doors	Silver	1 Kapak / 1 Kit	8	400	- - -	-
150-7234-1410	Alüminyum Üst Ray Profili / Aluminium Top Rail Profile	Eloksal / Mat Anodized	mt.	-	-	2,0 2,5 3,0	6 ad/pcs
150-7225-1410	Alüminyum Alt Ray Profili / Aluminium Bottom Rail Profile	Eloksal / Mat Anodized	mt.	-	-	2,0 2,5 3,0	6 ad/pcs

TopSlide 8250

102-8250

100 KG AYARLI SÜRME GARDİROP SİSTEMİ
100 KG ADJUSTABLE SLIDING WARDROBE SYSTEM



Bilgi / Information

- 1 Kutu İçeriği : 1 iç kapak + 1 dış kapak + 4 ad üst yavaşlatıcı + 4 ad alt yavaşlatıcı
- In 1 box : 1 internal door + 1 external door + 4 pcs Top soft closers + 4 pcs bottom soft closers



102-8250 1 Set İçeriği / 1 Set Includes

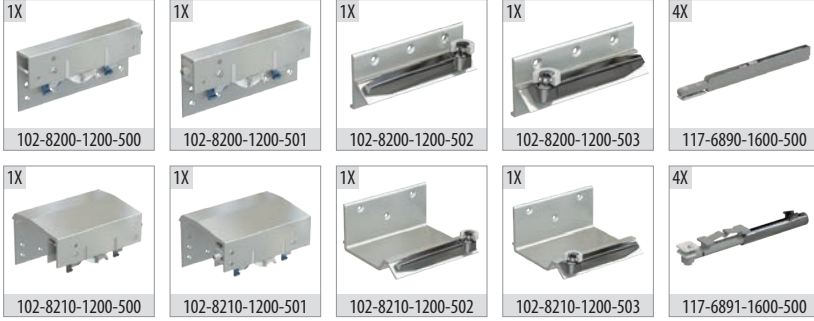

102-8203 Opsiyonel 3. İç Kapak / Optional 3. Internal Door

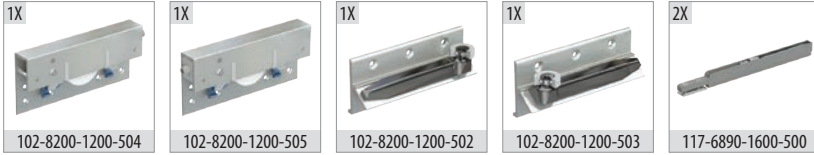

Ray Profilleri / Rail Profiles

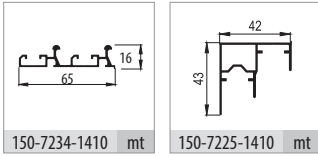

Uygulama / Application



Teknik Detay / Technical Detail

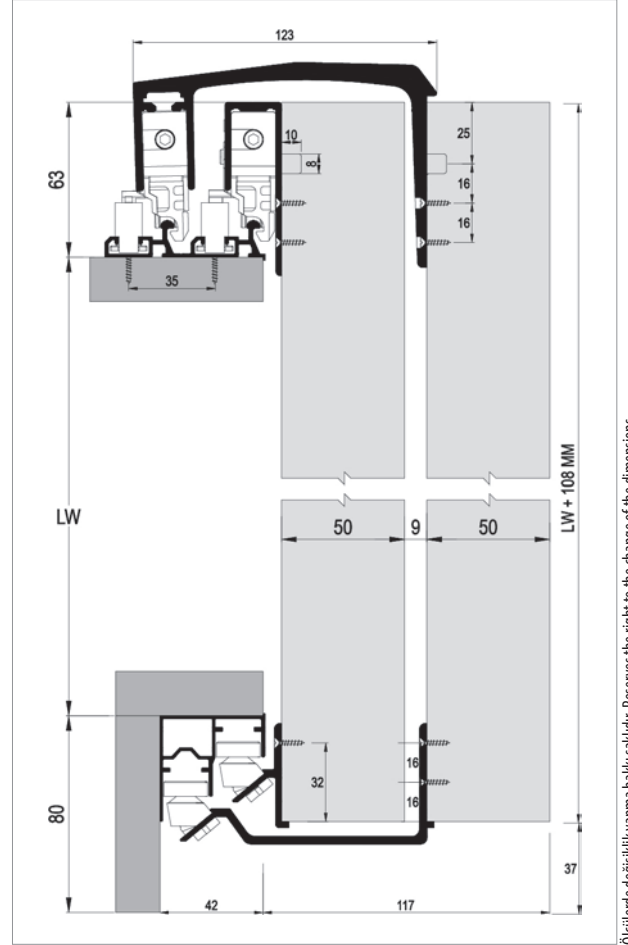

Ölçülerde değişiklik yapma hakkı saklıdır. Reserves the right to the change of the dimensions.

Kod / Code No	Açıklama / Description	Renk / Colour	Birim / Unit			Profil mt. / Profiles mt.			Bağ / Bnd.
102-8250-1200	Sürme Gardrop Sistemi / Sliding Wardrobe System	Silver	2 Kapak / 1 Set	6	144	-	-	-	-
102-8203-1200	Sürme Gardrop Sistemi 3. Kapak / Sliding Wardrobe System 3. Doors	Silver	1 Kapak / 1 Kit	8	400	-	-	-	-
150-7234-1410	Alüminyum Üst Ray Profili / Aluminium Top Rail Profile	Eloksal / Mat Anodized	mt.	-	-	2,0	2,5	3,0	6 ad/pcs
150-7225-1410	Alüminyum Alt Ray Profili / Aluminium Bottom Rail Profile	Eloksal / Mat Anodized	mt.	-	-	2,0	2,5	3,0	6 ad/pcs

TopSlide 8223

102-8223

100 KG AYARLI GARDİROP SİSTEMİ 3 KAPAKLI YAVAŞLATICILI

100 KG ADJUSTABLE SLIDING WARDROBE SYSTEM 3 DOORS WITH SOFT CLOSER



Bilgi / Information

- 1 Kutu İçeriği : 2 iç kapak + 1 dış kapak + 7 ad üst yavaşlatıcı + 4 ad alt yavaşlatıcı
- 102-8223 Sürme sisteminde dış kapak çift yöne çalışmakta ve yavaşlatıcı özelliği bulunmaktadır.
- In 1 box : 2 internal doors + 1 external door + 7 pcs Top soft closers + 4 pcs bottom soft closers.
- 102-8223 In this sliding system external door running two way and the system has soft closing function.



102-8223 1 Set İçeriği / 1 Set Includes



Ray Profilleri / Rail Profiles

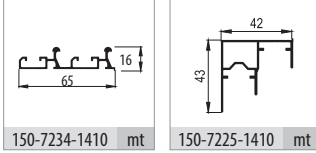

Kulp Profilleri / Handle Profiles

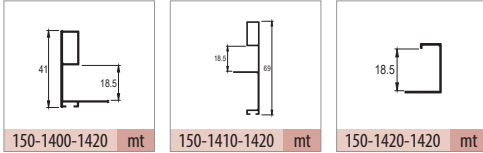

Opsiyonel Aksesuar / Optional Accessories

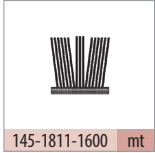

Teknik Detay / Technical Detail

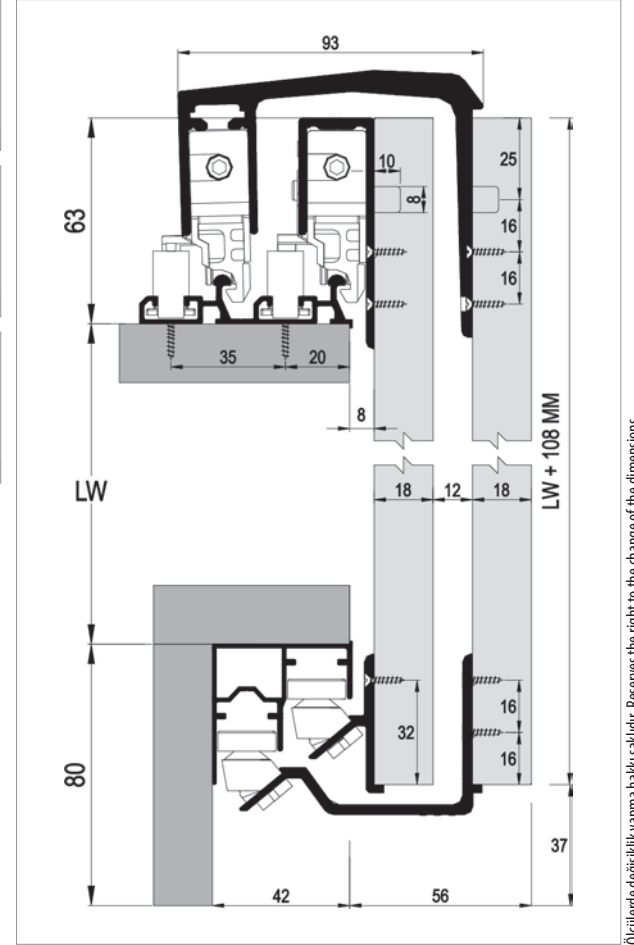

Ölçülerde değişiklik yapma hakkı saklıdır. Reserves the right to the change of the dimensions.

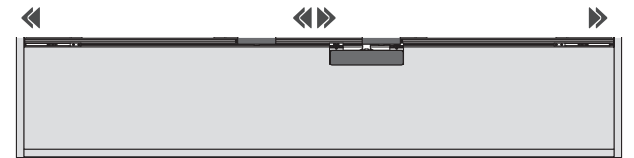

Kod / Code No	Açıklama / Description	Renk / Colour	Birim / Unit			Profil mt. / Profiles mt.			Bağ / Bnd.
102-8223-1200	Sürme Gardrop Sistemi / Sliding Wardrobe System	Silver	3 Kapak / 1 Set	5	90	-	-	-	-
145-1811-1600	Kıl Fital / Ec-Wf Hair Wick	Gri / Grey	mt.	300	7.200	-	-	-	-
150-7234-1410	Alüminyum Üst Ray Profili / Aluminium Top Rail Profile	Eloksal / Mat Anodized	mt.	-	-	2,0	2,5	3,0	6 ad/pcs
150-7225-1410	Alüminyum Alt Ray Profili / Aluminium Bottom Rail Profile	Eloksal / Mat Anodized	mt.	-	-	2,0	2,5	3,0	6 ad/pcs
150-1400-1420	Alüminyum Kulp Profili / Aluminium Handle Profile	Parlak / Bright	mt.	-	-	-	2,70	-	10 ad/pcs
150-1410-1420	Alüminyum Kulp Profili / Aluminium Handle Profile	Parlak / Bright	mt.	-	-	-	2,70	-	10 ad/pcs
150-1420-1420	Alüminyum Kapama Profili / Aluminium Closure Profile	Parlak / Bright	mt.	-	-	-	-	3,0	10 ad/pcs

TopSlide 8233

102-8233

100 KG AYARLI GARDİROP SİSTEMİ 3 KAPAKLI YAVAŞLATICILI

100 KG ADJUSTABLE SLIDING WARDROBE SYSTEM 3 DOORS WITH SOFT CLOSER



Bilgi / Information

- 1 Kutu İçeriği : 2 iç kapak + 1 dış kapak + 7 ad üst yavaşlatıcı + 4 ad alt yavaşlatıcı
- 102-8233 Sürme sisteminde dış kapak çift yöne çalışmakta ve yavaşlatıcı özelliği bulunmaktadır.
- In 1 box : 2 internal doors + 1 external door + 7 pcs Top soft closers + 4 pcs bottom soft closers.
- 102-8233 In this sliding system external door running two way and the system has soft closing function.



102-8233 1 Set İçeriği / 1 Set Includes



Ray Profilleri / Rail Profiles

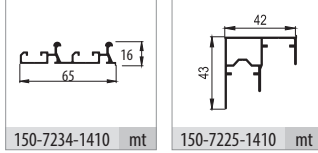

Uygulama / Application



Teknik Detay / Technical Detail

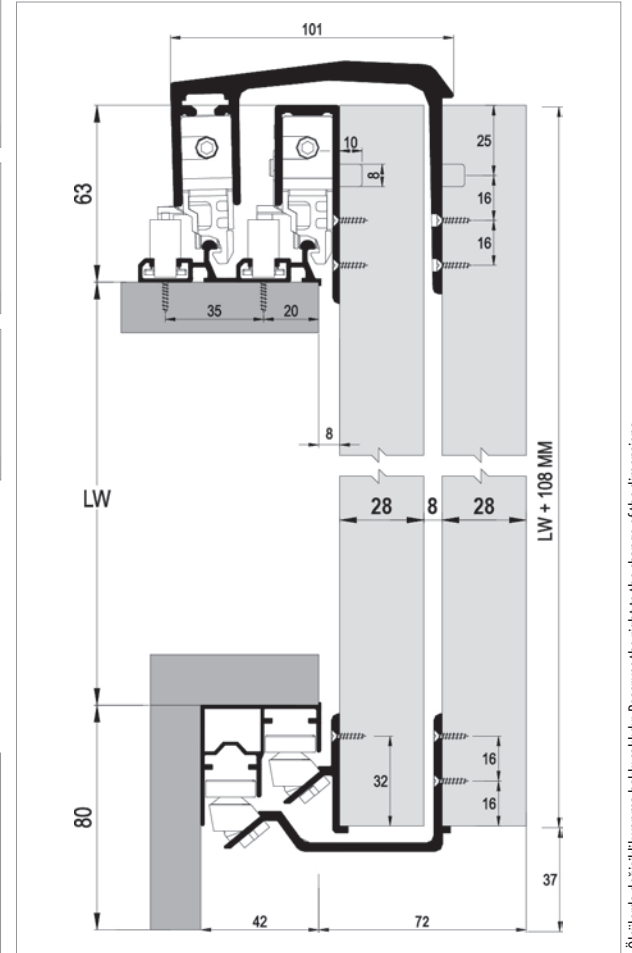

Ölçülerde değişiklik yapma hakkı saklıdır. Reserves the right to the change of the dimensions.

Kod / Code No	Açıklama / Description	Renk / Colour	Birim / Unit			Profil mt. / Profiles mt.			Bağ / Bnd.
102-8233-1200	Sürme Gardırop Sistemi / Sliding Wardrobe System	Silver	3 Kapak / 1 Set	5	90	-	-	-	-
150-7234-1410	Alüminyum Üst Ray Profili / Aluminium Top Rail Profile	Eloksal / Mat Anodized	mt.	-	-	2,0	2,5	3,0	6 ad/pcs
150-7225-1410	Alüminyum Alt Ray Profili / Aluminium Bottom Rail Profile	Eloksal / Mat Anodized	mt.	-	-	2,0	2,5	3,0	6 ad/pcs

TopSlide 8320

102-8320

100 KG AYARLI SÜRME GARDİROP SİSTEMİ
100 KG ADJUSTABLE SLIDING WARDROBE SYSTEM

Özel Üretim
Special Production

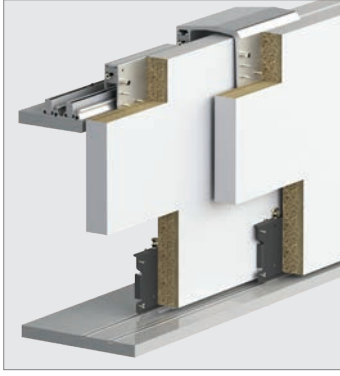

Bilgi / Information

- 1 Kutu İçeriği : 1 iç kapak + 1 dış kapak
- In 1 box : 1 internal door + 1 external door



102-8320 1 Set İçeriği / 1 Set Includes

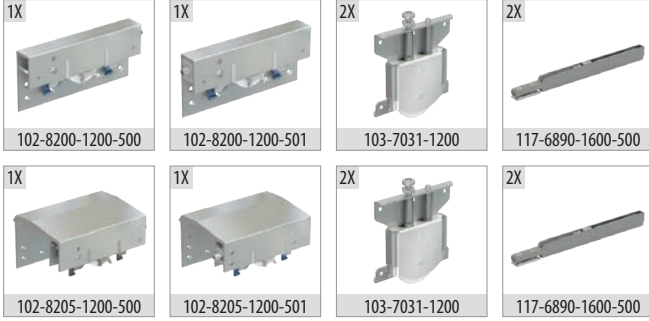

102-8323 Opsiyonel 3. İç Kapak / Optional 3. Internal Door

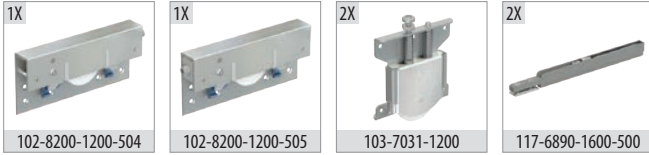

Ray Profilleri / Rail Profiles

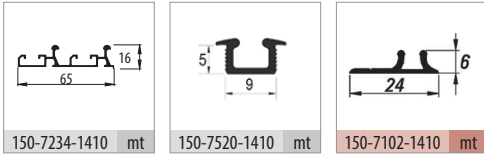

Kulp Profilleri / Handle Profiles

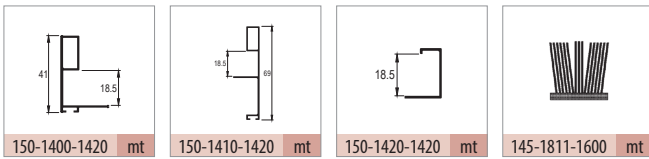

Teknik Detay / Technical Detail

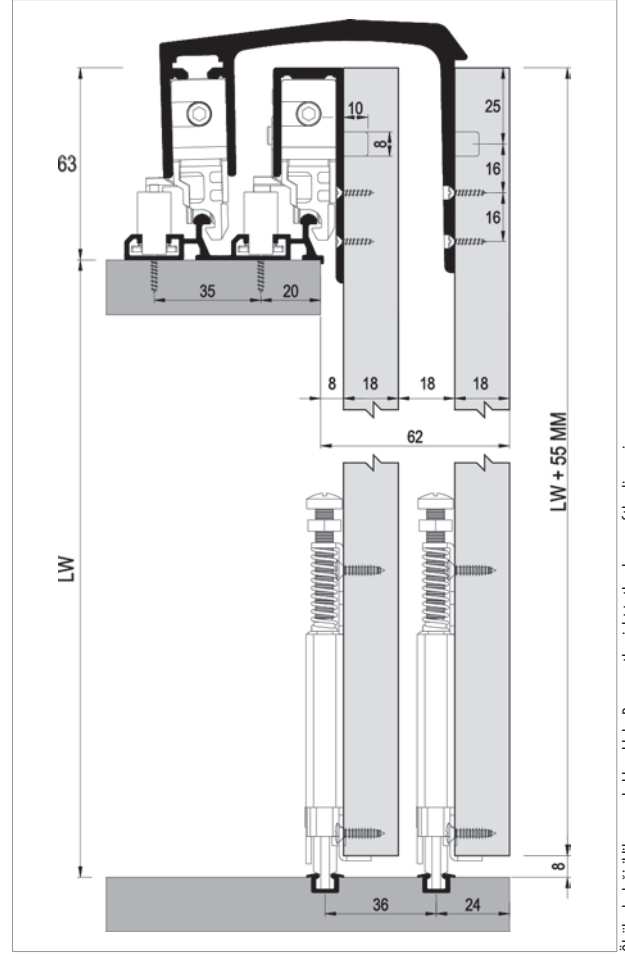

Ölçülerde değişiklik yapma hakkı saklıdır. Reserves the right to the change of the dimensions.

Kod / Code No	Açıklama / Description	Renk / Colour	Birim / Unit			Profil mt. / Profiles mt.	Bağ / Bnd.		
102-8320-1200	Sürme Gardırop Sistemi / Sliding Wardrobe System	Silver	2 Kapak / 1 Set	6	144	-	-	-	
102-8323-1200	Sürme Gardırop Sistemi 3. Kapak / Sliding Wardrobe System 3. Door	Silver	1 Kapak / 1 Kit	8	400	-	-	-	
150-7234-1410	Alüminyum Üst Ray Profili / Aluminium Top Rail Profile	Eloksal / Mat Anodized	mt.	-	-	2,0	2,5	3,0	6 ad/pcs
150-7520-1410	Alüminyum Alt Ray Profili / Aluminium Bottom Rail Profile	Eloksal / Mat Anodized	mt.	-	-	2,0	2,5	3,0	30 ad/pcs
150-7102-1410	Alüminyum Alt Ray Profili / Aluminium Bottom Rail Profile	Eloksal / Mat Anodized	mt.	-	-	-	-	3,0	20 ad/pcs
150-1400-1420	Alüminyum Kulp Profili / Aluminium Handle Profile	Parlak / Bright	mt.	-	-	-	2,70	-	10 ad/pcs
150-1410-1420	Alüminyum Kulp Profili / Aluminium Handle Profile	Parlak / Bright	mt.	-	-	-	2,70	-	10 ad/pcs
150-1420-1420	Alüminyum Kapama Profili / Aluminium Closure Profile	Parlak / Bright	mt.	-	-	-	-	3,0	10 ad/pcs

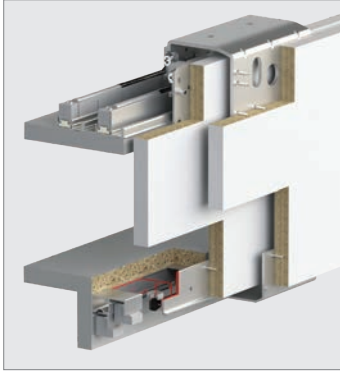

Yavaşlatıcı Alternatifi / Soft Closer Alternative

117-6820-1600 <<>> 117-6840-1600 <<>> 117-6666-1610 >>>

117-6710-1610 >>>



102-8080 İç Kapak 1 Takım İçeriği / Internal Door 1 Kit Includes



102-8084 Dış Kapak 1 Takım İçeriği / External Door 1 Kit Includes



Ray Profilleri / Rail Profiles

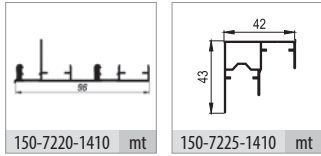

Kulp Profilleri / Handle Profiles

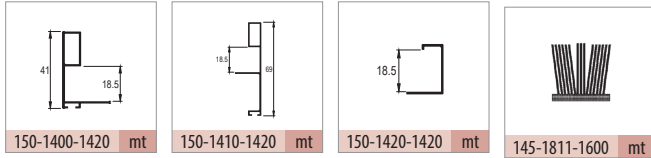

Teknik Detay / Technical Detail

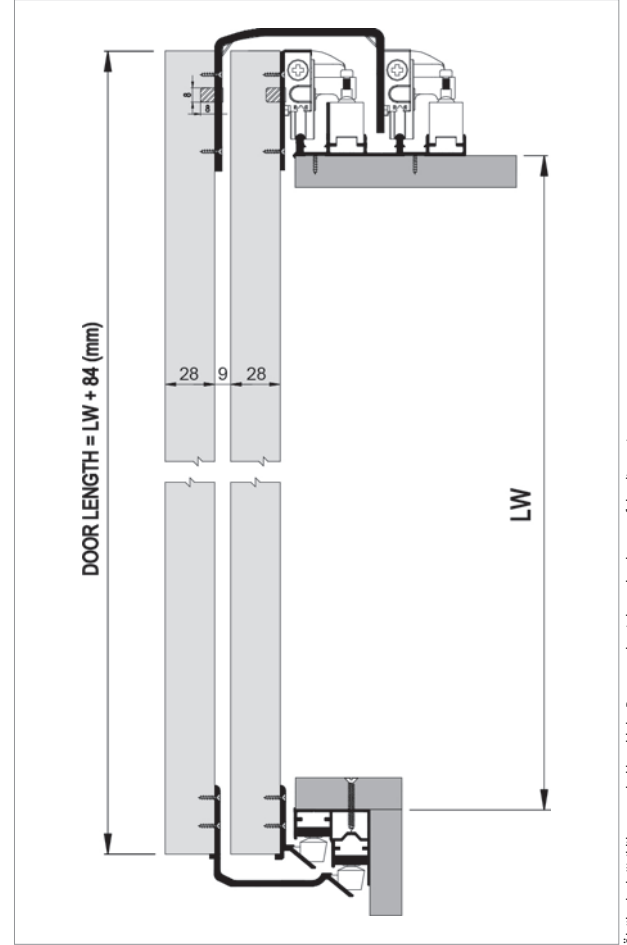

Ölçülerde değişiklik yapma hakkı saklıdır. Reserves the right to the change of the dimensions.

Kod / Code No	Açıklama / Description	Renk / Colour	Birim / Unit			Profil mt. / Profiles mt.			Bağ / Bnd.
102-8080-1200	Sürme Gardirop Sistemi İç Kapak / Sliding Wardrobe System Internal Door	Silver	1 Kapak / 1 Kit	12	384	-	-	-	-
102-8084-1200	Sürme Gardirop Sistemi Dış Kapak / Sliding Wardrobe System External Door	Silver	1 Kapak / 1 Kit	12	216	-	-	-	-
117-6820-1600	80 kg Yavaşlatıcı Mekanizma / 80 kg Soft Closer Mechanism	Gri / Grey	1 Kapak / 1 Kit	24	576	-	-	-	-
150-7220-1410	Alüminyum Üst Ray Profili / Aluminium Top Rail Profile	Eloksal / Mat Anodized	mt.	-	-	2,0	2,5	3,0	6 ad/pcs
150-7225-1410	Alüminyum Alt Ray Profili / Aluminium Bottom Rail Profile	Eloksal / Mat Anodized	mt.	-	-	2,0	2,5	3,0	6 ad/pcs
150-1400-1420	Alüminyum Kulp Profili / Aluminium Handle Profile	Parlak / Bright	mt.	-	-	-	2,70	-	10 ad/pcs
150-1410-1420	Alüminyum Kulp Profili / Aluminium Handle Profile	Parlak / Bright	mt.	-	-	-	2,70	-	10 ad/pcs
150-1420-1420	Alüminyum Kapama Profili / Aluminium Closure Profile	Parlak / Bright	mt.	-	-	-	-	3,0	10 ad/pcs
145-1811-1600	Kıl Fital / Ec-Wf Hair Wick	Gri / Grey	mt.	300	7.200	-	-	-	-

TopSlide 8040

102-8040

70 KG AYARLI SÜRME GARDİROP SİSTEMİ
70 KG ADJUSTABLE SLIDING WARDROBE SYSTEM

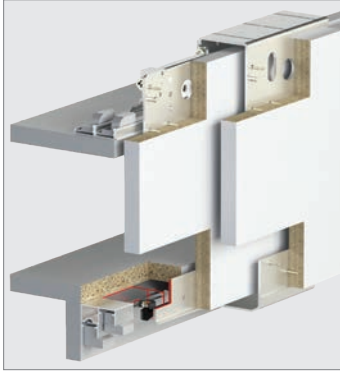

■ Yavaşlatıcı Alternatifi / Soft Closer Alternative

117-6666-1610 ►► 117-6710-1610 ►►



■ 102-8040 İç Kapak 1 Takım İçeriği / Internal Door 1 Kit Includes

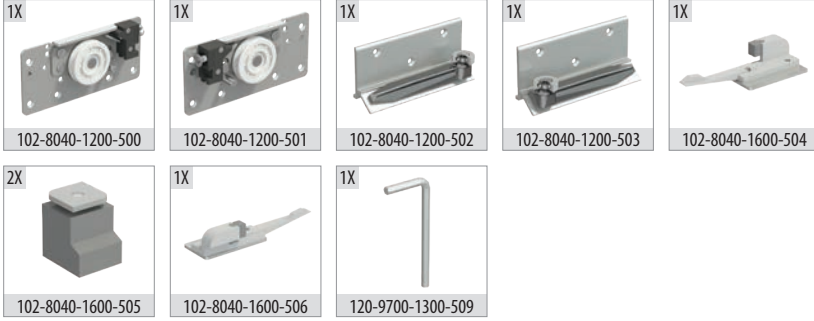

■ 102-8042 Dış Kapak 1 Takım İçeriği / External Door 1 Kit Includes

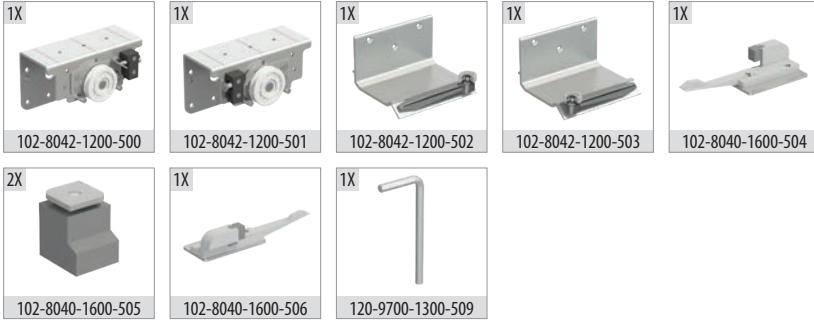

■ Ray Profilleri / Rail Profiles

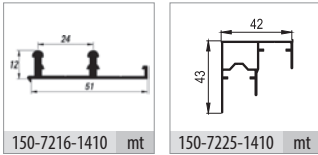

■ Kulp Profilleri / Handle Profiles

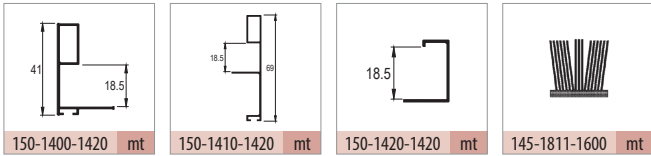

■ Teknik Detay / Technical Detail

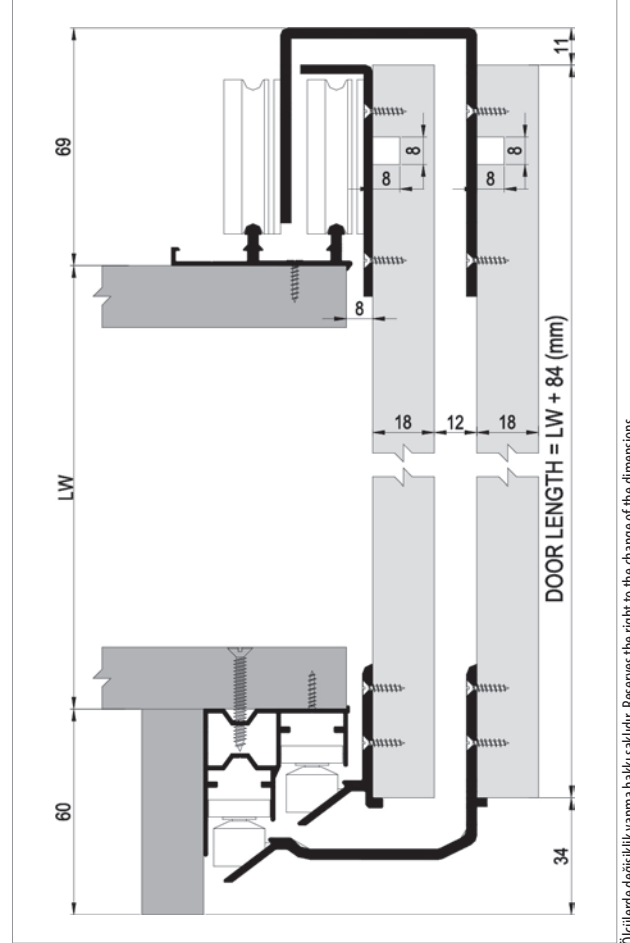

Ölçülerde değişiklik yapma hakkı saklıdır. Reserves the right to the change of the dimensions.

Kod / Code No	Açıklama / Description	Renk / Colour	Birim / Unit			Profil mt. / Profiles mt.			Bağ / Bnd.
102-8040-1200	Sürme Gardırop Sistemi İç Kapak / Sliding Wardrobe System Internal Door	Silver	1 Kapak / 1 Kit	16	384	-	-	-	-
102-8042-1200	Sürme Gardırop Sistemi Dış Kapak / Sliding Wardrobe System External Door	Silver	1 Kapak / 1 Kit	12	288	-	-	-	-
150-7216-1410	Alüminyum Üst Ray Profili / Aluminium Top Rail Profile	Eloksal / Mat Anodized	mt.	-	-	2,0	2,5	3,0	6 ad/pcs
150-7225-1410	Alüminyum Alt Ray Profili / Aluminium Bottom Rail Profile	Eloksal / Mat Anodized	mt.	-	-	2,0	2,5	3,0	6 ad/pcs
150-1400-1420	Alüminyum Kulp Profili / Aluminium Handle Profile	Parlak / Bright	mt.	-	-	-	2,70	-	10 ad/pcs
150-1410-1420	Alüminyum Kulp Profili / Aluminium Handle Profile	Parlak / Bright	mt.	-	-	-	2,70	-	10 ad/pcs
150-1420-1420	Alüminyum Kapama Profili / Aluminium Closure Profile	Parlak / Bright	mt.	-	-	-	-	3,0	10 ad/pcs
145-1811-1600	Kıl Fital / Ec-Wf Hair Wick	Gri / Grey	mt.	300	7.200	-	-	-	-

TopSlide 8010

102-8010

60 KG AYARLI SÜRME GARDİROP SİSTEMİ
60 KG ADJUSTABLE SLIDING WARDROBE SYSTEM

Özel Üretim
Special Production

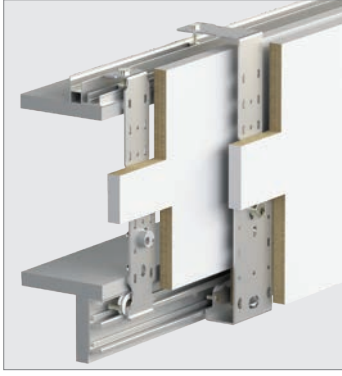

Yavaşlatıcı Alternatifi / Soft Closer Alternative

117-6666-1610 ►► 117-6710-1610 ►►



102-8010 İç Kapak 1 Takım İçeriği / Internal Door 1 Kit Includes

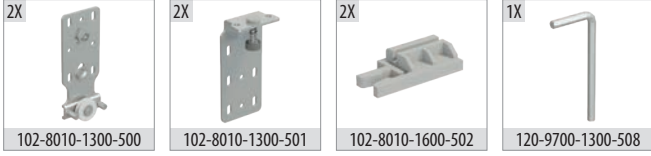

102-8012 Dış Kapak 1 Takım İçeriği / External Door 1 Kit Includes

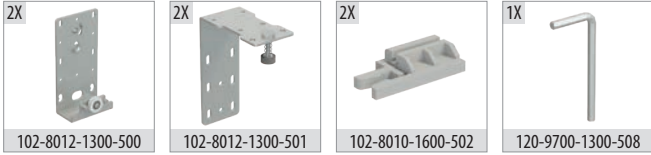

Ray Profilleri / Rail Profiles

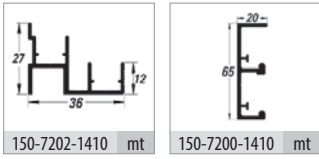

Kulp Profilleri / Handle Profiles

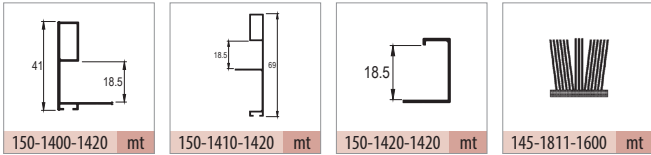

Teknik Detay / Technical Detail

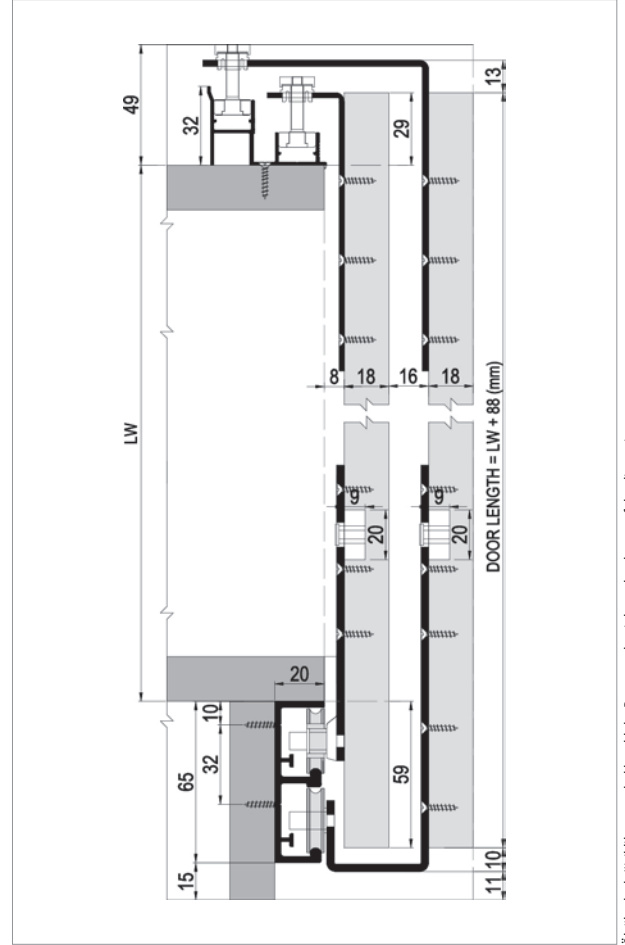

Ölçülerde değişiklik yapma hakkı saklıdır. Reserves the right to the change of the dimensions.

Kod / Code No	Açıklama / Description	Renk / Colour	Birim / Unit			Profil mt. / Profiles mt.	Bağ / Bnd.
102-8010-1300	Sürme Gardırop Sistemi İç Kapak / Sliding Wardrobe System Internal Door	Galvaniz / Galvanized	1 Kapak / 1 Kit	24	576	-	-
102-8012-1300	Sürme Gardırop Sistemi Dış Kapak / Sliding Wardrobe System External Door	Galvaniz / Galvanized	1 Kapak / 1 Kit	8	256	-	-
150-7202-1410	Alüminyum Üst Ray Profili / Aluminium Top Rail Profile	Eloksal / Mat Anodized	mt.	-	-	-	3,0 6 ad/pcs
150-7200-1410	Alüminyum Alt Ray Profili / Aluminium Bottom Rail Profile	Eloksal / Mat Anodized	mt.	-	-	-	3,0 6 ad/pcs
150-1400-1420	Alüminyum Kulp Profili / Aluminium Handle Profile	Parlak / Bright	mt.	-	-	2,70	- 10 ad/pcs
150-1410-1420	Alüminyum Kulp Profili / Aluminium Handle Profile	Parlak / Bright	mt.	-	-	2,70	- 10 ad/pcs
150-1420-1420	Alüminyum Kapama Profili / Aluminium Closure Profile	Parlak / Bright	mt.	-	-	-	3,0 10 ad/pcs
145-1811-1600	Kıl Fital / Ec-Wf Hair Wick	Gri / Grey	mt.	300	7.200	-	-

TopSlide 7320

102-7320

60 KG AYARLI SÜRME GARDİROP SİSTEMİ
60 KG ADJUSTABLE SLIDING WARDROBE SYSTEM

Özel Üretim
Special Production

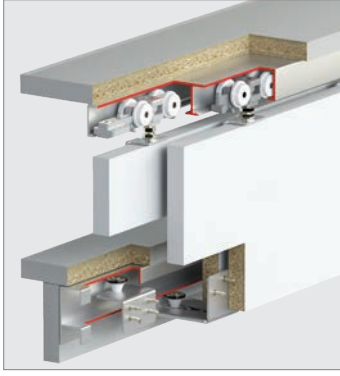

Yavaşlatıcı Alternatifi / Soft Closer Alternative

117-6666-1610 ►► 117-6710-1610 ►►



102-7320 İç Kapak 1 Takım İçeriği / Internal Door 1 Kit Includes

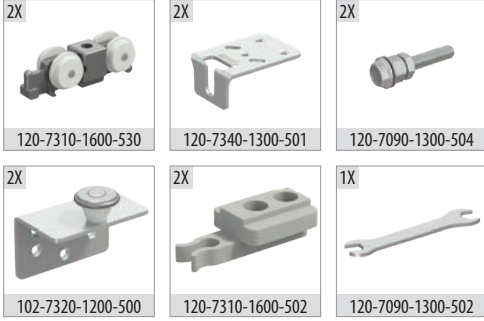

102-7322 Dış Kapak 1 Takım İçeriği / External Door 1 Kit Includes

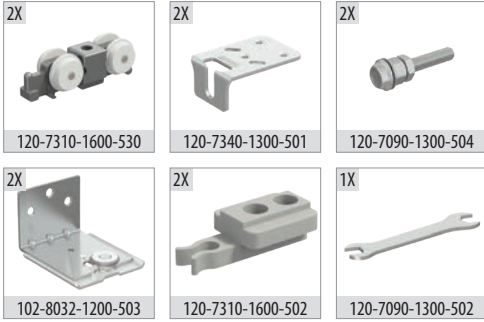

Ray Profilleri / Rail Profiles

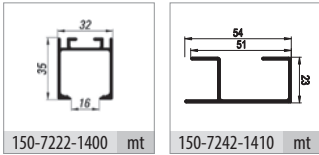

Kulp Profilleri / Handle Profiles

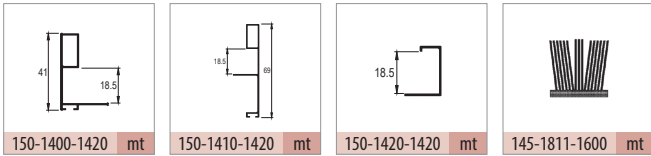

Teknik Detay / Technical Detail

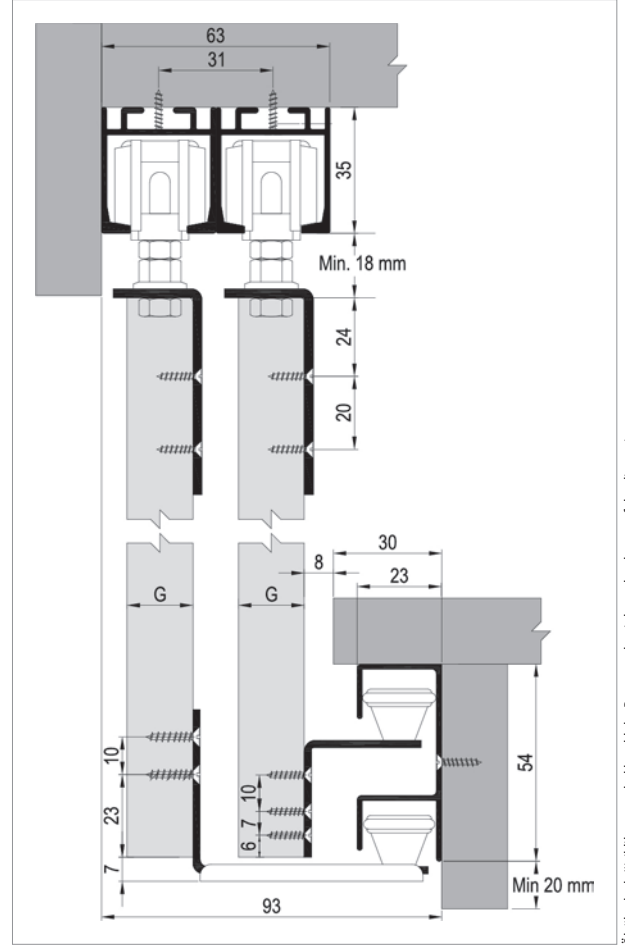

Ölçülerde değişiklik yapma hakkı saklıdır. Reserves the right to the change of the dimensions.

Kod / Code No	Açıklama / Description	Renk / Colour	Birim / Unit			Profil mt. / Profiles mt.	Bağ / Bnd.
102-7320-1600	Sürme Gardırop Sistemi İç Kapak / Sliding Wardrobe System Internal Door	Galvaniz / Galvanized	1 Kapak / 1 Kit	24	768	- - -	-
102-7322-1600	Sürme Gardırop Sistemi Dış Kapak / Sliding Wardrobe System External Door	Galvaniz / Galvanized	1 Kapak / 1 Kit	24	768	- - -	-
150-7222-1400	Alüminyum Üst Ray Profili / Aluminium Top Rail Profile	Pres / Uncoated	mt.	-	-	2,0 - 3,0	6 ad/pcs
150-7242-1410	Alüminyum Alt Ray Profili / Aluminium Bottom Rail Profile	Eloksal / Mat Anodized	mt.	-	-	2,0 - 3,0	6 ad/pcs
150-1400-1420	Alüminyum Kulp Profili / Aluminium Handle Profile	Parlak / Bright	mt.	-	-	- 2,70 -	10 ad/pcs
150-1410-1420	Alüminyum Kulp Profili / Aluminium Handle Profile	Parlak / Bright	mt.	-	-	- 2,70 -	10 ad/pcs
150-1420-1420	Alüminyum Kapama Profili / Aluminium Closure Profile	Parlak / Bright	mt.	-	-	- - 3,0	10 ad/pcs
145-1811-1600	Kıl Fital / Ec-Wf Hair Wick	Gri / Grey	mt.	300	7.200	- - -	-

TopSlide 8030

102-8030

60 KG AYARLI SÜRME GARDİROP SİSTEMİ
60 KG ADJUSTABLE SLIDING WARDROBE SYSTEM



■ Yavaşlatıcı Alternatifi / Soft Closer Alternative

117-6711-1610 ►►



■ 102-8030 İç Kapak 1 Takım İçeriği / Internal Door 1 Kit Includes



■ 102-8032 Dış Kapak 1 Takım İçeriği / External Door 1 Kit Includes

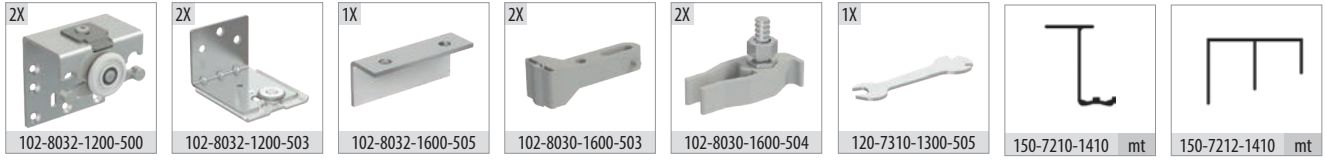

■ Ray Profilleri / Rail Profiles

■ 117-6711 Yavaşlatıcı Bağlantı Kiti / Soft Closing Connection Kit

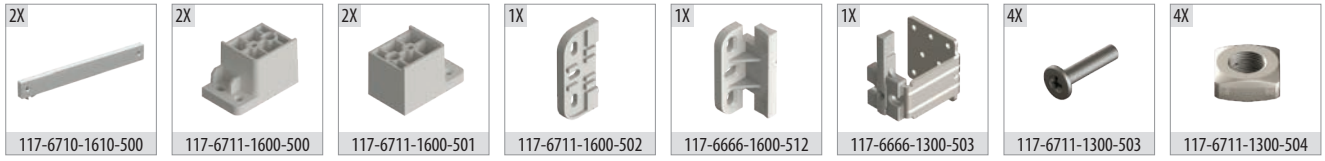

■ Teknik Detay / Technical Detail

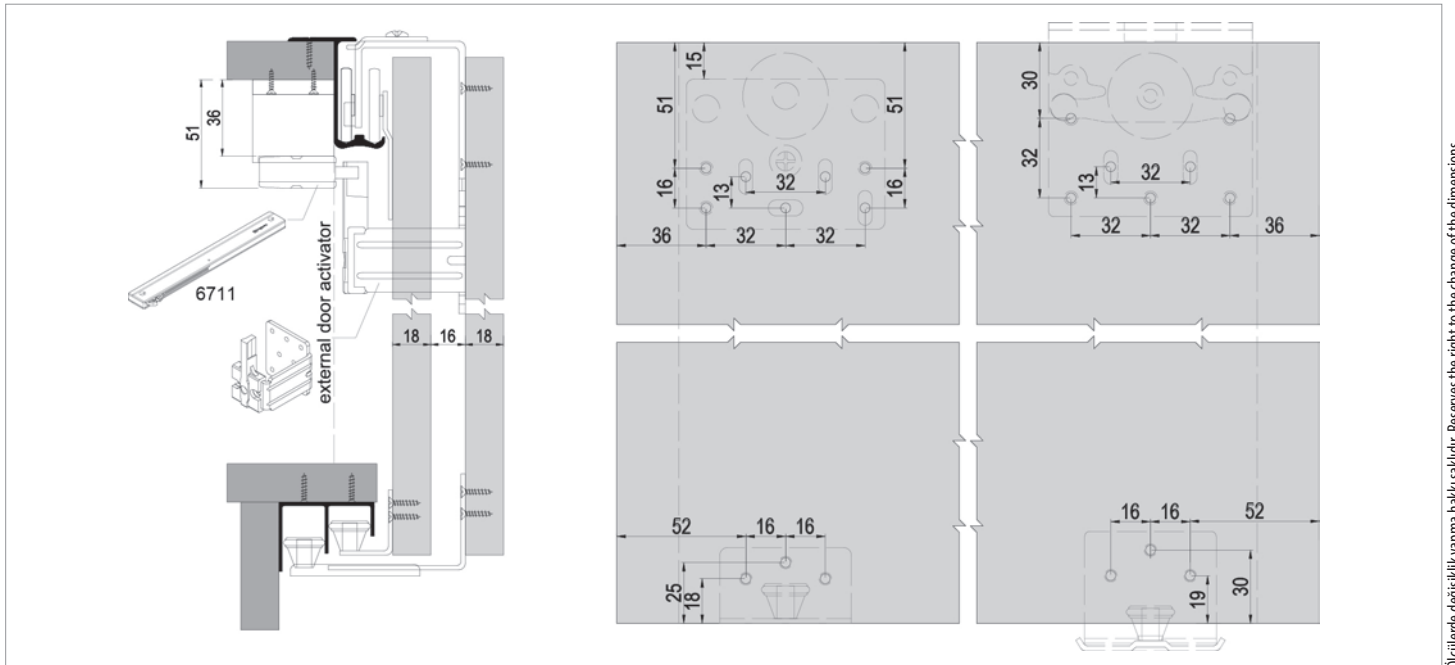

Ölçülerde değişiklik yapma hakkı saklıdır. Reserves the right to the change of the dimensions.

Kod / Code No	Açıklama / Description	Renk / Colour	Birim / Unit			Profil mt. / Profiles mt.	Bağ / Bnd.
102-8030-1300	Sürme Gardirop Sistemi İç Kapak / Sliding Wardrobe System Internal Door	Silver	1 Kapak / 1 Kit	24	768	-	-
102-8032-1200	Sürme Gardirop Sistemi Dış Kapak / Sliding Wardrobe System External Door	Silver	1 Kapak / 1 Kit	24	384	-	-
117-6711-1610	100 Kg Yavaşlatıcı Sistem / 100 Kg Soft Closers	Gri / Grey	1 Takım / 1 Kit	20	480	-	-
150-7210-1410	Alüminyum Üst Ray Profili / Aluminium Top Rail Profile	Eloksal / Mat Anodized	mt.	-	-	-	3,0
150-7212-1410	Alüminyum Alt Ray Profili / Aluminium Bottom Rail Profile	Eloksal / Mat Anodized	mt.	-	-	-	3,0

TopSlide 8400

102-8400

60 KG AYARLI SÜRME GARDIROP SİSTEMİ
60 KG ADJUSTABLE SLIDING WARDROBE SYSTEM

Yeni Ürün
New Product

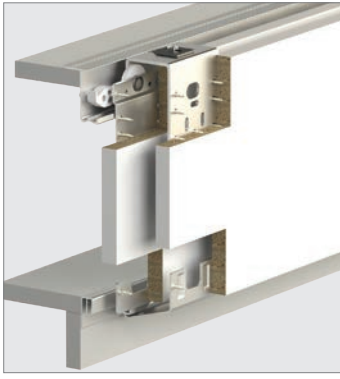

Yavaşlatıcı Alternatifi / Soft Closer Alternative

117-6711-1610 >>



102-8400 İç Kapak 1 Takım İçeriği / Internal Door 1 Kit Includes

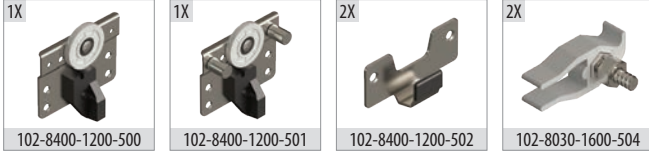

102-8402 Dış Kapak 1 Takım İçeriği / External Door 1 Kit Includes

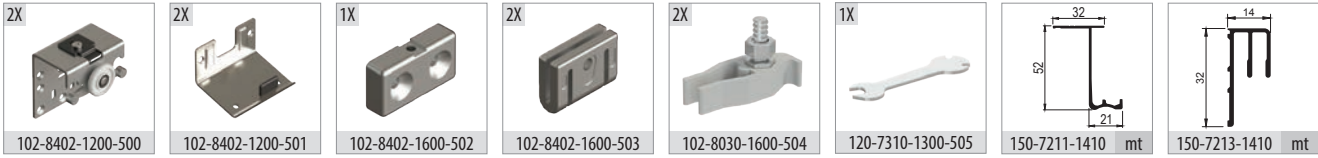

117-6711 Yavaşlatıcı Bağlantı Kiti / Soft Closing Connection Kit

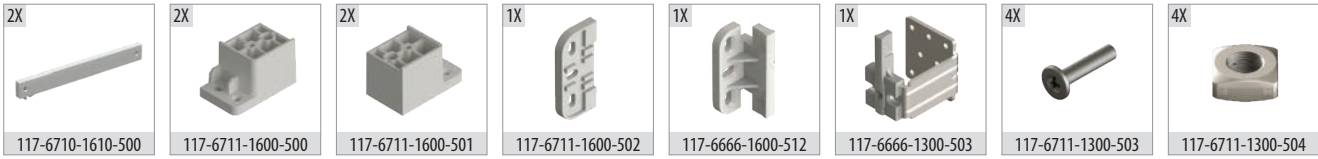

Teknik Detay / Technical Detail

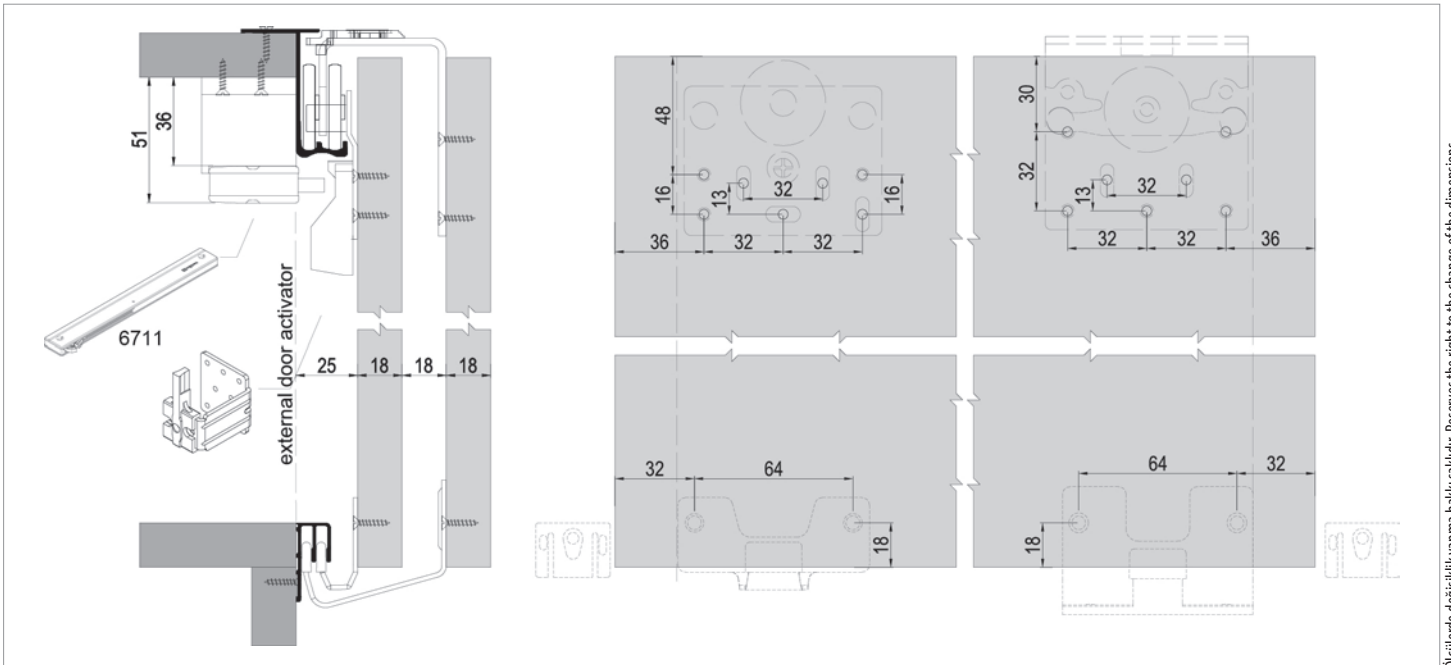

Ölçülerde değişiklik yapma hakkı saklıdır. Reserves the right to the change of the dimensions.

Kod / Code No	Açıklama / Description	Renk / Colour	Birim / Unit			Profil mt. / Profiles mt.	Bağ / Bnd.
102-8400-1300	Sürme Gardirop Sistemi İç Kapak / Sliding Wardrobe System Internal Door	Silver	1 Kapak / 1 Kit	24	768	- - -	-
102-8402-1200	Sürme Gardirop Sistemi Dış Kapak / Sliding Wardrobe System External Door	Silver	1 Kapak / 1 Kit	12	384	- - -	-
117-6711-1610	100 Kg Yavaşlatıcı Sistem / 100 Kg Soft Closers	Gri / Grey	1 Takım / 1 Kit	20	480	- - -	-
150-7211-1410	Alüminyum Üst Ray Profili / Aluminium Top Rail Profile	Eloksal / Mat Anodized	mt.	-	-	- - 3,0	6 ad/pcs
150-7213-1410	Alüminyum Alt Ray Profili / Aluminium Bottom Rail Profile	Eloksal / Mat Anodized	mt.	-	-	- - 3,0	6 ad/pcs

TopSlide 0190

102-0190

70 KG AYARLI SÜRME GARDİROP SİSTEMİ
70 KG ADJUSTABLE SLIDING WARDROBE SYSTEM

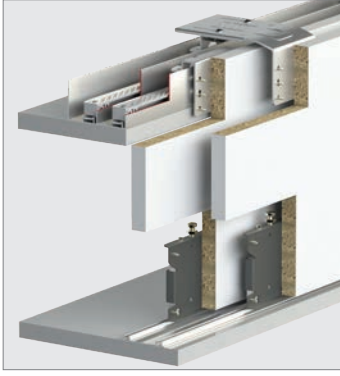

Bilgi / Information

- 1 Kutu İçeriği : 1 iç kapak + 1 dış kapak + 4 ad yavaşlatıcı
- In 1 box : 1 internal door + 1 external door + 4 pcs soft closers



102-0190 1 Set İçeriği / 1 Set Includes

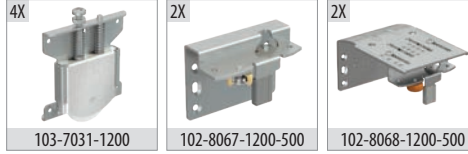

102-0193 Opsiyonel 3. İç Kapak / Optional 3. Internal Door

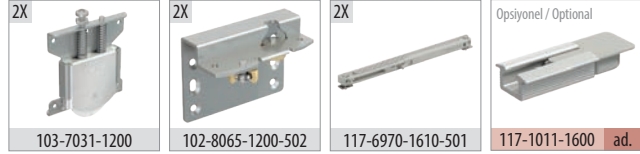

Ray Profilleri / Rail Profiles

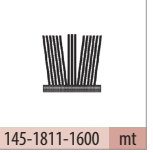
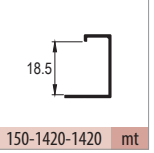
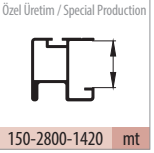
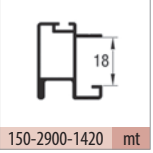
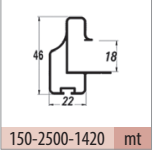
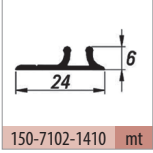
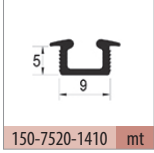
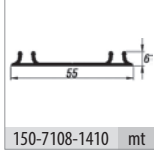
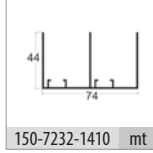

Teknik Detay / Technical Detail

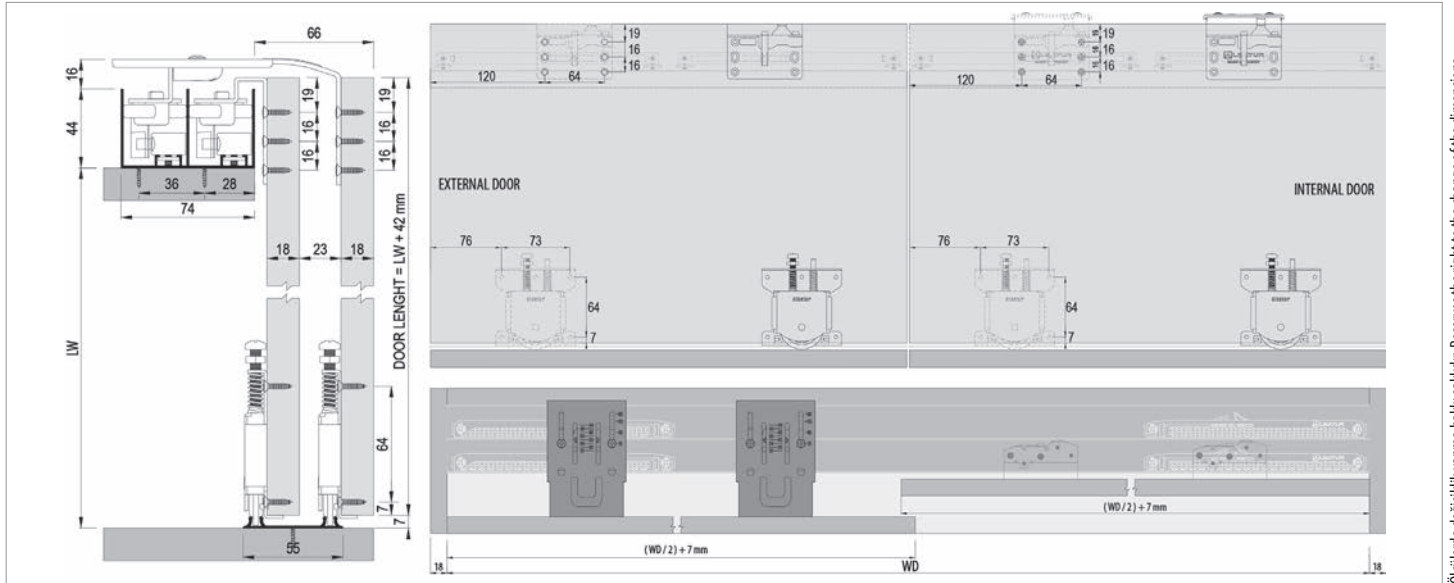

Kod / Code No	Açıklama / Description	Renk / Colour	Birim / Unit			Profil mt. / Profiles mt.	Bağ / Bnd.
102-0190-1200	SRG 190 - Sürme Gardirop Sistemi / SRG 190 - Sliding Wardrobe System	Silver	2 Kapak / 1 Set	12	216	- - -	-
102-0193-1200	SRG 190 C - Sürme Gardirop Sistemi 3. Kapak / Sliding Wardrobe System 3. Door	Silver	1 Kapak / 1 Kit	12	360	- - -	-
145-1811-1600	Kil Fital / Ec-Wf Hair Wick	Gri / Grey	mt.	300	7.200	- - -	-
150-7232-1410	Alüminyum Üst Ray Profili / Aluminium Top Rail Profile	Eloksal / Mat Anodized	mt.	-	-	2,0 2,5 3,0	6 ad/pcs
150-7108-1410	Alüminyum Alt Ray Profili / Aluminium Bottom Rail Profile	Eloksal / Mat Anodized	mt.	-	-	2,0 2,5 3,0	12 ad/pcs
150-7520-1410	Alüminyum Alt Ray Profili / Aluminium Bottom Rail Profile	Eloksal / Mat Anodized	mt.	-	-	- - 3,0	30 ad/pcs
150-7102-1410	Alüminyum Alt Ray Profili / Aluminium Bottom Rail Profile	Eloksal / Mat Anodized	mt.	-	-	- - 3,0	20 ad/pcs
150-2500-1420	Alüminyum Kulp Profili / Aluminium Handle Profile	Parlak / Bright	mt.	-	-	2,0 - 3,0	6 ad/pcs
150-2900-1420	Alüminyum Kulp Profili / Aluminium Handle Profile	Parlak / Bright	mt.	-	-	2,0 2,5 3,0	6 ad/pcs
150-2800-1420	Alüminyum Kulp Profili / Aluminium Handle Profile	Parlak / Bright	mt.	-	-	- - 3,0	6 ad/pcs
150-1420-1420	Alüminyum Kapama Profili / Aluminium Closure Profile	Parlak / Bright	mt.	-	-	- - 3,0	10 ad/pcs

TopSlide 0195

102-0195

50 KG AYARLI SÜRME GARDIROP SİSTEMİ
50 KG ADJUSTABLE SLIDING WARDROBE SYSTEM

Özel Üretim
Special Production

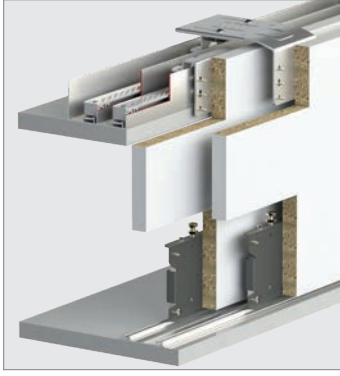

Bilgi / Information

- 1 Kutu İçeriği : 1 iç kapak + 1 dış kapak + 4 ad yavaşlatıcı
- In 1 box : 1 internal door + 1 external door + 4 pcs soft closers



102-0195 1 Set İçeriği / 1 Set Includes

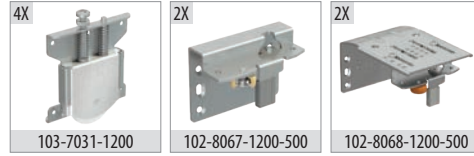

102-0196 Opsiyonel 3. İç Kapak / Optional 3. Internal Door

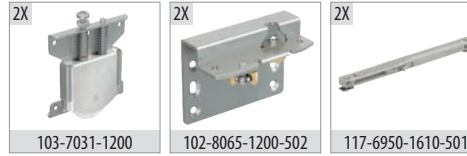

Ray Profilleri / Rail Profiles

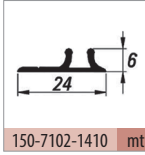
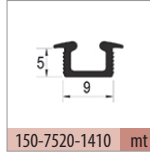
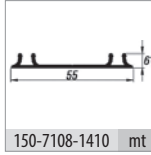
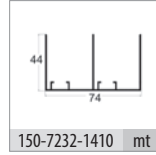

Kulp Profilleri / Handle Profiles

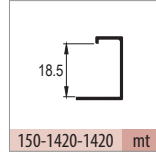
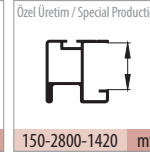
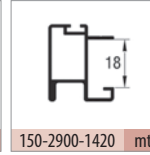
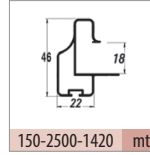

Teknik Detay / Technical Detail

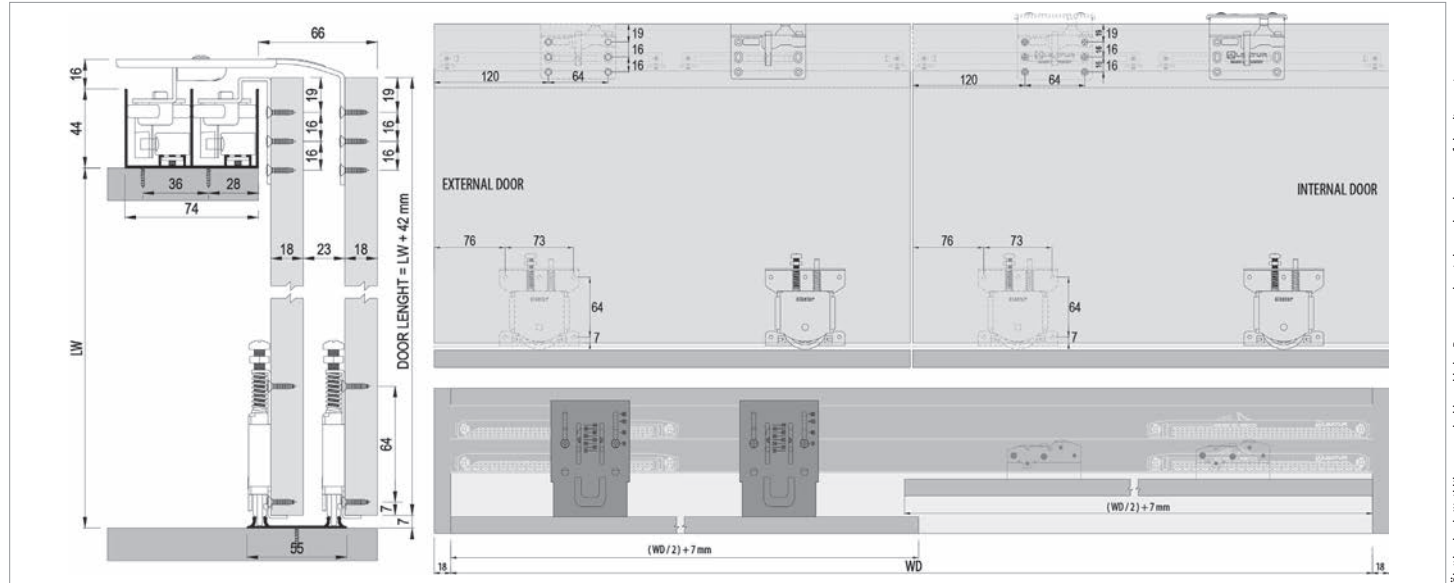

Kod / Code No	Açıklama / Description	Renk / Colour	Birim / Unit			Profil mt. / Profiles mt.			Bağ / Bnd.
102-0195-1200	SRG 195 - Sürme Gardirop Sistemi / SRG 195 - Sliding Wardrobe System	Silver	2 Kapak / 1 Set	12	216	-	-	-	-
102-0196-1200	SRG 195 C - Sürme Gardirop Sistemi 3. Kapak / Sliding Wardrobe System 3. Door	Silver	1 Kapak / 1 Kit	12	360	-	-	-	-
145-1811-1600	Kil Fital / Ec-Wf Hair Wick	Gri / Grey	mt.	300	7.200	-	-	-	-
150-7232-1410	Alüminyum Üst Ray Profili / Aluminium Top Rail Profile	Eloksal / Mat Anodized	mt.	-	-	2,0	2,5	3,0	6 ad/pcs
150-7108-1410	Alüminyum Alt Ray Profili / Aluminium Bottom Rail Profile	Eloksal / Mat Anodized	mt.	-	-	2,0	2,5	3,0	12 ad/pcs
150-7520-1410	Alüminyum Alt Ray Profili / Aluminium Bottom Rail Profile	Eloksal / Mat Anodized	mt.	-	-	-	-	3,0	30 ad/pcs
150-7102-1410	Alüminyum Alt Ray Profili / Aluminium Bottom Rail Profile	Eloksal / Mat Anodized	mt.	-	-	-	-	3,0	20 ad/pcs
150-2500-1420	Alüminyum Kulp Profili / Aluminium Handle Profile	Parlak / Bright	mt.	-	-	2,0	-	3,0	6 ad/pcs
150-2900-1420	Alüminyum Kulp Profili / Aluminium Handle Profile	Parlak / Bright	mt.	-	-	2,0	2,5	3,0	6 ad/pcs
150-2800-1420	Alüminyum Kulp Profili / Aluminium Handle Profile	Parlak / Bright	mt.	-	-	-	-	3,0	6 ad/pcs
150-1420-1420	Alüminyum Kapama Profili / Aluminium Closure Profile	Parlak / Bright	mt.	-	-	-	-	3,0	10 ad/pcs

TopSlide 0200

102-0200

50 KG AYARLI SÜRME GARDIROP SİSTEMİ
50 KG ADJUSTABLE SLIDING WARDROBE SYSTEM

Yeni Ürün
New Product

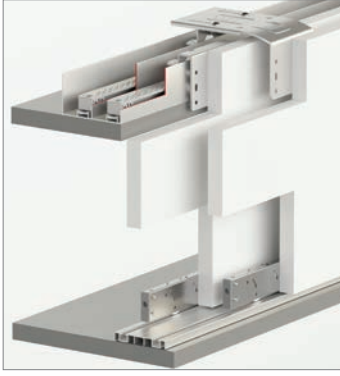

Bilgi / Information

- 1 Kutu İçeriği : 1 iç kapak + 1 dış kapak + 4 ad yavaşlatıcı
- In 1 box : 1 internal door + 1 external door + 4 pcs soft closers



102-0200 1 Set İçeriği / 1 Set Includes

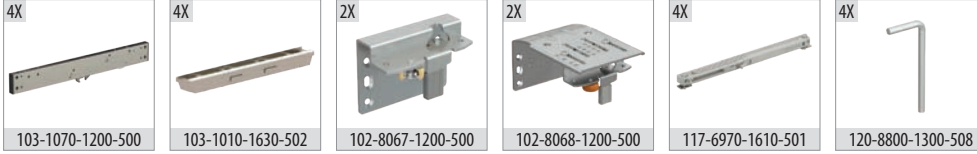

Ray Profilleri / Rail Profiles

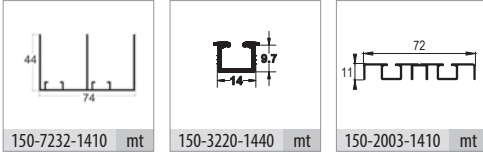

Kulp Profilleri / Handle Profiles

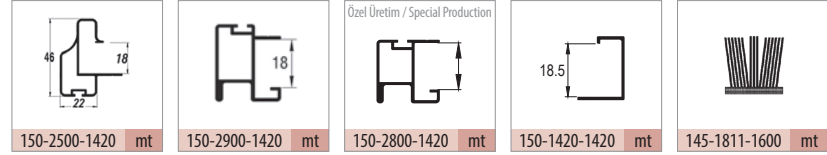

Teknik Detay / Technical Detail

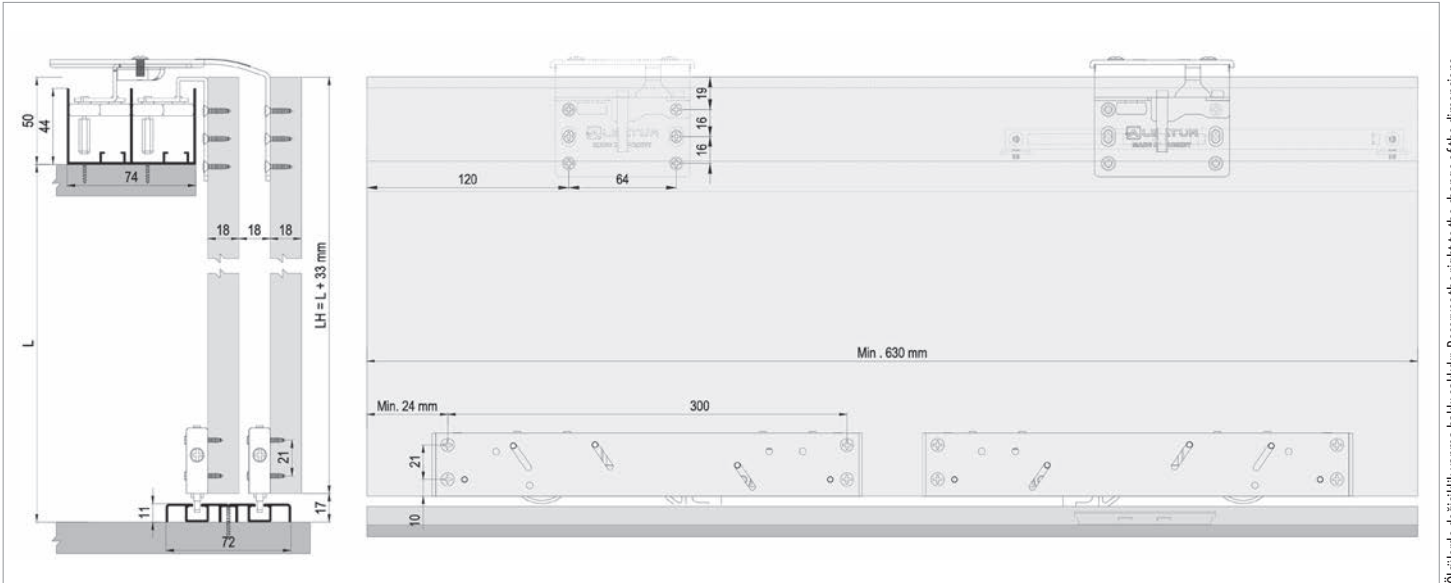



Ölçülerde değişiklik yapma hakkı saklıdır. Reserves the right to the change of the dimensions.

Kod / Code No	Açıklama / Description	Renk / Colour	Birim / Unit			Profil mt. / Profiles mt.			Bağ / Bnd.
102-0200-1200	SRG 190 - Sürme Gardirop Sistemi / SRG 190 - Sliding Wardrobe System	Silver	2 Kapak / 1 Set	12	216	-	-	-	-
145-1811-1600	Kil Fital / Ec-Wf Hair Wick	Gri / Grey	mt.	300	7.200	-	-	-	-
150-7232-1410	Alüminyum Üst Ray Profili / Aluminium Top Rail Profile	Eloksal / Mat Anodized	mt.	-	-	2,0	2,5	3,0	6 ad/pcs
150-2003-1410	Alüminyum Alt Ray Profili / Aluminium Bottom Rail Profile	Eloksal / Mat Anodized	mt.	-	-	2,0	2,5	3,0	12 ad/pcs
150-3220-1410	Alüminyum Alt Ray Profili / Aluminium Bottom Rail Profile	Eloksal / Mat Anodized	mt.	-	-	-	-	3,0	20 ad/pcs
150-2500-1420	Alüminyum Kulp Profili / Aluminium Handle Profile	Parlak / Bright	mt.	-	-	2,0	-	3,0	6 ad/pcs
150-2900-1420	Alüminyum Kulp Profili / Aluminium Handle Profile	Parlak / Bright	mt.	-	-	2,0	2,5	3,0	6 ad/pcs
150-2800-1420	Alüminyum Kulp Profili / Aluminium Handle Profile	Parlak / Bright	mt.	-	-	-	-	3,0	6 ad/pcs
150-1420-1420	Alüminyum Kapama Profili / Aluminium Closure Profile	Parlak / Bright	mt.	-	-	-	-	3,0	10 ad/pcs



TopSlide 0200

<p>SINCE 1976</p>	 <p>Bearing Systems</p>	<p>EN 1527 100.000 CYCLES TEST</p> 	<p>R</p> <p>The Sliding System</p>
-----------------------	--	--	---



Group 103

Multiline[®]

Sürme Kapak Serisi

Sliding Door Series





Bu serideki tüm ürünleri incelemek için QR kodu okutabilirsiniz.

You can analyze the QR code to see all the products in these series.



Multiline SRG 100

<p>SINCE 1976</p>	 <p>Bearing Systems</p>	<p>EN 1527 100.000 CYCLES TEST</p> 	<p>R</p> <p>The Sliding System</p>
-----------------------	--	--	---



	OEM Kod OEM Code	Ürün Kodu Product Code	Sistem Tipi System Type	Panel Tipi Panel Type	Fren Yönü Brake Direc.	Panel mm	Taşıma Kg Capacity Kg	Video	Üst Ray Upper Rail	Alt Ray Lower Rail	Kapak Adeti Number of Doors	Yavaşlatıcı Dahil Soft Closer Including	Min. Kapak Genişlik mm Min. Cover Width mm
1	103-1010	Multiline 1				16 - 22	50	✓	150-3225	150-3230	2	✓	680 mm
2	103-1020	Multiline 2				16 - 22	50	✓	150-3225	150-3230	2	✓	680 mm
3	103-1030	Multiline 3				16 - 22	40		150-3225	150-3230	2	✓	400 mm
4	103-1040	Multiline 4				16 - 30	50	✓	150-3250	150-3250	2	✓	-
5	103-1050	Multiline 5				18 - 25	20	✓	150-7633	-	2	✓	-
6	103-1070	Multiline 7				18 - 30	50	✓	150-3220	150-3220	2	✓	630 mm
7	103-1080	Multiline 8				16 - 30	50	✓	150-3250	150-3250	2	✓	-
8	103-1090	Multiline 9				18 - 30	45	✓	150-7094	-	2	✓	350 mm
9	103-1100	Multiline 10				16 - 22	50	✓	150-3250	150-3250	2	✓	400 mm
10	103-1110	Multiline 11				16 - 22	50	✓	150-3250	150-3250	2	✓	450 mm
11	103-1120	Multiline 12				16 - 22	50	✓	150-3255	150-7108	2	✓	400 mm
12	103-1130	Multiline 13				16 - 22	50	✓	150-3255	150-7108	2	✓	450 mm
13	103-1140	Multiline 14				16 - 30	15	✓	150-3290	150-3290	2	✓	-
14	103-1150	Multiline 15				18 - 22	50	✓	150-2910	150-7108	2	✓	-
15	103-1160	Multiline 16				16 - 22	50	✓	150-3255	150-7108	2	✓	400 mm
16	103-1170	Multiline 17				16 - 22	50	✓	150-3255	150-7108	2	✓	450 mm
17	103-1180	Multiline 18				18 - 30	50	✓	150-3220	150-7108	2	✓	630 mm
18	103-0100	Multiline SRG 100				18 - 22	60	✓	150-2910	150-7108	2	✓	-
19	103-0300	Multiline SRG 300				18 - 22	70	✓	150-2910	150-7108	2	✓	-
20	103-0110	Multiline SRG 110				18 - 20	70	✓	150-2960	150-7108	2	✓	-
21	103-0115	Multiline SRG 115				18 - 20	70	✓	150-2960	150-7108	2	✓	-
22	103-0210	Multiline SRG 210				18 - 20	80	✓	150-2960	150-7108	2	✓	-
23	103-0120	Multiline SRG 120				18 - 22	80	✓	150-7110	150-7108	2	✓	-
24	103-0125	Multiline SRG 125				18 - 22	70	✓	150-7110	150-7108	2	✓	-
25	103-0130	Multiline SRG 130				18 - 22	60	✓	150-7110	150-7108	2	✓	-

• Verilen ölçüler bağlayıcı değildir. Önerilen kurulum ölçüleridir. Albatür ürün özelliklerinde haber vermeden değişiklik yapılabilir. • The given dimension are not binding. These are recommended asamble dimensions. Albatür can make alteration to product specification without notice.

	OEM Kod OEM Code	Ürün Kodu Product Code	Sistem Tipi System Type	Panel Tipi Panel Type	Fren Yönü Brake Direc.	Panel mm	Taşıma Kg Capacity Kg	Video	Üst Ray Upper Rail	Alt Ray Lower Rail	Kapak Adeti Number of Doors	Yavaşlatıcı Dahil Soft Closer Including	Min. Kapak Genişlik mm Min. Cover Width mm
26	103-0135	Multiline SRG 135				18 - 22	60	✓	150-7110	150-7108	2	✓	-
27	103-0140	Multiline SRG 140				18 - 22	60	✓	150-7106	150-7108	2	✓	-
28	103-0145	Multiline SRG 145				18 - 22	60	✓	150-7106	150-7108	2	✓	-
29	103-7036	Multiline 7036				18 - 20	70	✓	150-2960	150-7108	2	Optional	-
30	103-7038	Multiline 7038				18 - 20	70	✓	150-2960	150-7108	2	Optional	-
31	103-7030	Multiline 7030				18 - 22	75	✓	150-7106	150-7108	2	Optional	-
32	103-7031	Multiline 7031				18 - 30	75	✓	150-7108	150-7108	2	Optional	-
33	103-7032	Multiline 7032				18 - 22	75	✓	150-7110	150-7108	2	Optional	-
34	103-7012	Multiline 7012				18 - 22	80		150-7002	150-7003	2	Optional	-
35	103-7010	Multiline 7010				18 - 22	80	✓	150-7002	150-7003	2	Optional	-
36	103-7011	Multiline 7011				18 - 22	70		150-7002	150-7102	2	Optional	-
37	103-7020	Multiline 7020				18 - 22	70		150-7108	150-7520	2	Optional	-
38	103-7060	Multiline 7060				18 - 30	60		151-0173	150-7104	2	Optional	-
39	103-7055	Multiline 7055				18 - 30	60		151-0173	150-7104	2	Optional	-
40	103-6400	Multiline 6400				18 - 30	45		150-7108	150-7102	2	Optional	-
41	103-7040	Multiline 7040				18 - 30	40		150-7041	150-7041	2	Optional	-
42	103-7045	Multiline 7045				18 - 30	45		150-7041	150-7041	2	Optional	-
43	103-6500	Multiline 6500				18	15		150-6520	150-6520	2	Optional	-
44	103-6510	Multiline 6510				18	15		150-6520	150-6520	2	Optional	-
45	103-6000	Multiline 6000				18	40		150-6001	150-6001	2	Optional	-
46	103-0171	Multiline 0171				18	30		151-0173	150-7171	2	Optional	-
47	103-6600	Multiline 6600				18	25		150-7092	-	2	Optional	-
48	103-6320	Multiline 6320				18	19		150-7041	-	2	Optional	-
49	103-6100	Multiline 6100				18	30		150-6125	-	2	-	-
50	103-7601	Multiline 7601				16 - 30	15	✓	150-7610	-	2	Optional	-

• Verilen ölçüler bağlayıcı değildir. Önerilen kurulum ölçüleridir. Albatür ürün özelliklerinde haber vermeden değişiklik yapabilir. • The given dimension are not binding. These are recommended asamble dimensions. Albatür can make alteration to product specification without notice.



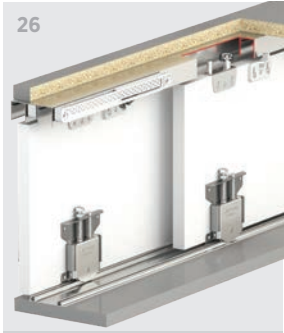

103-0135

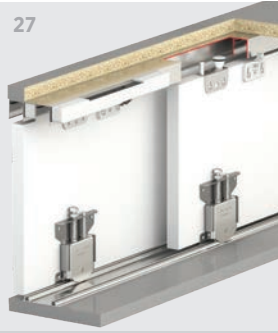

103-0140

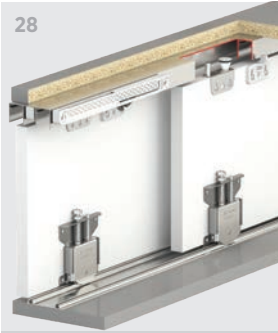

103-0145

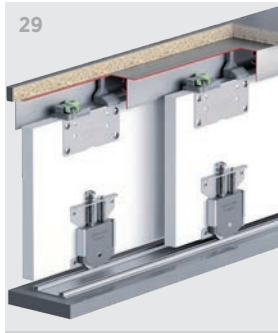

103-7036

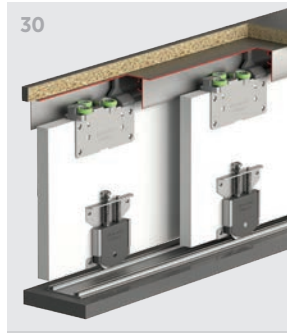

103-7038



103-7030

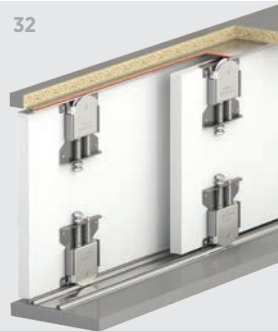

103-7031



103-7032

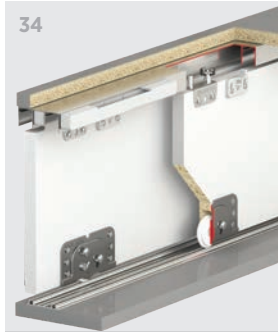

103-7012



103-7010



103-7011



103-7020

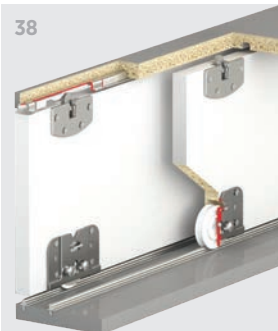

103-7060

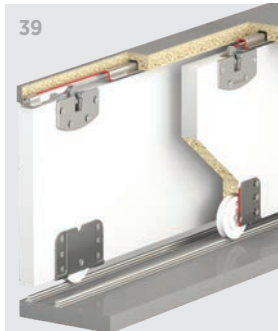

103-7055

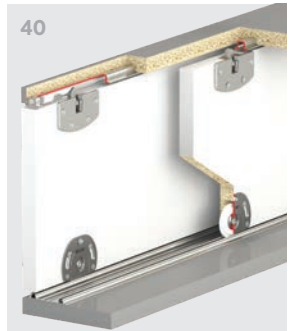

103-6400



103-7040

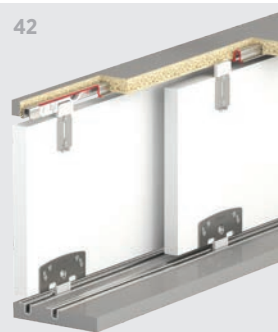

103-7045



103-6500



103-6510



103-6000

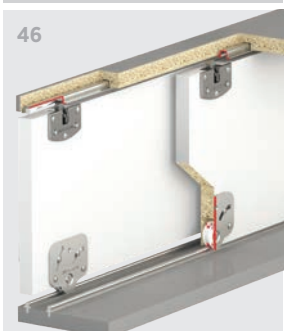

103-0171



103-6600



103-6320

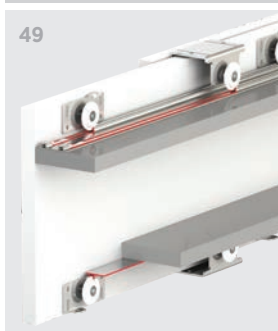

103-6100



103-7601

Multiline 1

103-1010

50 KG AYARLI SÜRME KAPAK SİSTEMİ
50 KG ADJUSTABLE SLIDING DOOR SYSTEM

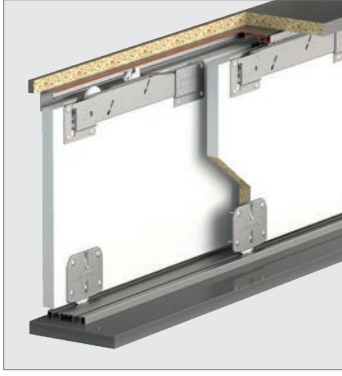

Bilgi / Information

- 1 Kutu İçeriği : 2 Kapak Yavaşlatıcı Mekanizma
- In 1 box : 2 Doors Mechanism with Soft Closers

Yavaşlatıcı Alternatifi / Soft Closer Alternative

- Sistem üzerinde entegre yavaşlatıcı mevcuttur.
- There is an integrated soft close on the system.



103-1010 1 Set İçeriği / 1 Set Includes

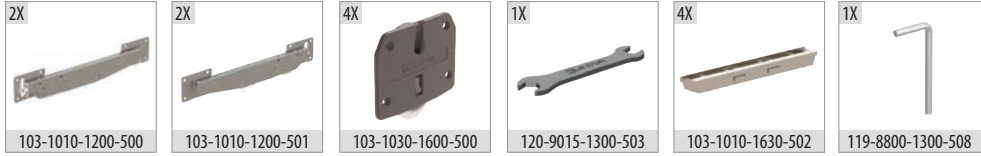

Ray Profilleri / Rail Profiles

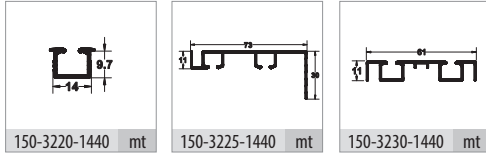

Kulp Profilleri / Handle Profiles

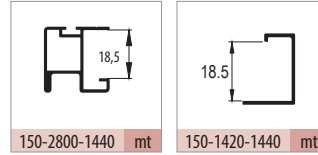

Opsiyonel / Optional

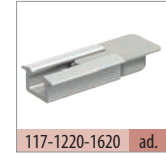

Teknik Detay / Technical Detail

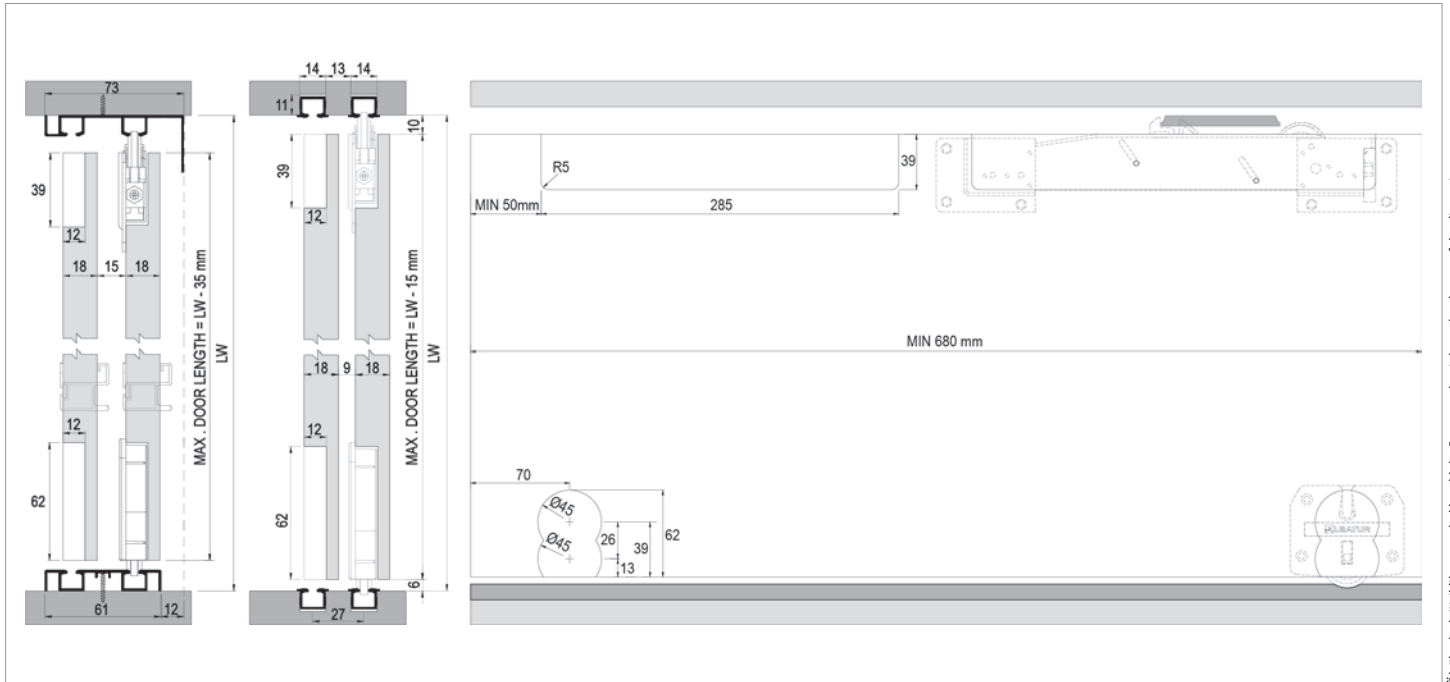

Ölçülerde değişiklik yapma hakkı saklıdır. Reserves the right to the change of the dimensions.

Kod / Code No	Açıklama / Description	Renk / Colour	Birim / Unit			Profil mt. / Profiles mt.	Bağ / Bnd.
103-1010-1200	Multiline 1 - Sürme Gardirop Sistemi / Sliding Wardrobe System	Silver	2 Kapak / 1 Set	12	360	-	-
145-1811-1600	Kıl Fital / Ec-Wf Hair Wick	Gri / Grey	mt.	300	7.200	-	-
150-3220-1440	Alüminyum Alt-Üst Ray Profili / Aluminium Bottom-Top Rail Profile	Bronz Parlak / Bronze Bright	mt.	-	-	-	3,0 20 ad/pcs
150-3225-1440	Alüminyum Üst Ray Profili / Aluminium Top Rail Profile	Bronz Parlak / Bronze Bright	mt.	-	-	-	3,0 6 ad/pcs
150-3230-1440	Alüminyum Alt-Üst Ray Profili / Aluminium Bottom-Top Rail Profile	Bronz Parlak / Bronze Bright	mt.	-	-	-	3,0 10 ad/pcs
150-7520-1410	Alüminyum Alt Ray Profili / Aluminium Bottom Rail Profile	Eloksal / Mat Anodized	mt.	-	-	-	3,0 30 ad/pcs
150-2800-1440	Alüminyum Kulp Profili / Aluminium Handle Profile	Bronz Parlak / Bronze Bright	mt.	-	-	-	3,0 6 ad/pcs
150-1420-1440	Alüminyum Kapama Profili / Aluminium Closure Profile	Bronz Parlak / Bronze Bright	mt.	-	-	-	3,0 10 ad/pcs

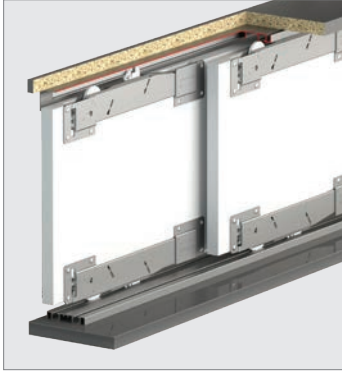

Bilgi / Information

- 1 Kutu İçeriği : 2 Kapak Yavaşlatıcı Mekanizma
- In 1 box : 2 Doors Mechanism with Soft Closers

Yavaşlatıcı Alternatifi / Soft Closer Alternative

- Sistem üzerinde entegre yavaşlatıcı mevcuttur.
- There is an integrated soft close on the system.



103-1020 1 Set İçeriği / 1 Set Includes

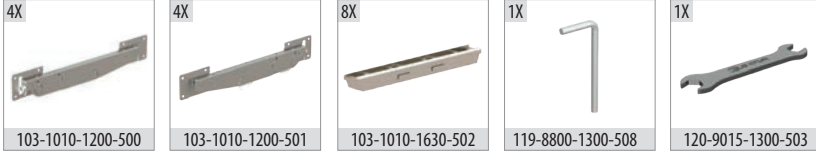

Ray Profilleri / Rail Profiles

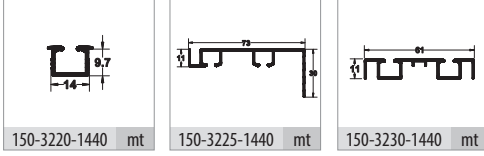

Kulp Profilleri / Handle Profiles

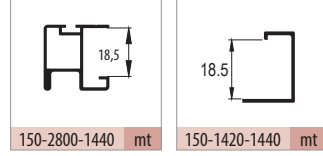

Opsiyonel / Optional

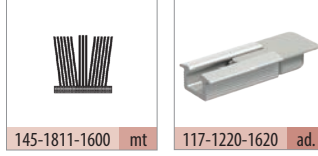

Teknik Detay / Technical Detail

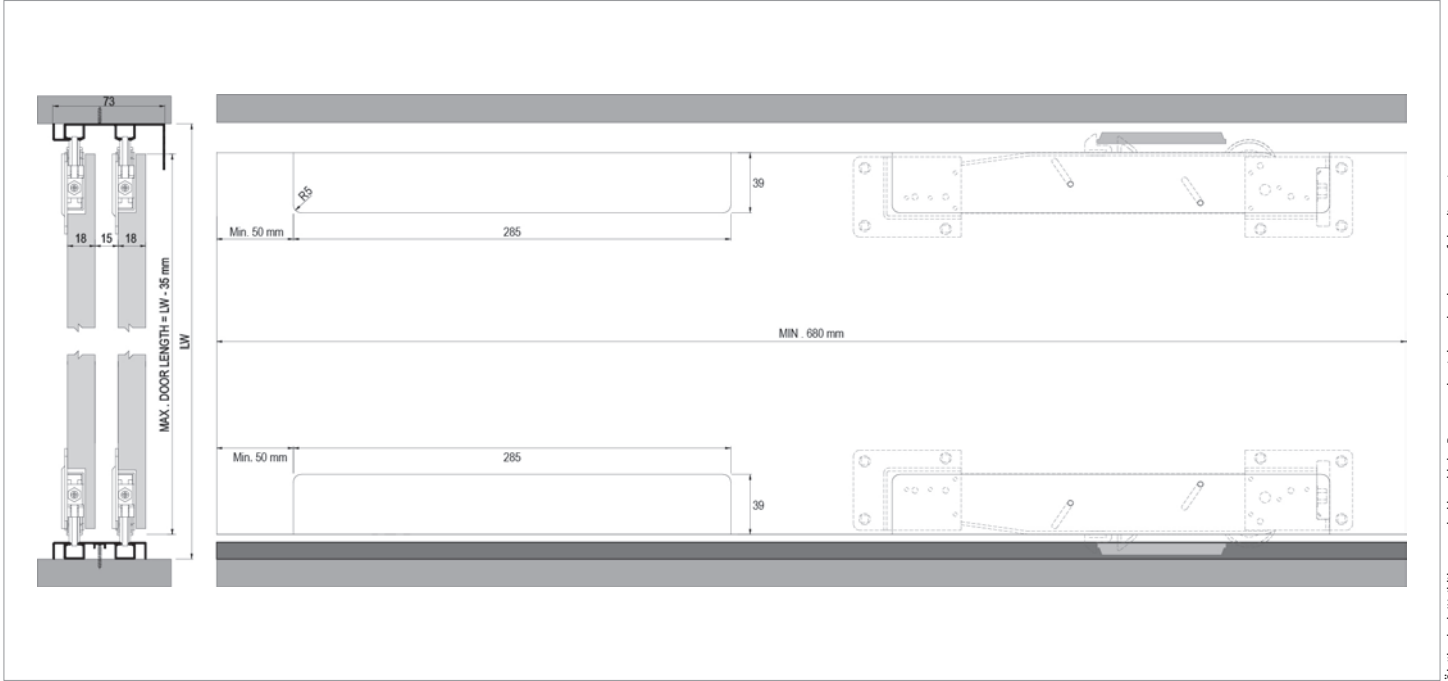

Ölçülerde değişiklik yapma hakkı saklıdır. Reserves the right to the change of the dimensions.

Kod / Code No	Açıklama / Description	Renk / Colour	Birim / Unit			Profil mt. / Profiles mt.	Bağ / Bnd.
103-1020-1200	Multiline 2 - Sürme Gardrop Sistemi / Sliding Wardrobe System	Silver	2 Kapak / 1 Set	5	90	- - -	-
145-1811-1600	Kıl Fitil / Ec-Wf Hair Wick	Gri / Grey	mt.	300	7.200	- - -	-
150-3220-1440	Alüminyum Alt-Üst Ray Profili / Aluminium Bottom-Top Rail Profile	Bronz Parlak / Bronze Bright	mt.	-	-	- - -	3,0 20 ad/pcs
150-3225-1440	Alüminyum Üst Ray Profili / Aluminium Top Rail Profile	Bronz Parlak / Bronze Bright	mt.	-	-	- - -	3,0 6 ad/pcs
150-3230-1440	Alüminyum Alt-Üst Ray Profili / Aluminium Bottom-Top Rail Profile	Bronz Parlak / Bronze Bright	mt.	-	-	- - -	3,0 10 ad/pcs
150-2800-1440	Alüminyum Kulp Profili / Aluminium Handle Profile	Bronz Parlak / Bronze Bright	mt.	-	-	- - -	3,0 6 ad/pcs
150-1420-1440	Alüminyum Kapama Profili / Aluminium Closure Profile	Bronz Parlak / Bronze Bright	mt.	-	-	- - -	3,0 10 ad/pcs

Multiline 3

103-1030

40 KG AYARLI SÜRME KAPAK SİSTEMİ
40 KG ADJUSTABLE SLIDING DOOR SYSTEM

Özel Üretim
Special Production



103-1030 1 Set İçeriği / 1 Set Includes Opsiyonel / Optional



Ray Profilleri / Rail Profiles

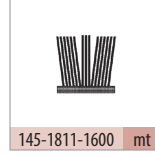
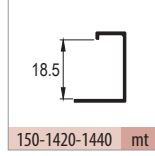
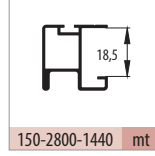
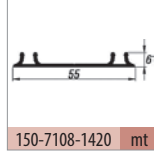
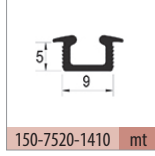
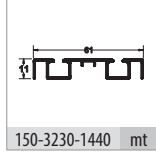
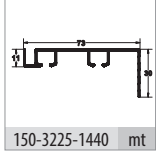
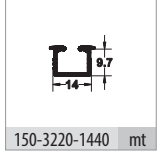

Teknik Detay / Technical Detail

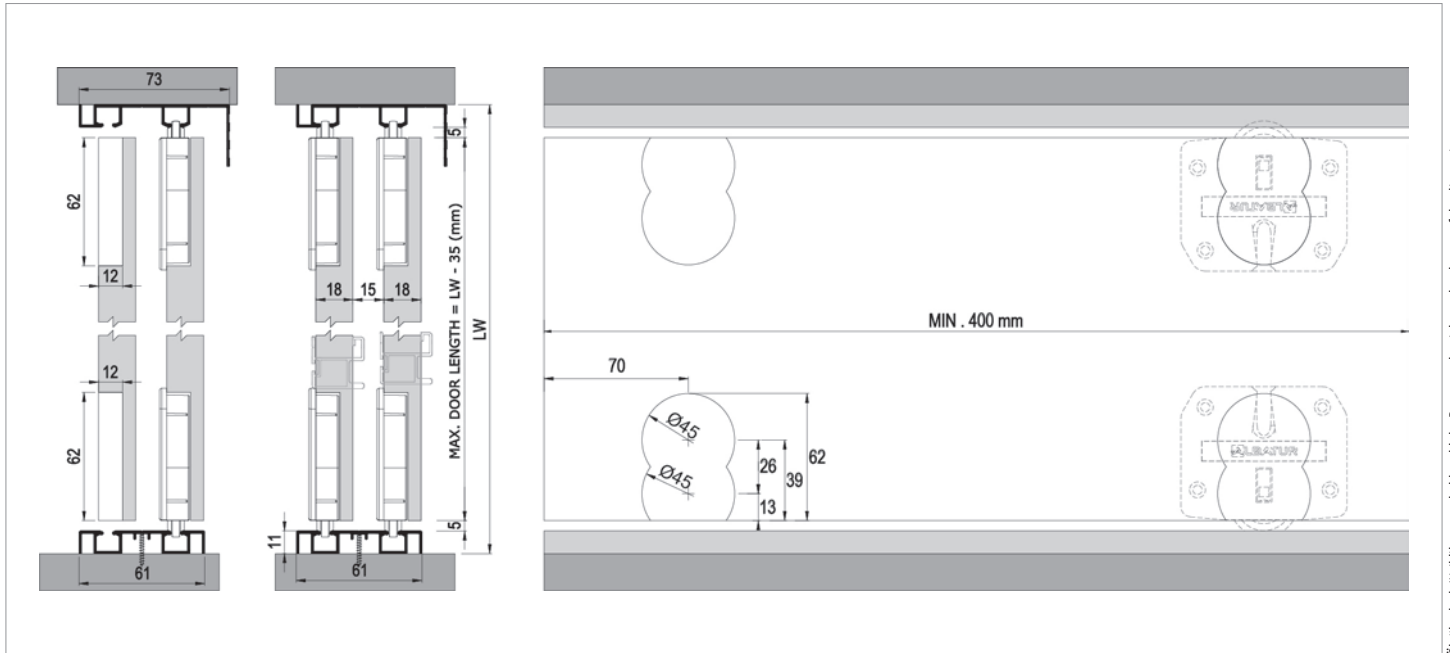

Ölçülerde değişiklik yapma hakkı saklıdır. Reserves the right to the change of the dimensions.

Kod / Code No	Açıklama / Description	Renk / Colour	Birim / Unit			Profil mt. / Profiles mt.	Bağ / Bnd.
103-1030-1600	Multiline 3 - Sürme Gardrop Sistemi / Sliding Wardrobe System	Silver	2 Kapak / 1 Set	16	512	- - -	-
145-1811-1600	Kıl Fital / Ec-Wf Hair Wick	Gri / Grey	mt.	300	7.200	- - -	-
150-3220-1440	Alüminyum Alt-Üst Ray Profili / Aluminium Bottom-Top Rail Profile	Bronz Parlak / Bronze Bright	mt.	-	-	- - 3,0	20 ad/pcs
150-3225-1440	Alüminyum Üst Ray Profili / Aluminium Top Rail Profile	Bronz Parlak / Bronze Bright	mt.	-	-	- - 3,0	6 ad/pcs
150-3230-1440	Alüminyum Alt-Üst Ray Profili / Aluminium Bottom-Top Rail Profile	Bronz Parlak / Bronze Bright	mt.	-	-	- - 3,0	10 ad/pcs
150-7108-1420	Alüminyum Alt Ray Profili / Aluminium Bottom Rail Profile	Parlak / Bright	mt.	-	-	- - 3,0	12 ad/pcs
150-7520-1410	Alüminyum Alt-Üst Ray Profili / Aluminium Bottom-Top Rail Profile	Eloksal / Mat Anodized	mt.	-	-	- - 3,0	30 ad/pcs
150-2800-1440	Alüminyum Kulp Profili / Aluminium Handle Profile	Bronz Parlak / Bronze Bright	mt.	-	-	- - 3,0	6 ad/pcs
150-1420-1440	Alüminyum Kapama Profili / Aluminium Closure Profile	Bronz Parlak / Bronze Bright	mt.	-	-	- - 3,0	10 ad/pcs

Multiline 4

103-1040

50 KG AYARLI SÜRME KAPAK SİSTEMİ
50 KG ADJUSTABLE SLIDING DOOR SYSTEM

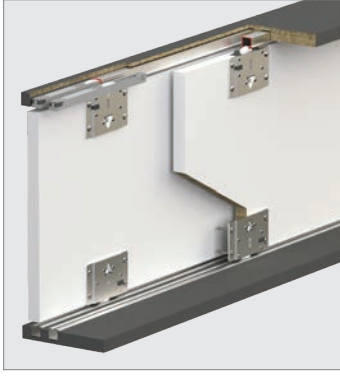

Bilgi / Information

- 1 Kutu İçeriği : 2 Kapak Mekanizma + 4 Ad Yavaşlatıcı
- In 1 box : 2 Doors Mechanism + 4 Pcs Soft Closers



103-1040 1 Set İçeriği / 1 Set Includes

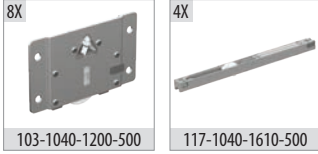

Ray Profilleri / Rail Profiles

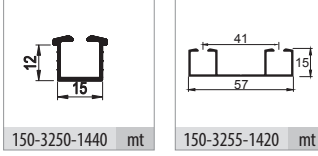

Kulp Profilleri / Handle Profiles

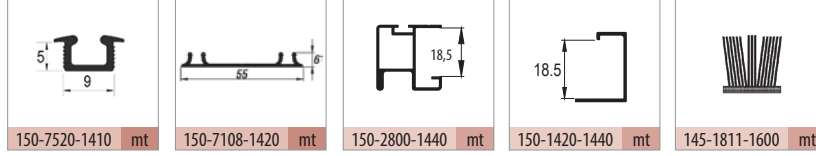

Teknik Detay / Technical Detail

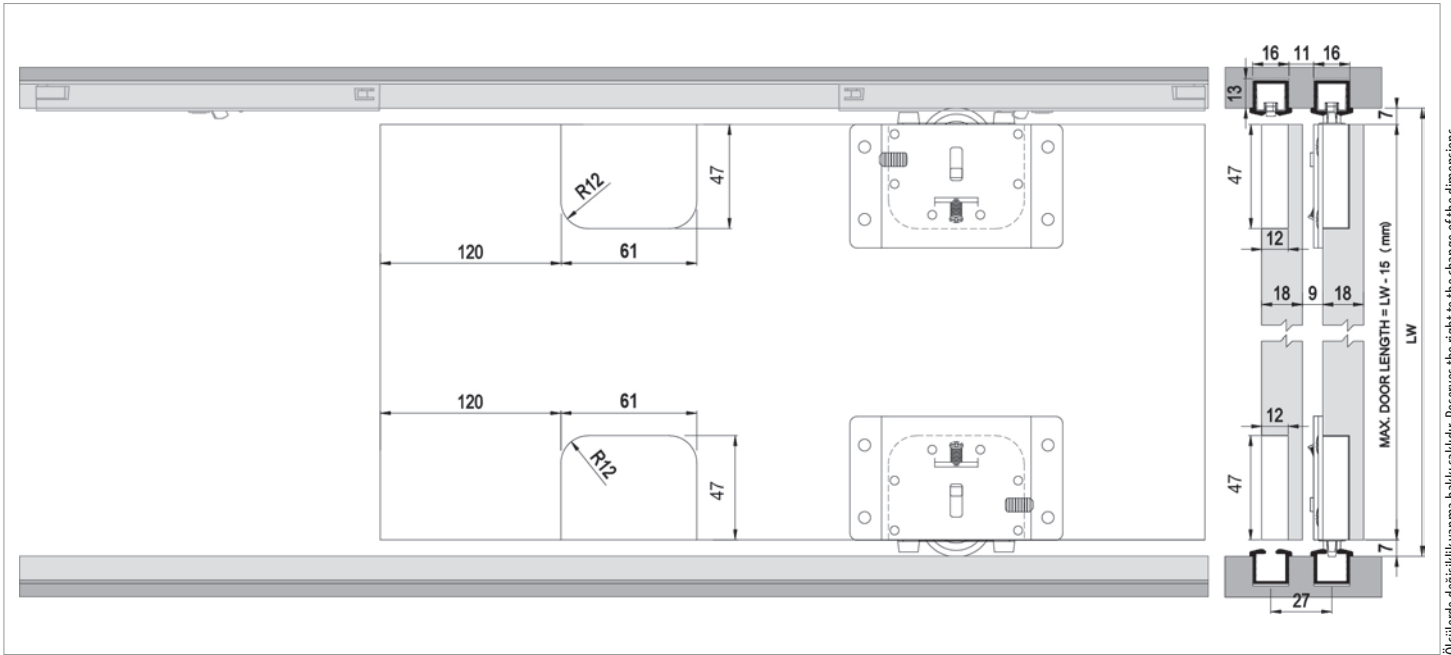

Kod / Code No	Açıklama / Description	Renk / Colour	Birim / Unit			Profil mt. / Profiles mt.	Bağ / Bnd.
103-1040-1200	Multiline 4 - Sürme Gardirop Sistemi / Sliding Wardrobe System	Silver	2 Kapak / 1 Set	12	360	-	-
145-1811-1600	Kıl Fital / Ec-Wf Hair Wick	Gri / Grey	mt.	300	7.200	-	-
150-3250-1440	Alüminyum Alt-Üst Ray Profili / Aluminium Bottom-Top Rail Profile	Bronz Parlak / Bronze Bright	mt.	-	-	-	3,0 4 ad/pcs
150-3255-1420	Alüminyum Üst Ray Profili / Aluminium Top Rail Profile	Parlak / Bright	mt.	-	-	-	3,0 12 ad/pcs
150-7108-1420	Alüminyum Alt Ray Profili / Aluminium Bottom Rail Profile	Parlak / Bright	mt.	-	-	-	3,0 12 ad/pcs
150-7520-1410	Alüminyum Alt Ray Profili / Aluminium Bottom Rail Profile	Eloksal / Mat Anodized	mt.	-	-	-	3,0 30 ad/pcs
150-2800-1440	Alüminyum Kulp Profili / Aluminium Handle Profile	Bronz Parlak / Bronze Bright	mt.	-	-	-	3,0 6 ad/pcs
150-1420-1440	Alüminyum Kapama Profili / Aluminium Closure Profile	Bronz Parlak / Bronze Bright	mt.	-	-	-	3,0 10 ad/pcs

Multiline 5

103-1050

20 KG AYARLI SÜRME KAPAK SİSTEMİ
20 KG ADJUSTABLE SLIDING DOOR SYSTEM



■ Yavaşlatıcı Alternatifi / Soft Closer Alternative

- Sistem üzerinde entegre yavaşlatıcı mevcuttur.
- There is an integrated soft close on the system.



■ 103-1050 1 Takım İçeriği / 1 Kit Includes

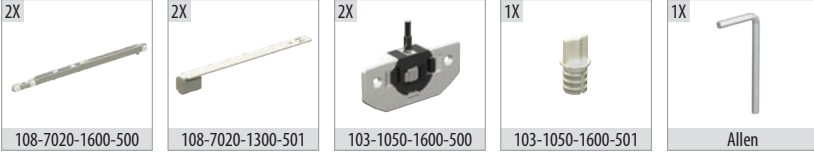

■ Ray Profilleri / Rail Profiles

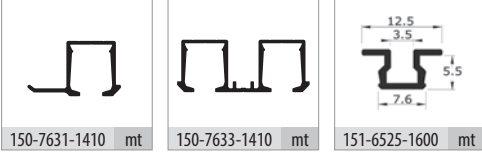

■ Teknik Detay / Technical Detail

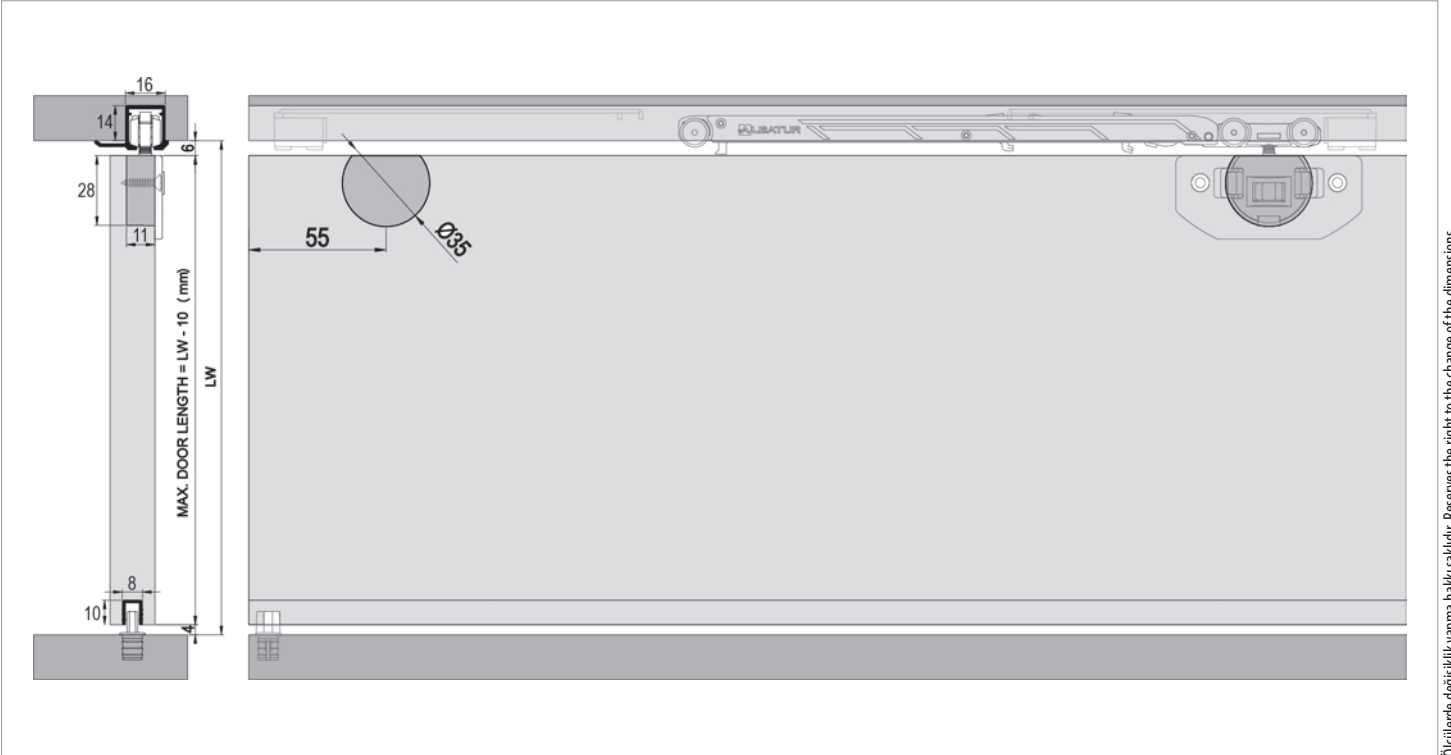

Ölçülerde değişiklik yapma hakkı saklıdır. Reserves the right to the change of the dimensions.

Kod / Code No	Açıklama / Description	Renk / Colour	Birim / Unit			Profil mt. / Profiles mt.	Bağ / Bnd.
103-1050-1600	Multiline 5 - Sürme Gardirop Sistemi / Sliding Wardrobe System	Gri / Grey	1 Kapak / 1 Kit	12	360	- - -	-
150-7631-1410	Alüminyum Üst Ray Profili / Aluminium Top Rail Profile	Eloksal / Mat Anodized	mt.	-	-	- - 3,0	10 ad/pcs
150-7633-1410	Alüminyum Üst Ray Profili / Aluminium Top Rail Profile	Eloksal / Mat Anodized	mt.	-	-	- - 3,0	10 ad/pcs
151-6525-1600	PVC Ray Profili / PVC Rail Profile	Gri / Grey	mt.	-	-	- - 3,0	30 ad/pcs

Multiline 7

103-1070

50 KG AYARLI SÜRME KAPAK SİSTEMİ
50 KG ADJUSTABLE SLIDING DOOR SYSTEM



Bilgi / Information

- 1 Kutu İçeriği : 2 Kapak Yavaşlatıcı Mekanizma
- In 1 box : 2 Doors Mechanism with Soft Closers

Yavaşlatıcı Alternatifi / Soft Closer Alternative

- Sistem üzerinde entegre yavaşlatıcı mevcuttur.
- The system has integrated soft closer.



103-1070 1 Set İçeriği / 1 Set Includes

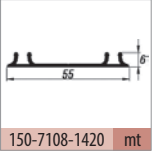
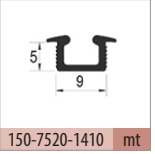
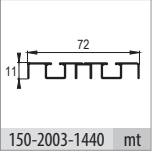
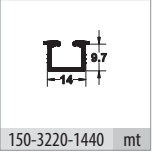
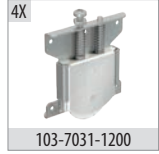
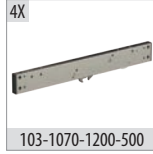

Ray Profilleri / Rail Profiles

Kulp Profilleri / Handle Profiles

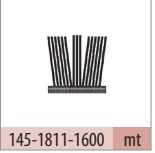
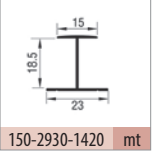
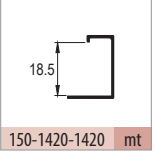
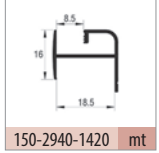
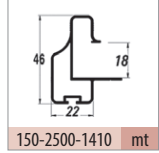
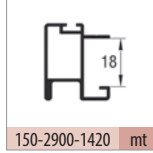

Teknik Detay / Technical Detail

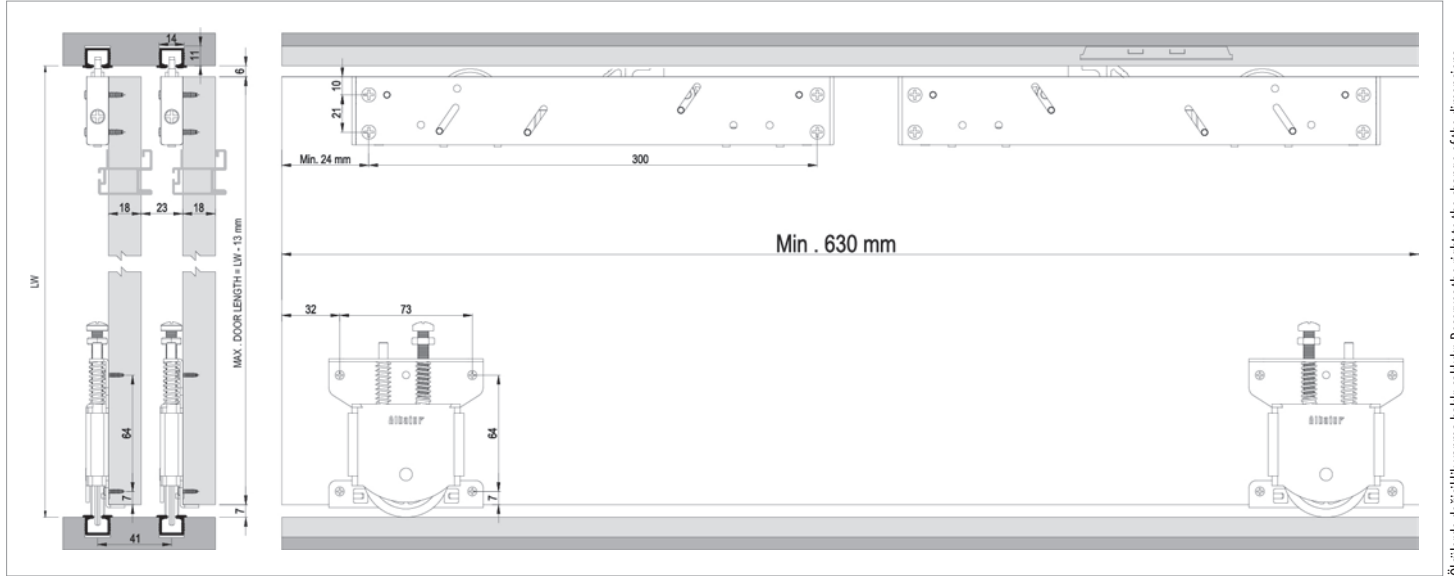

Ölçülerde değişiklik yapma hakkı saklıdır. Reserves the right to the change of the dimensions.

Kod / Code No	Açıklama / Description	Renk / Colour	Birim / Unit			Profil mt. / Profiles mt.	Bağ / Bnd.
103-1070-1200	Multiline 7 Sürme Gardrop Sistemi / Sliding Wardrobe System	Silver	2 Kapak / 1 Set	12	360	- - -	-
145-1811-1600	Kıl Fital / Ec-Wf Hair Wick	Gri / Grey	mt.	300	7.200	- - -	-
150-3220-1440	Alüminyum Alt-Üst Ray Profili / Aluminium Bottom-Top Rail Profile	Bronz Parlak / Bronze Bright	mt.	-	-	- - 3,0	20 ad/pcs
150-2003-1440	Alüminyum Alt-Üst Ray Profili / Aluminium Bottom-Top Rail Profile	Bronz Parlak / Bronze Bright	mt.	-	-	- - 3,0	12 ad/pcs
150-7108-1420	Alüminyum Alt Ray Profili / Aluminium Bottom Rail Profile	Parlak / Bright	mt.	-	-	- - 3,0	12 ad/pcs
150-7520-1410	Alüminyum Alt Ray Profili / Aluminium Bottom Rail Profile	Eloksal / Mat Anodized	mt.	-	-	- - 3,0	30 ad/pcs
150-2900-1420	Alüminyum Kulp Profili / Aluminium Handle Profile	Parlak / Bright	mt.	-	-	2,0 2,5 3,0	6 ad/pcs
150-2500-1410	Alüminyum Kulp Profili / Aluminium Handle Profile	Eloksal / Mat Anodized	mt.	-	-	- - 3,0	6 ad/pcs
150-2940-1420	Alüminyum Orta Kayıt / Aluminium Horizontal Central	Parlak / Bright	mt.	-	-	- - 3,0	10 ad/pcs
150-1420-1420	Alüminyum Kapama Profili / Aluminium Closure Profile	Parlak / Bright	mt.	-	-	- - 3,0	10 ad/pcs
150-2930-1420	Alüminyum Orta Kayıt / Aluminium Horizontal Central	Parlak / Bright	mt.	-	-	- - 3,0	10 ad/pcs

Multiline 8

103-1080

50 KG AYARLI SÜRME KAPAK SİSTEMİ
50 KG ADJUSTABLE SLIDING DOOR SYSTEM



Bilgi / Information

- 1 Kutu İçeriği : 2 Kapak Mekanizma + 4 Ad Yavaşlatıcı
- In 1 box : 2 Doors Mechanism + 4 Pcs Soft Closers



103-1080 1 Set İçeriği / 1 Set Includes

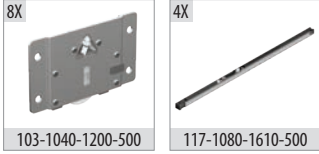

Ray Profilleri / Rail Profiles

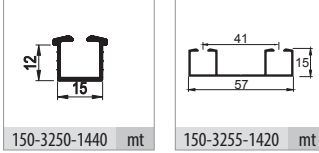

Kulp Profilleri / Handle Profiles

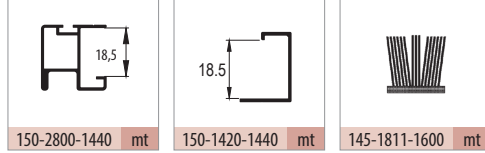

Teknik Detay / Technical Detail

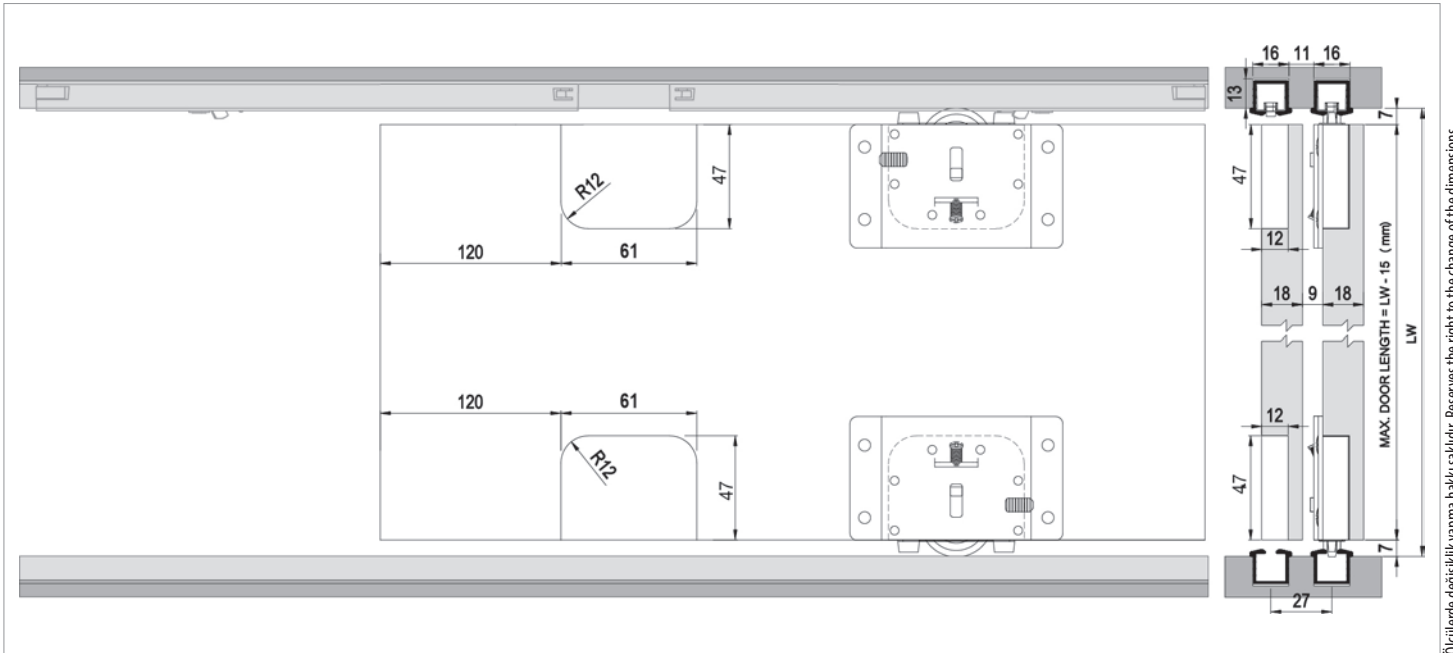

Ölçülerde değişiklik yapma hakkı saklıdır. Reserves the right to the change of the dimensions.

Kod / Code No	Açıklama / Description	Renk / Colour	Birim / Unit			Profil mt. / Profiles mt.	Bağ / Bnd.
103-1080-1200	Multiline 8 - Sürme Gardrop Sistemi / Sliding Wardrobe System	Silver	2 Kapak / 1 Set	12	360	-	-
145-1811-1600	Kıl Fital / Ec-Wf Hair Wick	Gri / Grey	mt.	300	7.200	-	-
150-3250-1440	Alüminyum Alt-Üst Ray Profili / Aluminium Bottom-Top Rail Profile	Bronz Parlak / Bronze Bright	mt.	-	-	-	3,0 4 ad/pcs
150-3255-1420	Alüminyum Üst Ray Profili / Aluminium Top Rail Profile	Parlak / Bright	mt.	-	-	-	3,0 12 ad/pcs
150-7108-1420	Alüminyum Alt Ray Profili / Aluminium Bottom Rail Profile	Parlak / Bright	mt.	-	-	-	3,0 12 ad/pcs
150-7520-1410	Alüminyum Alt Ray Profili / Aluminium Bottom Rail Profile	Eloksal / Mat Anodized	mt.	-	-	-	3,0 30 ad/pcs
150-2800-1440	Alüminyum Kulp Profili / Aluminium Handle Profile	Bronz Parlak / Bronze Bright	mt.	-	-	-	3,0 6 ad/pcs
150-1420-1440	Alüminyum Kapama Profili / Aluminium Closure Profile	Bronz Parlak / Bronze Bright	mt.	-	-	-	3,0 10 ad/pcs

Multiline 9

103-1090

45 KG AYARLI SÜRME KAPAK SİSTEMİ
45 KG ADJUSTABLE SLIDING DOOR SYSTEM

Yeni Ürün
New Product

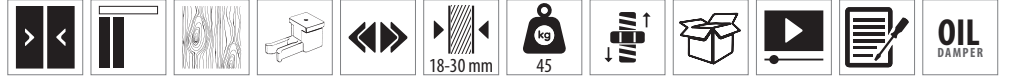

Yavaşlatıcı Alternatifi / Soft Closer Alternative

117-6959-1600 <<>>



103-1090 1 Takım İçeriği / 1 Kit Includes

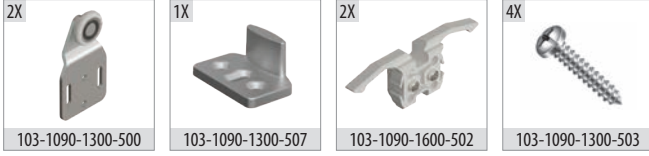

117-6959 1 Takım İçeriği / 1 Kit Includes

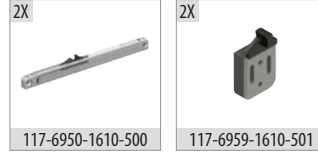

103-1091 1 Takım İçeriği / 1 Kit Includes

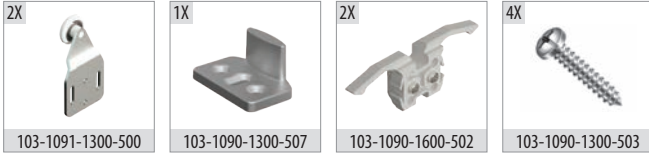

Ray Profilleri / Rail Profiles

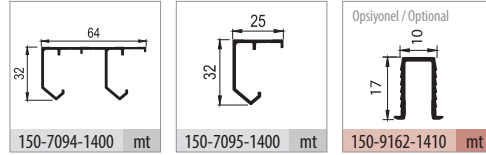

Teknik Detay / Technical Detail



Ölçülerde değişiklik yapma hakkı saklıdır. Reserves the right to the change of the dimensions.

Kod / Code No	Açıklama / Description	Renk / Colour	Birim / Unit			Profil mt. / Profiles mt.	Bağ / Bnd.
103-1090-1300	Multiline 9 - Sürme Kapak Sistemi / Sliding Door System	Silver	1 Kapak / 1 Kit	24	768	- - -	-
103-1091-1300	Multiline 9 - Sürme Kapak Sistemi / Sliding Door System	Silver	1 Kapak / 1 Kit	24	768	- - -	-
117-6959-1610	50 Kg Yavaşlatıcı Mekanizma / 50 Kg Soft Closer Mechanism	Gri / Grey	1 Takım / 1 Kit	50	1.250	- - -	-
150-7094-1400	Alüminyum Üst Ray Profili / Aluminium Top Rail Profile	Pres / Uncoated	mt.	-	-	- - 3,0	6 ad/pcs
150-7095-1400	Alüminyum Üst Ray Profili / Aluminium Top Rail Profile	Pres / Uncoated	mt.	-	-	- - 3,0	6 ad/pcs
150-9162-1410	Alüminyum Alt Klavuz Profili / Aluminium Bottom Slider Profile	Eloksal / Mat Anodized	mt.	-	-	- - 3,0	20 ad/pcs

Multiline 10

103-1100

50 KG AYARLI SÜRME KAPAK SİSTEMİ
50 KG ADJUSTABLE SLIDING DOOR SYSTEM

Yeni Ürün
New Product



Bilgi / Information

- 1 Kutu İçeriği : 2 Kapak Mekanizma + 4 Ad Yavaşlatıcı
- In 1 box : 2 Doors Mechanism + 4 Pcs Soft Closers



103-1100 1 Set İçeriği / 1 Set Includes

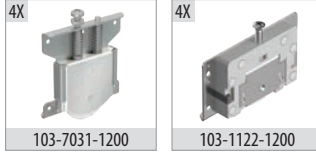

103-7031-1200

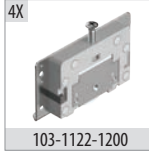

103-1122-1200

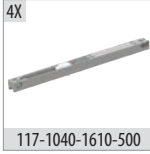

117-1040-1610-500

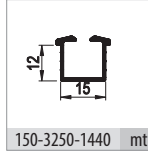

150-3250-1440 mt

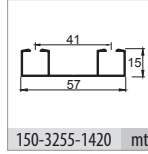

150-3255-1420 mt

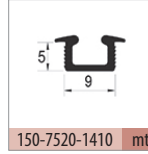

150-7520-1410 mt

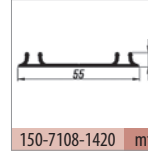

150-7108-1420 mt

Ray Profilleri / Rail Profiles

Kulp Profilleri / Handle Profiles

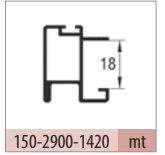

150-2900-1420 mt

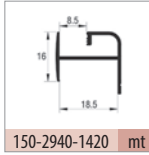

150-2940-1420 mt

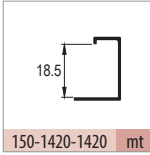

150-1420-1420 mt

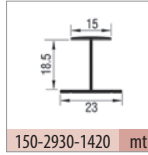

150-2930-1420 mt

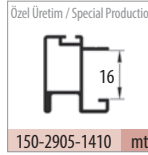

150-2905-1410 mt

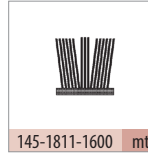

145-1811-1600 mt

Teknik Detay / Technical Detail

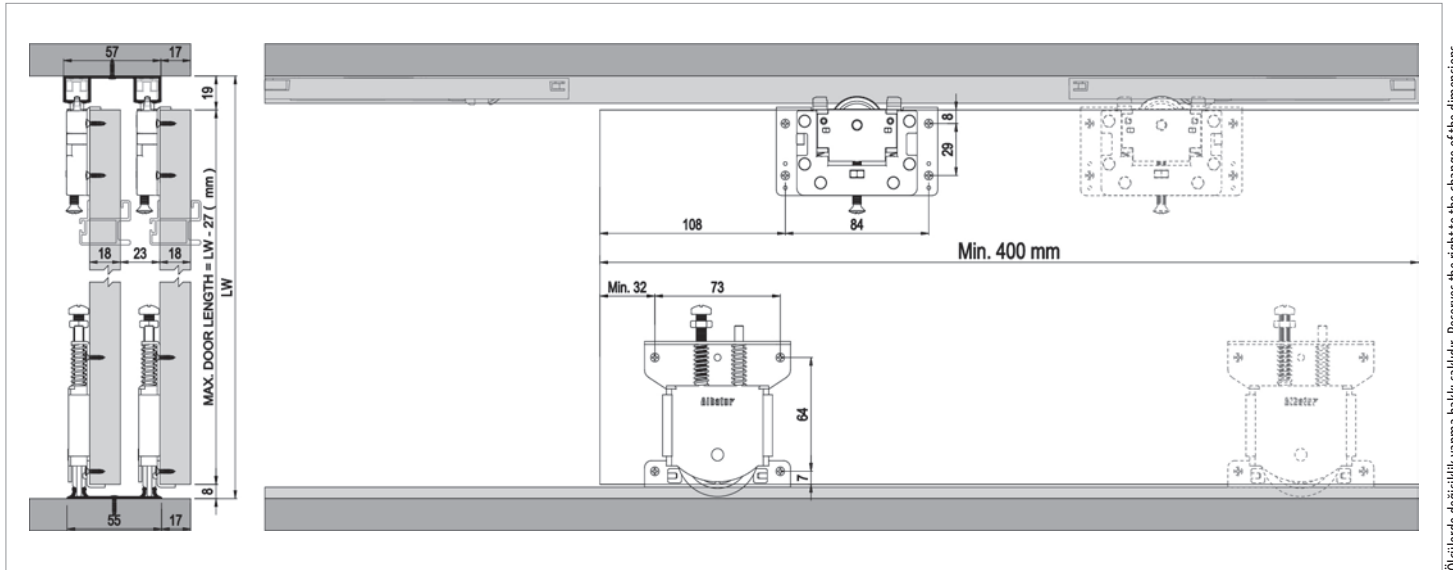

Ölçülerde değişiklik yapma hakkı saklıdır. Reserves the right to the change of the dimensions.

Kod / Code No	Açıklama / Description	Renk / Colour	Birim / Unit			Profil mt. / Profiles mt.	Bağ / Bnd.
103-1100-1200	Multiline 10 - Sürme Gardirop Sistemi / Sliding Wardrobe System	Silver	2 Kapak / 1 Set	12	360	- - -	-
145-1811-1600	Kıl Fital / Ec-Wf Hair Wick	Gri / Grey	mt.	300	7.200	- - -	-
150-3250-1440	Alüminyum Alt-Üst Ray Profili / Aluminium Bottom-Top Rail Profile	Bronz Parlak / Bronze Bright	mt.	-	-	- - 3,0	4 ad/pcs
150-3255-1420	Alüminyum Üst Ray Profili / Aluminium Top Rail Profile	Parlak / Bright	mt.	-	-	- - 3,0	12 ad/pcs
150-7108-1420	Alüminyum Alt Ray Profili / Aluminium Bottom Rail Profile	Parlak / Bright	mt.	-	-	- - 3,0	12 ad/pcs
150-7520-1410	Alüminyum Alt Ray Profili / Aluminium Bottom Rail Profile	Eloksal / Mat Anodized	mt.	-	-	- - 3,0	30 ad/pcs
150-2900-1420	Alüminyum Kulp Profili / Aluminium Handle Profile	Parlak / Bright	mt.	-	-	2,0 2,5 3,0	6 ad/pcs
150-2940-1420	Alüminyum Orta Kayıt / Aluminium Horizontal Central	Parlak / Bright	mt.	-	-	- - 3,0	10 ad/pcs
150-1420-1420	Alüminyum Kapama Profili / Aluminium Closure Profile	Parlak / Bright	mt.	-	-	- - 3,0	10 ad/pcs
150-2930-1420	Alüminyum Orta Kayıt / Aluminium Horizontal Central	Parlak / Bright	mt.	-	-	- - 3,0	10 ad/pcs
150-2905-1410	Alüminyum Kulp Profili / Aluminium Handle Profile	Eloksal / Mat Anodized	mt.	-	-	- - 3,0	6 ad/pcs



Bilgi / Information

- 1 Kutu İçeriği : 2 Kapak Mekanizma + 4 Ad Yavaşlatıcı
- In 1 box : 2 Door Mechanism + 4 Pcs Soft Closers



103-1110 1 Set İçeriği / 1 Set Includes

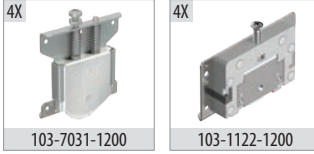

Ray Profilleri / Rail Profiles

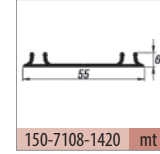
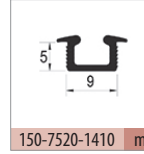
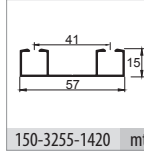
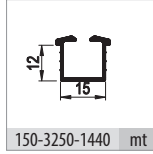

Kulp Profilleri / Handle Profiles

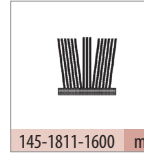
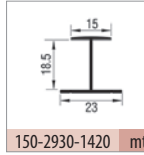
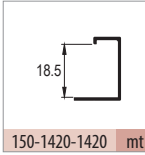
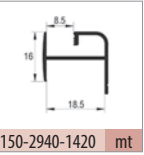
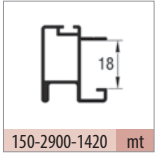

Teknik Detay / Technical Detail

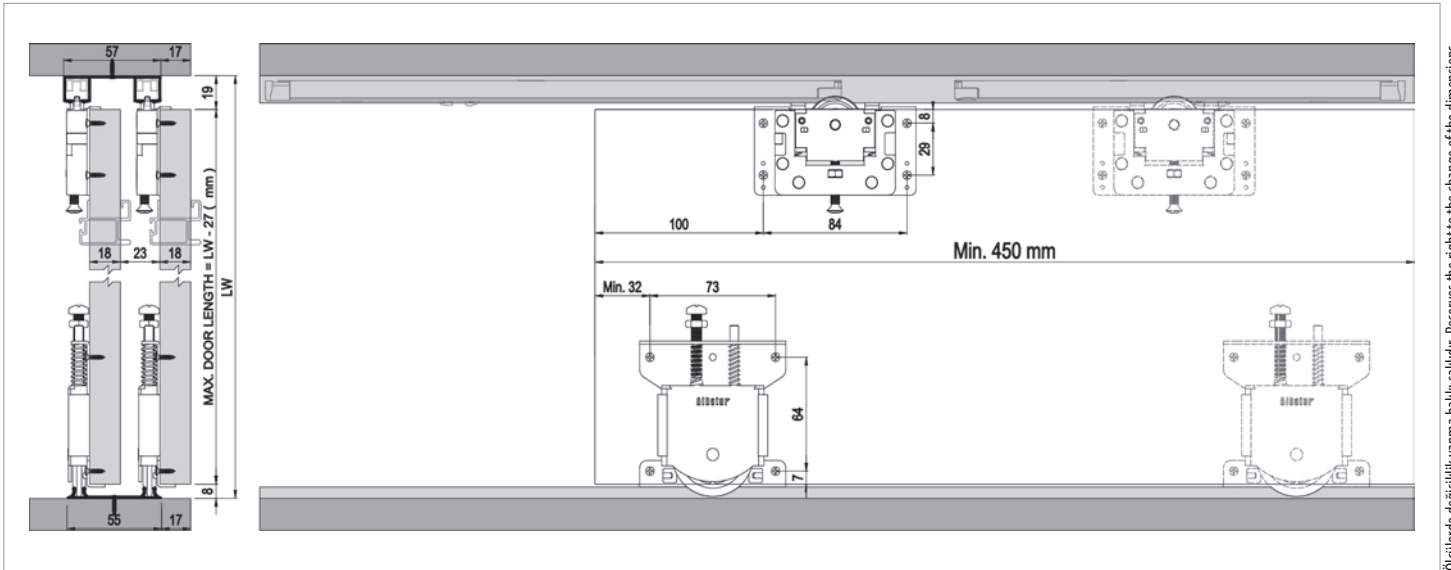

Ölçülerde değişiklik yapma hakkı saklıdır. Reserves the right to the change of the dimensions.

Kod / Code No	Açıklama / Description	Renk / Colour	Birim / Unit			Profil mt. / Profiles mt.	Bağ / Bnd.
103-1110-1200	Multiline 11 - Sürme Gardirop Sistemi / Sliding Wardrobe System	Silver	2 Kapak / 1 Set	12	360	- - -	-
145-1811-1600	Kıl Fital / Ec-Wf Hair Wick	Gri / Grey	mt.	300	7.200	- - -	-
150-3250-1440	Alüminyum Alt-Üst Ray Profili / Aluminium Bottom-Top Rail Profile	Bronz Parlak / Bronze Bright	mt.	-	-	- - 3,0	4 ad/pcs
150-3255-1420	Alüminyum Üst Ray Profili / Aluminium Top Rail Profile	Parlak / Bright	mt.	-	-	- - 3,0	12 ad/pcs
150-7108-1420	Alüminyum Alt Ray Profili / Aluminium Bottom Rail Profile	Parlak / Bright	mt.	-	-	- - 3,0	12 ad/pcs
150-7520-1410	Alüminyum Alt Ray Profili / Aluminium Bottom Rail Profile	Eloksal / Mat Anodized	mt.	-	-	- - 3,0	30 ad/pcs
150-2900-1420	Alüminyum Kulp Profili / Aluminium Handle Profile	Parlak / Bright	mt.	-	-	2,0 2,5 3,0	6 ad/pcs
150-2940-1420	Alüminyum Orta Kayıt / Aluminium Horizontal Central	Parlak / Bright	mt.	-	-	- - 3,0	10 ad/pcs
150-1420-1420	Alüminyum Kapama Profili / Aluminium Closure Profile	Parlak / Bright	mt.	-	-	- - 3,0	10 ad/pcs
150-2930-1420	Alüminyum Orta Kayıt / Aluminium Horizontal Central	Parlak / Bright	mt.	-	-	- - 3,0	10 ad/pcs
150-2905-1410	Alüminyum Kulp Profili / Aluminium Handle Profile	Eloksal / Mat Anodized	mt.	-	-	- - 3,0	6 ad/pcs



Bilgi / Information

- 1 Kutu İçeriği : 2 Kapak Mekanizma + 4 Ad Yavaşlatıcı
- In 1 box : 2 Door Mechanism + 4 Pcs Soft Closers



103-1120 1 Set İçeriği / 1 Set Includes

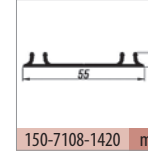
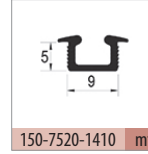
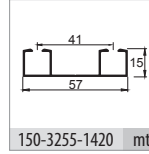
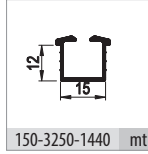
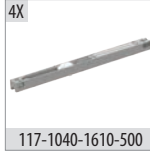
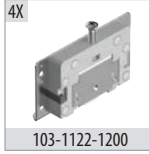
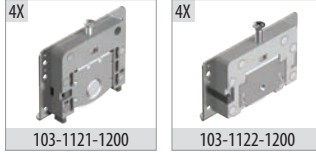

Ray Profilleri / Rail Profiles

Kulp Profilleri / Handle Profiles

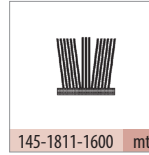
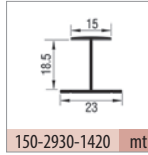
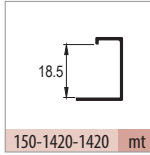
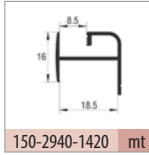
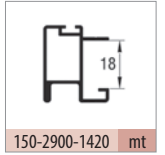

Teknik Detay / Technical Detail

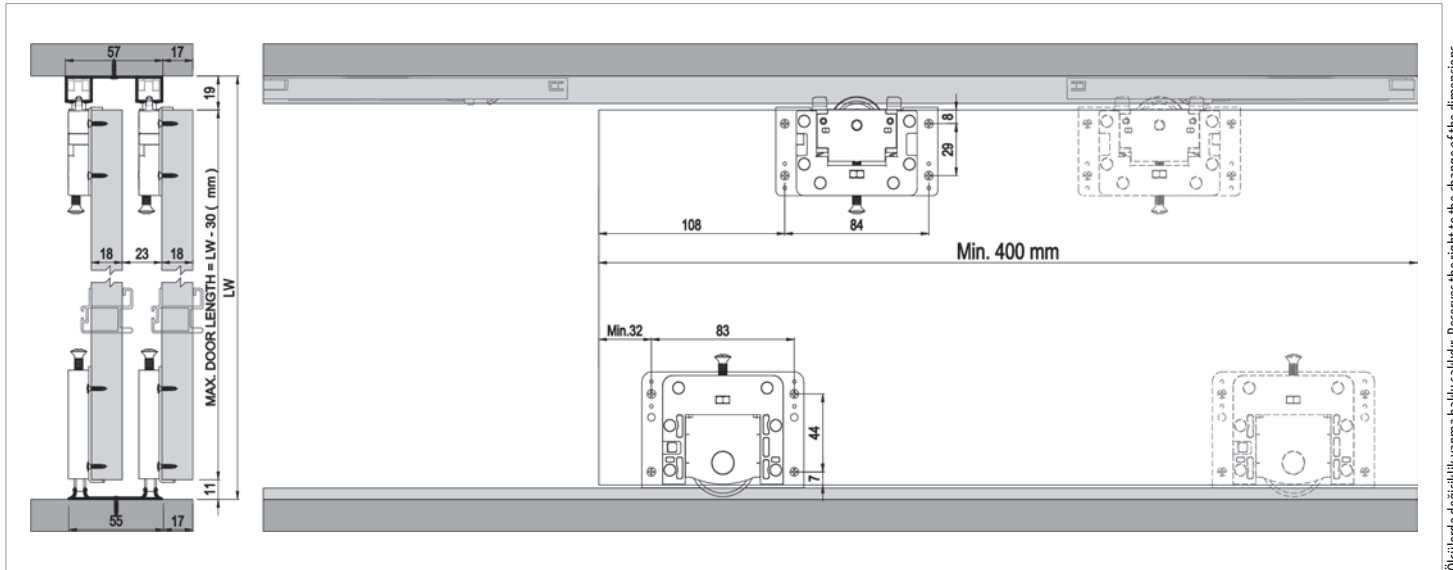

Ölçülerde değişiklik yapma hakkı saklıdır. Reserves the right to the change of the dimensions.

Kod / Code No	Açıklama / Description	Renk / Colour	Birim / Unit			Profil mt. / Profiles mt.	Bağ / Bnd.
103-1120-1200	Multiline 12 - Sürme Gardrop Sistemi / Sliding Wardrobe System	Silver	2 Kapak / 1 Set	12	360	- - -	-
145-1811-1600	Kıl Fital / Ec-Wf Hair Wick	Gri / Grey	mt.	300	7.200	- - -	-
150-3250-1440	Alüminyum Alt-Üst Ray Profili / Aluminium Bottom-Top Rail Profile	Bronz Parlak / Bronze Bright	mt.	-	-	- - 3,0	4 ad/pcs
150-3255-1420	Alüminyum Üst Ray Profili / Aluminium Top Rail Profile	Parlak / Bright	mt.	-	-	- - 3,0	12 ad/pcs
150-7108-1420	Alüminyum Alt Ray Profili / Aluminium Bottom Rail Profile	Parlak / Bright	mt.	-	-	- - 3,0	12 ad/pcs
150-7520-1410	Alüminyum Alt Ray Profili / Aluminium Bottom Rail Profile	Eloksal / Mat Anodized	mt.	-	-	- - 3,0	30 ad/pcs
150-2900-1420	Alüminyum Kulp Profili / Aluminium Handle Profile	Parlak / Bright	mt.	-	-	2,0 2,5 3,0	6 ad/pcs
150-2940-1420	Alüminyum Orta Kayıt / Aluminium Horizontal Central	Parlak / Bright	mt.	-	-	- - 3,0	10 ad/pcs
150-1420-1420	Alüminyum Kapama Profili / Aluminium Closure Profile	Parlak / Bright	mt.	-	-	- - 3,0	10 ad/pcs
150-2930-1420	Alüminyum Orta Kayıt / Aluminium Horizontal Central	Parlak / Bright	mt.	-	-	- - 3,0	10 ad/pcs

Multiline 13

103-1130

50 KG AYARLI SÜRME KAPAK SİSTEMİ
50 KG ADJUSTABLE SLIDING DOOR SYSTEM

Yeni Ürün
New Product



Bilgi / Information

- 1 Kutu İçeriği : 2 Kapak Mekanizma + 4 Ad Yavaşlatıcı
- In 1 box : 2 Door Mechanism + 4 Pcs Soft Closers



103-1130 1 Set İçeriği / 1 Set Includes



103-1121-1200



103-1122-1200

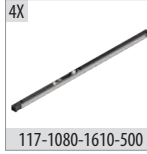

117-1080-1610-500

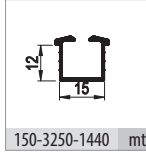

150-3250-1440 mt

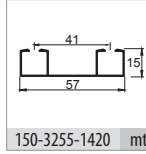

150-3255-1420 mt

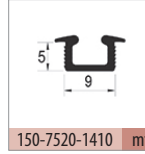

150-7520-1410 mt

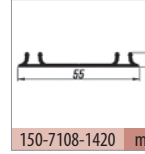

150-7108-1420 mt

Ray Profilleri / Rail Profiles

Kulp Profilleri / Handle Profiles

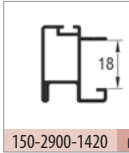

150-2900-1420 mt

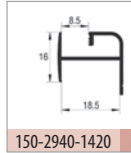

150-2940-1420 mt

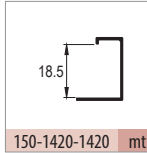

150-1420-1420 mt

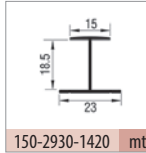

150-2930-1420 mt

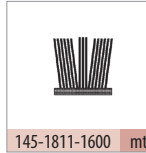

145-1811-1600 mt

Teknik Detay / Technical Detail

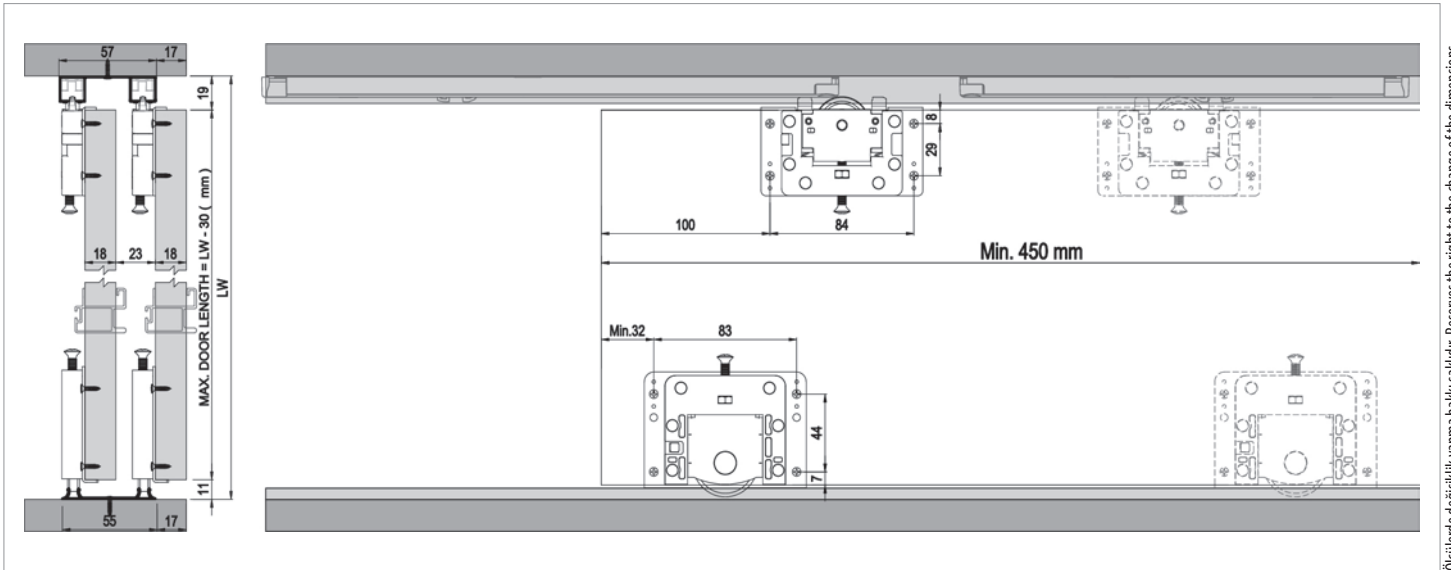

Ölçülerde değişiklik yapma hakkı saklıdır. Reserves the right to the change of the dimensions.

Kod / Code No	Açıklama / Description	Renk / Colour	Birim / Unit			Profil mt. / Profiles mt.	Bağ / Bnd.
103-1130-1200	Multiline 13 - Sürme Gardrop Sistemi / Sliding Wardrobe System	Silver	2 Kapak / 1 Set	12	360	- - -	-
145-1811-1600	Kıl Fital / Ec-Wf Hair Wick	Gri / Grey	mt.	300	7.200	- - -	-
150-3250-1440	Alüminyum Alt-Üst Ray Profili / Aluminium Bottom-Top Rail Profile	Bronz Parlak / Bronze Bright	mt.	-	-	- - 3,0	4 ad/pcs
150-3255-1420	Alüminyum Üst Ray Profili / Aluminium Top Rail Profile	Parlak / Bright	mt.	-	-	- - 3,0	12 ad/pcs
150-7108-1420	Alüminyum Alt Ray Profili / Aluminium Bottom Rail Profile	Parlak / Bright	mt.	-	-	- - 3,0	12 ad/pcs
150-7520-1410	Alüminyum Alt Ray Profili / Aluminium Bottom Rail Profile	Eloksal / Mat Anodized	mt.	-	-	- - 3,0	30 ad/pcs
150-2900-1420	Alüminyum Kulp Profili / Aluminium Handle Profile	Parlak / Bright	mt.	-	-	2,0 2,5 3,0	6 ad/pcs
150-2940-1420	Alüminyum Orta Kayıt / Aluminium Horizontal Central	Parlak / Bright	mt.	-	-	- - 3,0	10 ad/pcs
150-1420-1420	Alüminyum Kapama Profili / Aluminium Closure Profile	Parlak / Bright	mt.	-	-	- - 3,0	10 ad/pcs
150-2930-1420	Alüminyum Orta Kayıt / Aluminium Horizontal Central	Parlak / Bright	mt.	-	-	- - 3,0	10 ad/pcs

Multiline 14

103-1140

15 KG AYARLI SÜRME KAPAK SİSTEMİ
15 KG ADJUSTABLE SLIDING DOOR SYSTEM

Yeni Ürün
New Product

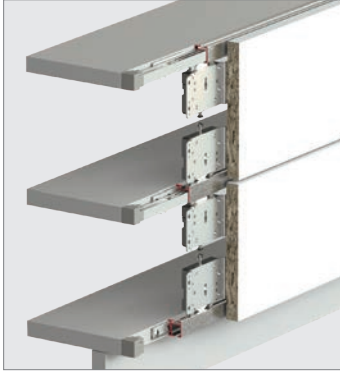

Bilgi / Information

- 1 Kutu İçeriği : 1 Kapak Mekanizma + 2 Ad Yavaşlatıcı
- In 1 box : 1 Door Mechanism + 2 Pcs Soft Closers



103-1140 1 Takım İçeriği / 1 Kit Includes

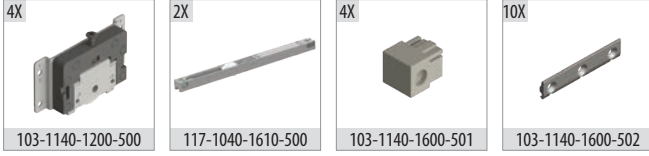

Ray Profilleri / Rail Profiles

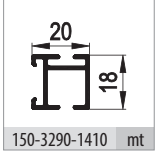

Teknik Detay / Technical Detail

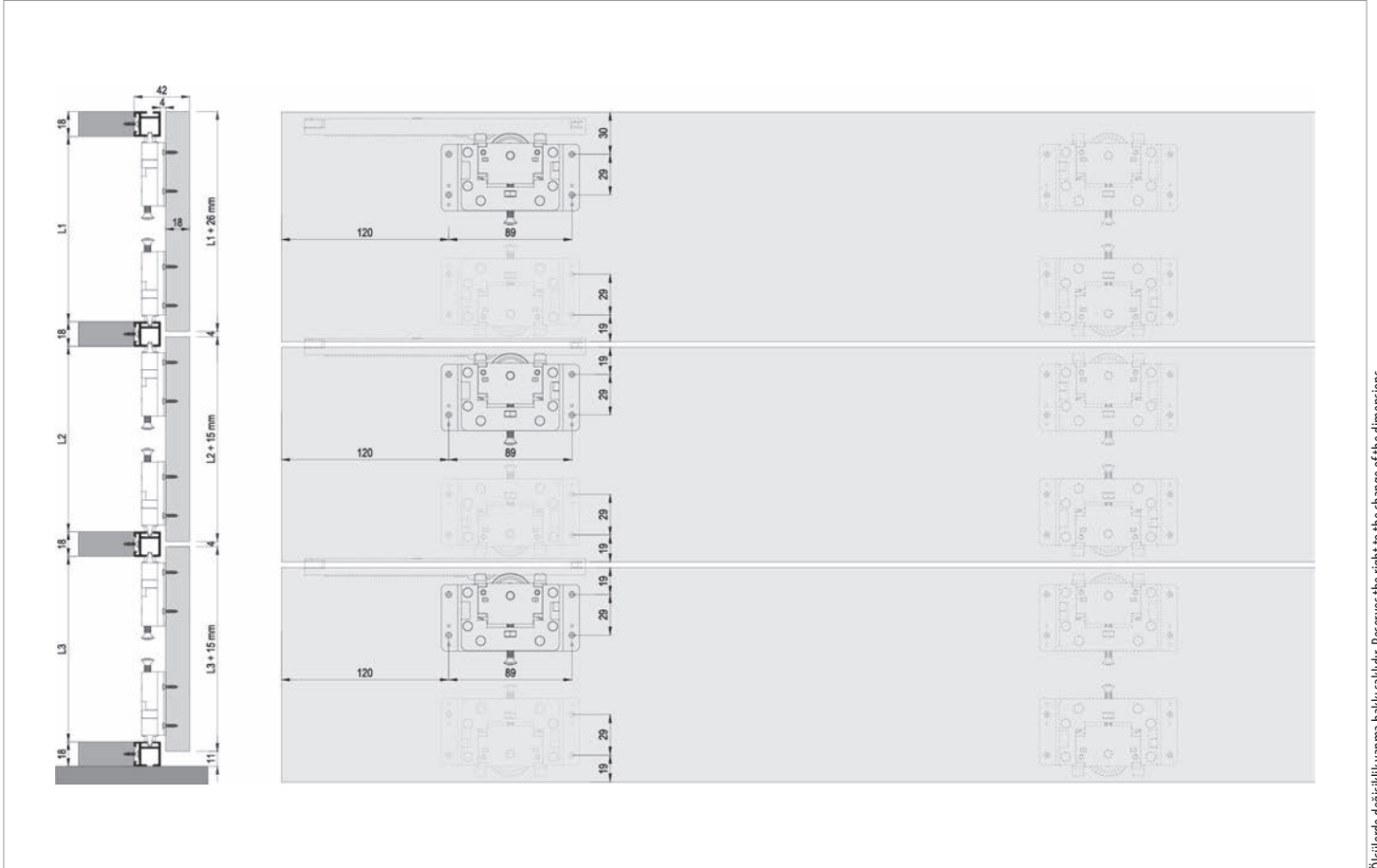



Ölçülerde değişiklik yapma hakkı saklıdır. Reserves the right to the change of the dimensions.

Kod / Code No	Açıklama / Description	Renk / Colour	Birim / Unit			Profil mt. / Profiles mt.	Bağ / Bnd.
103-1140-1200	Multiline 14 - Sürme Gardırop Sistemi / Sliding Wardrobe System	Silver	1 Kapak / 1 Kit	12	360	- - -	-
150-3290-1410	Alüminyum Alt-Üst Ray Profili / Aluminium Bottom-Top Rail Profile	Eloksal / Mat Anodized	mt.	-	-	- - 3,0	6 ad/pcs



Multiline 14

<p>SINCE 1976</p>	 <p>Bearing Systems</p>	<p>EN 1527 100.000 CYCLES TEST</p> 	<p>R</p> <p>The Sliding System</p>
-----------------------	--	--	---



Multiline 15

103-1150

50 KG AYARLI SÜRME KAPAK SİSTEMİ
50 KG ADJUSTABLE SLIDING DOOR SYSTEM

Yeni Ürün
New Product

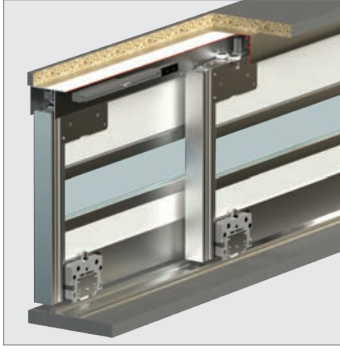

Bilgi / Information

- 1 Kutu İçeriği : 2 Kapak Mekanizma + 4 Ad Yavaşlatıcı
- In 1 box : 2 Door Mechanism + 4 Pcs Soft Closers

- 3 Kapaklı Dolap Uygulaması
- 3 Doors Wardrobe Application



103-1150 1 Set İçeriği / 1 Set Includes

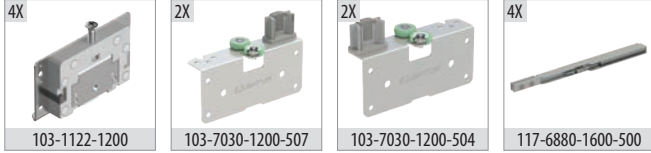

103-1151 Opsiyonel 3. İç Kapak / Optional 3. Internal Door

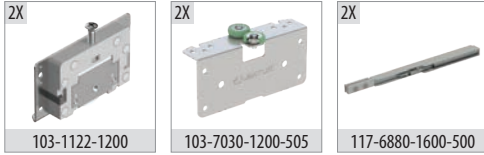

Ray Profilleri / Rail Profiles

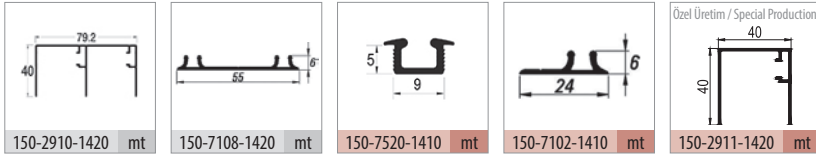

Kulp Profilleri / Handle Profiles

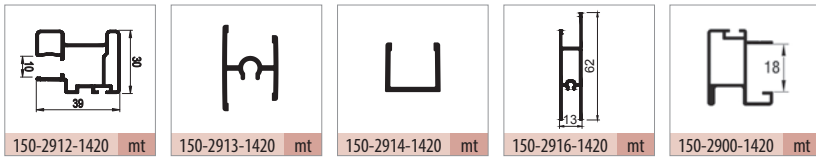

Opsiyonel Aksesuar / Optional Accessories

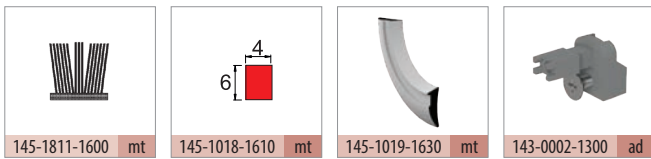

Teknik Detay / Technical Detail

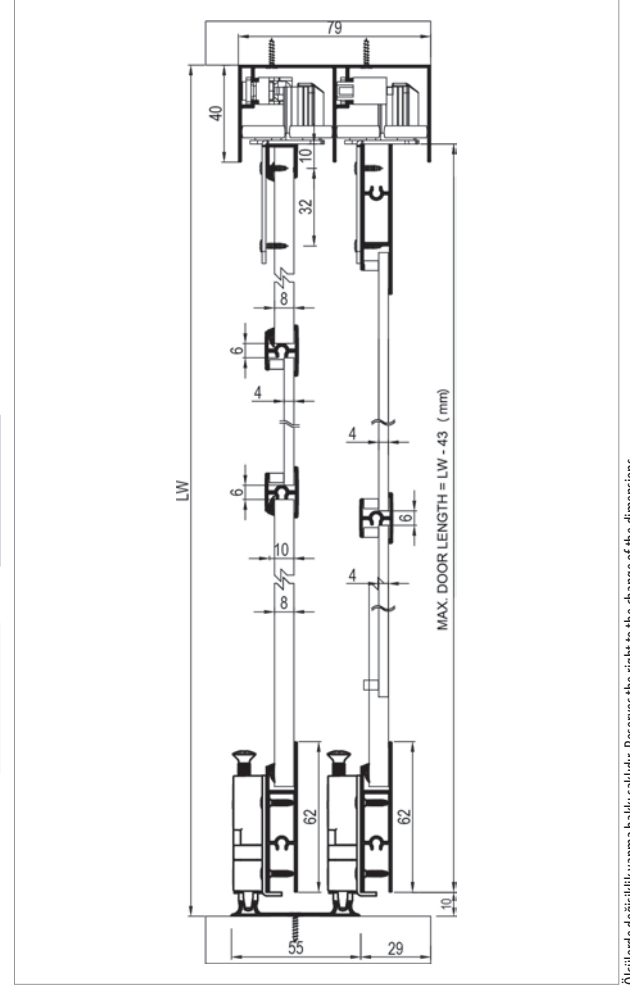

Ölçülerde değişiklik yapma hakkı saklıdır. Reserves the right to the change of the dimensions.

Kod / Code No	Açıklama / Description	Renk / Colour	Birim / Unit			Profil mt. / Profiles mt.	Bağ / Bnd.
103-1150-1200	Multiline 15 - Sürme Kapak Sistemi / Sliding Door System	Silver	2 Kapak / 1 Set	12	360	- - -	-
103-1151-1200	Multiline 15 - Sürme Kapak Sistemi 3. Kapak / Sliding Door System 3. Door	Silver	1 Kapak / 1 Kit	8	400	- - -	-
143-0002-1300	Bağlantı Kiti / Connection Kit	Silver	1 Adet / 1 Pcs	-	-	- - -	-
145-1018-1610	Cam Adaptör Fitolü / Glass Adapter Wick	Şeffaf / Transparan	mt.	100	3.600	- - -	-
145-1019-1630	8 mm Panel Adaptör Fitolü / 8 mm Panel Adapter Wick	Siyah / Black	mt.	100	3.600	- - -	-
145-1811-1600	Kıl Fitolü / Ec-Wf Hair Wick	Gri / Grey	mt.	300	7.200	- - -	-
150-2910-1420	Alüminyum Üst Ray Profili / Aluminium Top Rail Profile	Parlak / Bright	mt.	-	-	2,0 2,5 3,0	6 ad/pcs
150-7108-1420	Alüminyum Alt Ray Profili / Aluminium Bottom Rail Profile	Parlak / Bright	mt.	-	-	2,0 2,5 3,0	12 ad/pcs
150-2912-1420	Alüminyum Kulp Profili / Aluminium Handle Profile	Parlak / Bright	mt.	-	-	2,0 - 3,0	4 ad/pcs
150-2913-1420	Alüminyum Orta Kayıt / Aluminium Horizontal Central	Parlak / Bright	mt.	-	-	- 3,0	10 ad/pcs
150-2914-1420	Alüminyum Kapama Profili / Aluminium Closure Profile	Parlak / Bright	mt.	-	-	- 3,0	24 ad/pcs
150-2916-1420	Alüminyum Çerçeve Profili / Aluminium Frame Profile	Parlak / Bright	mt.	-	-	- 3,0	4 ad/pcs



Bilgi / Information

- 1 Kutu İçeriği : 2 Kapak Mekanizma + 4 Ad Yavaşlatıcı
- In 1 box : 2 Door Mechanism + 4 Pcs Soft Closers



103-1160 1 Set İçeriği / 1 Set Includes

Ray Profilleri / Rail Profiles

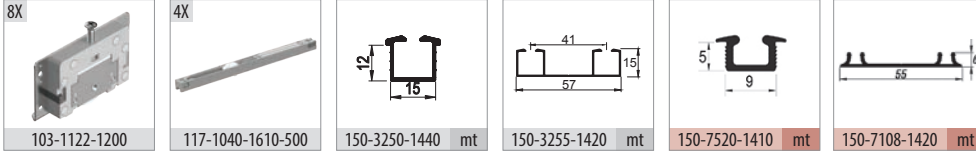

Kulp Profilleri / Handle Profiles

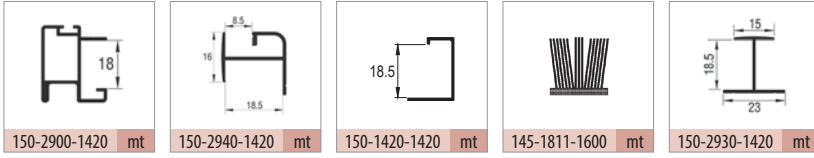

Teknik Detay / Technical Detail

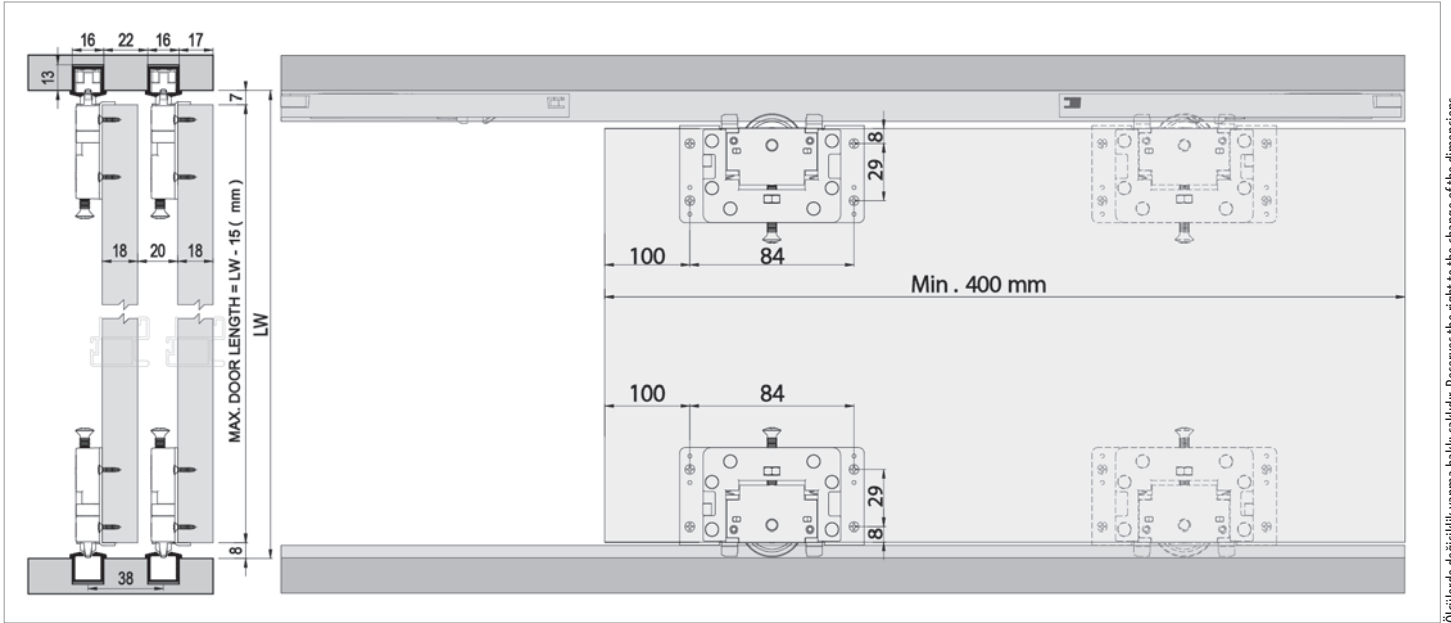

Ölçülerde değişiklik yapma hakkı saklıdır. Reserves the right to the change of the dimensions.

Kod / Code No	Açıklama / Description	Renk / Colour	Birim / Unit			Profil mt. / Profiles mt.	Bağ / Bnd.
103-1160-1200	Multiline 16 - Sürme Gardirop Sistemi / Sliding Wardrobe System	Silver	2 Kapak / 1 Set	12	360	- - -	-
145-1811-1600	Kil Fital / Ec-Wf Hair Wick	Gri / Grey	mt.	300	7.200	- - -	-
150-3250-1440	Alüminyum Alt-Üst Ray Profili / Aluminium Bottom-Top Rail Profile	Bronz Parlak / Bronze Bright	mt.	-	-	- - 3,0	4 ad/pcs
150-3255-1420	Alüminyum Üst Ray Profili / Aluminium Top Rail Profile	Parlak / Bright	mt.	-	-	- - 3,0	12 ad/pcs
150-7108-1420	Alüminyum Alt Ray Profili / Aluminium Bottom Rail Profile	Parlak / Bright	mt.	-	-	- - 3,0	12 ad/pcs
150-7520-1410	Alüminyum Alt Ray Profili / Aluminium Bottom Rail Profile	Eloksal / Mat Anodized	mt.	-	-	- - 3,0	30 ad/pcs
150-2900-1420	Alüminyum Kulp Profili / Aluminium Handle Profile	Parlak / Bright	mt.	-	-	2,0 2,5 3,0	6 ad/pcs
150-2940-1420	Alüminyum Orta Kayıt / Aluminium Horizontal Central	Parlak / Bright	mt.	-	-	- - 3,0	10 ad/pcs
150-1420-1420	Alüminyum Kapama Profili / Aluminium Closure Profile	Parlak / Bright	mt.	-	-	- - 3,0	10 ad/pcs
150-2930-1420	Alüminyum Orta Kayıt / Aluminium Horizontal Central	Parlak / Bright	mt.	-	-	- - 3,0	10 ad/pcs

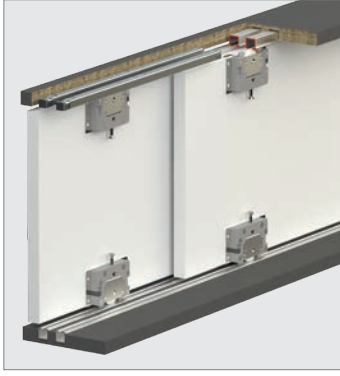

Bilgi / Information

- 1 Kutu İçeriği : 2 Kapak Mekanizma + 4 Ad Yavaşlatıcı
- In 1 box : 2 Door Mechanism + 4 Pcs Soft Closers



103-1170 1 Set İçeriği / 1 Set Includes

Ray Profilleri / Rail Profiles

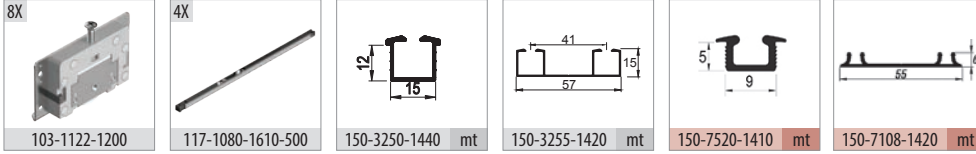

Kulp Profilleri / Handle Profiles

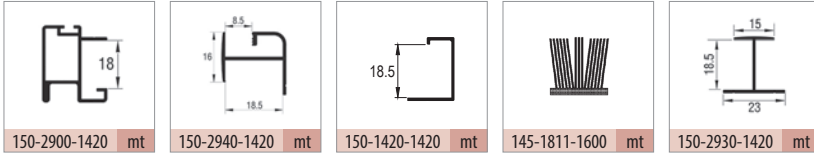

Teknik Detay / Technical Detail

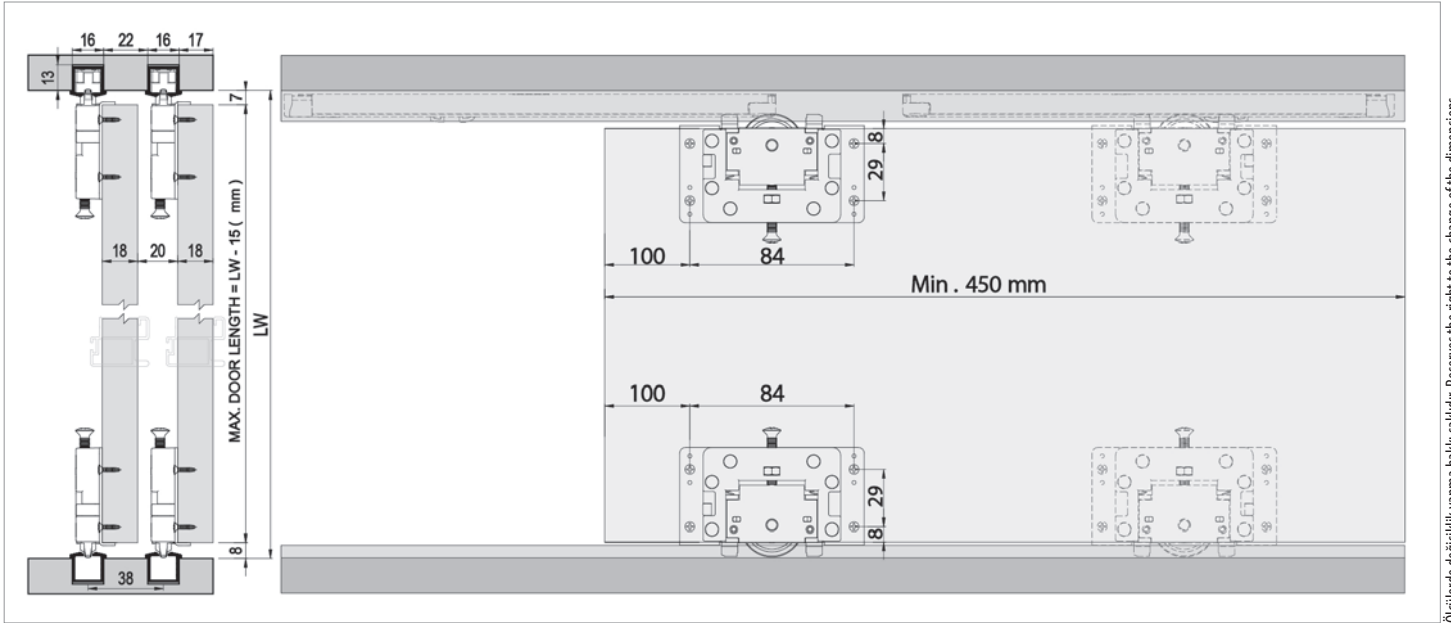

Ölçülerde değişiklik yapma hakkı saklıdır. Reserves the right to the change of the dimensions.

Kod / Code No	Açıklama / Description	Renk / Colour	Birim / Unit			Profil mt. / Profiles mt.			Bağ / Bnd.
103-1170-1200	Multiline 17 - Sürme Gardrop Sistemi / Sliding Wardrobe System	Silver	2 Kapak / 1 Set	12	360	-	-	-	-
145-1811-1600	Kil Fital / Ec-Wf Hair Wick	Gri / Grey	mt.	300	7.200	-	-	-	-
150-3250-1440	Alüminyum Alt-Üst Ray Profili / Aluminium Bottom-Top Rail Profile	Bronz Parlak / Bronze Bright	mt.	-	-	-	-	3,0	4 ad/pcs
150-3255-1420	Alüminyum Üst Ray Profili / Aluminium Top Rail Profile	Parlak / Bright	mt.	-	-	-	-	3,0	12 ad/pcs
150-7108-1420	Alüminyum Alt Ray Profili / Aluminium Bottom Rail Profile	Parlak / Bright	mt.	-	-	-	-	3,0	12 ad/pcs
150-7520-1410	Alüminyum Alt Ray Profili / Aluminium Bottom Rail Profile	Eloksal / Mat Anodized	mt.	-	-	-	-	3,0	30 ad/pcs
150-2900-1420	Alüminyum Kulp Profili / Aluminium Handle Profile	Parlak / Bright	mt.	-	-	2,0	2,5	3,0	6 ad/pcs
150-2940-1420	Alüminyum Orta Kayıt / Aluminium Horizontal Central	Parlak / Bright	mt.	-	-	-	-	3,0	10 ad/pcs
150-1420-1420	Alüminyum Kapama Profili / Aluminium Closure Profile	Parlak / Bright	mt.	-	-	-	-	3,0	10 ad/pcs
150-2930-1420	Alüminyum Orta Kayıt / Aluminium Horizontal Central	Parlak / Bright	mt.	-	-	-	-	3,0	10 ad/pcs



Bilgi / Information

- 1 Kutu İçeriği : 2 Kapak Mekanizma + 4 Ad Yavaşlatıcı
- In 1 box : 2 Door Mechanism + 4 Pcs Soft Closers



103-1180 1 Set İçeriği / 1 Set Includes

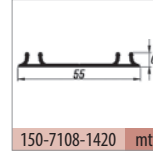
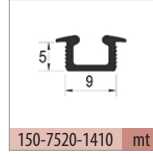
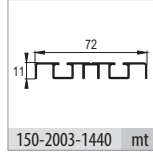
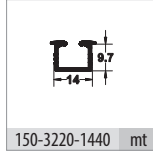
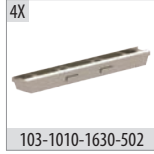
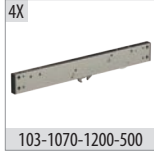
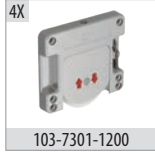

Ray Profilleri / Rail Profiles

Kulp Profilleri / Handle Profiles

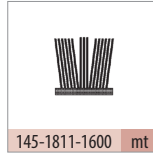
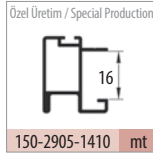
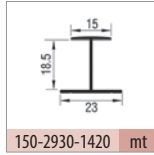
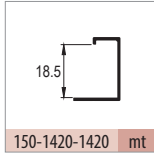
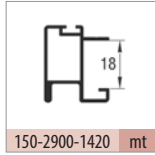

Teknik Detay / Technical Detail

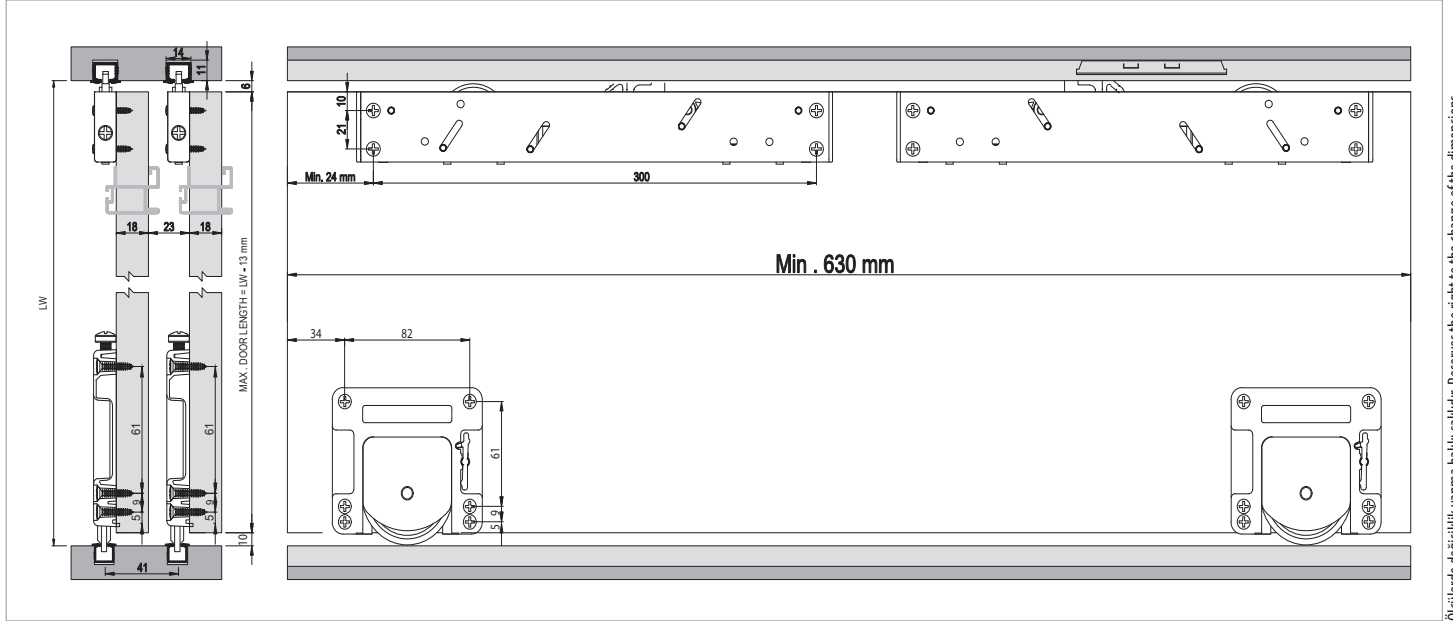

Ölçülerde değişiklik yapma hakkı saklıdır. Reserves the right to the change of the dimensions.

Kod / Code No	Açıklama / Description	Renk / Colour	Birim / Unit			Profil mt. / Profiles mt.	Bağ / Bnd.
103-1180-1200	Multiline 18 - Sürme Gardrop Sistemi / Sliding Wardrobe System	Silver	2 Kapak / 1 Set	12	360	- - -	-
145-1811-1600	Kıl Fital / Ec-Wf Hair Wick	Gri / Grey	mt.	300	7.200	- - -	-
150-3220-1440	Alüminyum Alt-Üst Ray Profili / Aluminium Bottom-Top Rail Profile	Bronz Parlak / Bronze Bright	mt.	-	-	- - 3,0	4 ad/pcs
150-2003-1440	Alüminyum Üst Ray Profili / Aluminium Top Rail Profile	Bronz Parlak / Bronze Bright	mt.	-	-	- - 3,0	12 ad/pcs
150-7108-1420	Alüminyum Alt Ray Profili / Aluminium Bottom Rail Profile	Parlak / Bright	mt.	-	-	- - 3,0	12 ad/pcs
150-7520-1410	Alüminyum Alt Ray Profili / Aluminium Bottom Rail Profile	Eloksal / Mat Anodized	mt.	-	-	- - 3,0	30 ad/pcs
150-2900-1420	Alüminyum Kulp Profili / Aluminium Handle Profile	Parlak / Bright	mt.	-	-	2,0 2,5 3,0	6 ad/pcs
150-2500-1410	Alüminyum Orta Kayıt / Aluminium Horizontal Central	Parlak / Bright	mt.	-	-	- - 3,0	10 ad/pcs
150-1420-1420	Alüminyum Kapama Profili / Aluminium Closure Profile	Parlak / Bright	mt.	-	-	- - 3,0	10 ad/pcs
150-2930-1420	Alüminyum Orta Kayıt / Aluminium Horizontal Central	Parlak / Bright	mt.	-	-	- - 3,0	10 ad/pcs

Multiline SRG 100

103-0100

60 KG AYARLI SÜRME KAPAK SİSTEMİ
60 KG ADJUSTABLE SLIDING DOOR SYSTEM

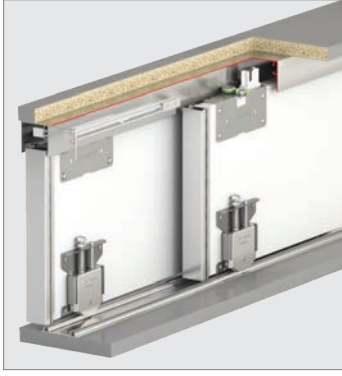

Bilgi / Information

- 1 Kutu İçeriği : 2 Kapak Mekanizma + 4 Ad Yavaşlatıcı
- In 1 box : 2 Door Mechanism + 4 Pcs Soft Closers

- 3 Kapaklı Dolap Uygulaması
- 3 Doors Wardrobe Application



103-0100 1 Set İçeriği / 1 Set Includes

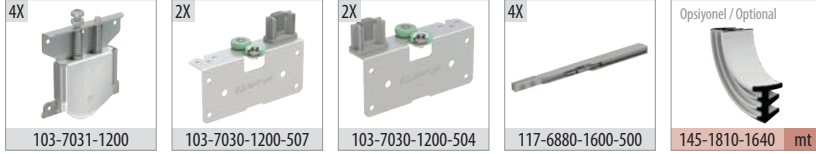

103-0103 Opsiyonel 3. İç Kapak / Optional 3. Internal Door

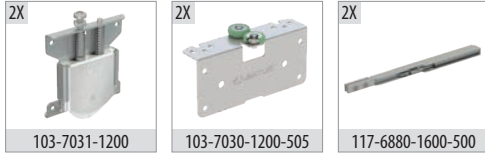

Ray Profilleri / Rail Profiles

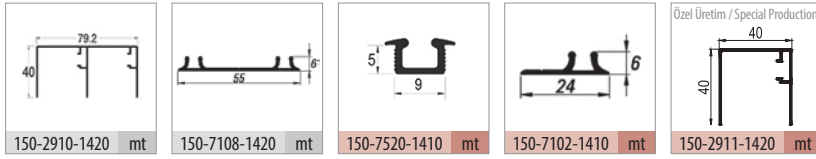

Kulp Profilleri / Handle Profiles

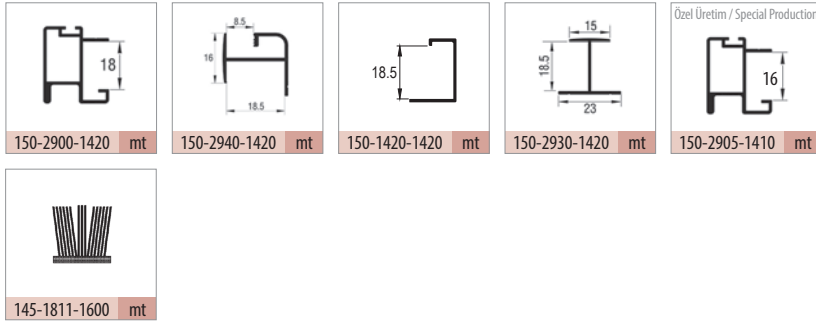

Teknik Detay / Technical Detail

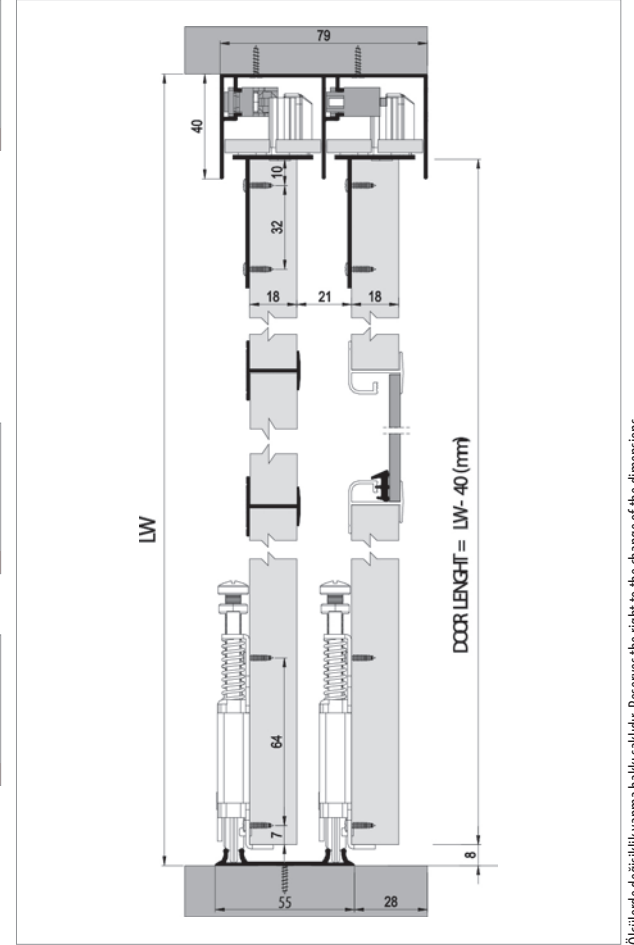

Ölçülerde değişiklik yapma hakkı saklıdır. Reserves the right to the change of the dimensions.

Kod / Code No	Açıklama / Description	Renk / Colour	Birim / Unit			Profil mt. / Profiles mt.	Bağ / Bnd.
103-0100-1200	SRG 100 - Sürme Kapak Sistemi / Sliding Door System	Silver	2 Kapak / 1 Set	12	360	- - -	-
103-0103-1200	SRG 100 C - Sürme Kapak Sistemi 3. Kapak / Sliding Wardrobe System 3. Door	Silver	1 Kapak / 1 Kit	8	400	- - -	-
145-1810-1640	Cam Fitolü / Glass Wick	Şeffaf / Transparan	mt.	100	3.600	- - -	-
150-2910-1420	Alüminyum Üst Ray Profili / Aluminium Top Rail Profile	Parlak / Bright	mt.	-	-	2,0 2,5 3,0	6 ad/pcs
150-7108-1420	Alüminyum Alt Ray Profili / Aluminium Bottom Rail Profile	Parlak / Bright	mt.	-	-	2,0 2,5 3,0	12 ad/pcs
150-2900-1420	Alüminyum Kulp Profili / Aluminium Handle Profile	Parlak / Bright	mt.	-	-	2,0 2,5 3,0	6 ad/pcs
150-2940-1420	Alüminyum Orta Kayıt / Aluminium Horizontal Central	Parlak / Bright	mt.	-	-	- - 3,0	10 ad/pcs
150-1420-1420	Alüminyum Kapama Profili / Aluminium Closure Profile	Parlak / Bright	mt.	-	-	- - 3,0	10 ad/pcs
150-2930-1420	Alüminyum Orta Kayıt / Aluminium Horizontal Central	Parlak / Bright	mt.	-	-	- - 3,0	10 ad/pcs

Multiline SRG 300

103-0300

70 KG AYARLI SÜRME KAPAK SİSTEMİ
70 KG ADJUSTABLE SLIDING DOOR SYSTEM

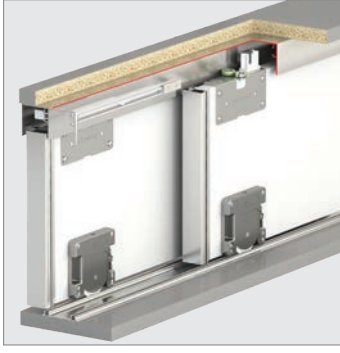

Bilgi / Information

- 1 Kutu İçeriği : 2 Kapak Mekanizma + 4 Ad Yavaşlatıcı
- In 1 box : 2 Doors Mechanism + 4 Pcs Soft Closers



103-0300 1 Set İçeriği / 1 Set Includes

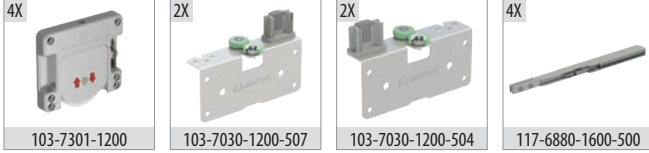

103-0303 Opsiyonel 3. İç Kapak / Optional 3. Internal Door

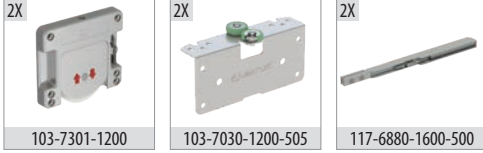

Ray Profilleri / Rail Profiles

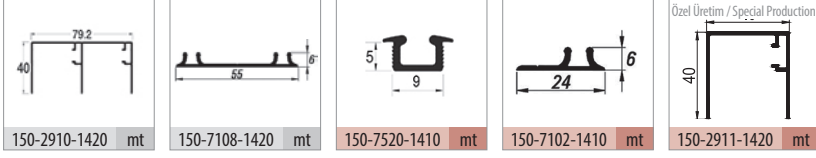

Kulp Profilleri / Handle Profiles

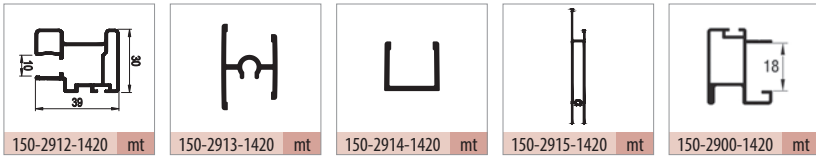

Opsiyonel Aksesuar / Optional Accessories

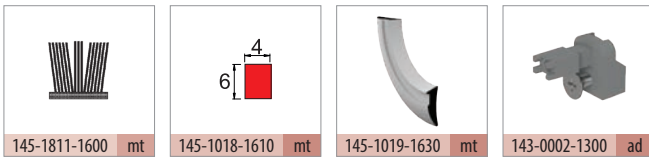

Teknik Detay / Technical Detail

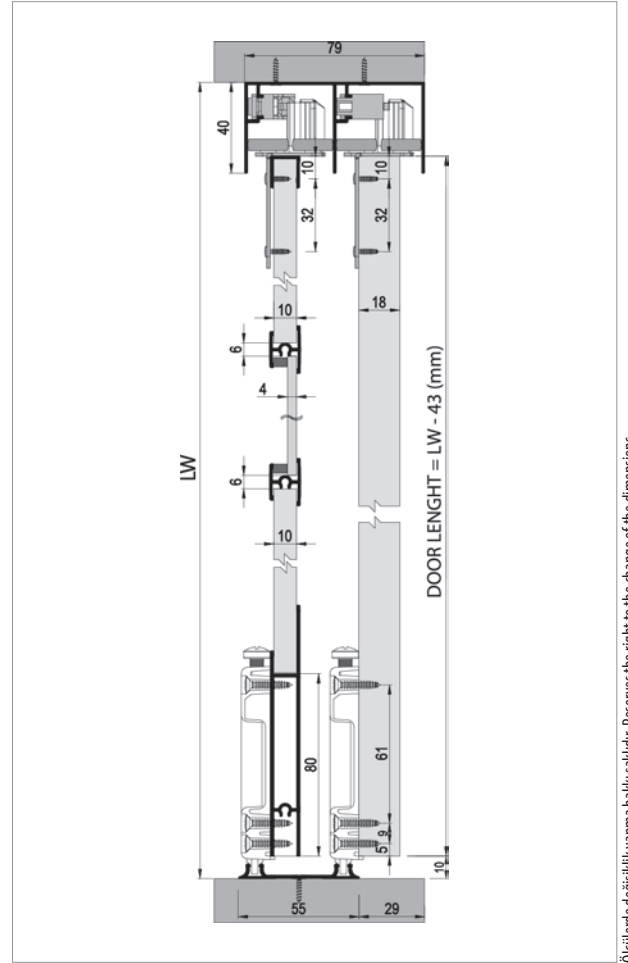

Ölçülerde değişiklik yapma hakkı saklıdır. Reserves the right to the change of the dimensions.

Kod / Code No	Açıklama / Description	Renk / Colour	Birim / Unit			Profil mt. / Profiles mt.	Bağ / Bnd.
103-0300-1200	SRG 300 - Sürme Kapak Sistemi / Sliding Door System	Silver	2 Kapak / 1 Set	12	360	- - -	-
103-0303-1200	SRG 300 C - Sürme Kapak Sistemi 3. Kapak / Sliding Door System 3. Door	Silver	1 Kapak / 1 Kit	8	400	- - -	-
143-0002-1300	Bağlantı Kiti / Connection Kit	Silver	1 Adet / 1 Pcs	-	-	- - -	-
145-1018-1610	Cam Adaptör Fitolü / Glass Adapter Wick	Şeffaf / Transparan	mt.	100	3.600	- - -	-
145-1019-1630	8 mm Panel Adaptör Fitolü / 8 mm Panel Adapter Wick	Siyah / Black	mt.	100	3.600	- - -	-
145-1811-1600	Kıl Fitolü / Ec-Wf Hair Wick	Gri / Grey	mt.	300	7.200	- - -	-
150-2910-1420	Alüminyum Üst Ray Profili / Aluminium Top Rail Profile	Parlak / Bright	mt.	-	-	2,0 2,5 3,0	6 ad/pcs
150-7108-1420	Alüminyum Alt Ray Profili / Aluminium Bottom Rail Profile	Parlak / Bright	mt.	-	-	2,0 2,5 3,0	12 ad/pcs
150-2912-1420	Alüminyum Kulp Profili / Aluminium Handle Profile	Parlak / Bright	mt.	-	-	- - 3,0	4 ad/pcs
150-2913-1420	Alüminyum Orta Kayıt / Aluminium Horizontal Central	Parlak / Bright	mt.	-	-	- - 3,0	10 ad/pcs
150-2914-1420	Alüminyum Kapama Profili / Aluminium Closure Profile	Parlak / Bright	mt.	-	-	- - 3,0	24 ad/pcs
150-2915-1420	Alüminyum Çerçeve Profili / Aluminium Frame Profile	Parlak / Bright	mt.	-	-	- - 3,0	4 ad/pcs

Multiline SRG 110

103-0110

70 KG AYARLI SÜRME KAPAK SİSTEMİ
70 KG ADJUSTABLE SLIDING DOOR SYSTEM

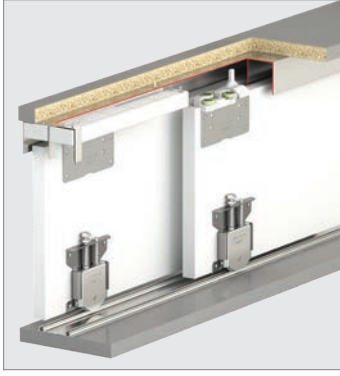

Bilgi / Information

- 1 Kutu İçeriği : 2 Kapak Mekanizma + 4 Ad Yavaşlatıcı
- In 1 box : 2 Doors Mechanism + 4 Pcs Soft Closers

- 3 Kapaklı Dolap Uygulaması
- 3 Doors Wardrobe Application



103-0110 1 Set İçeriği / 1 Set Includes

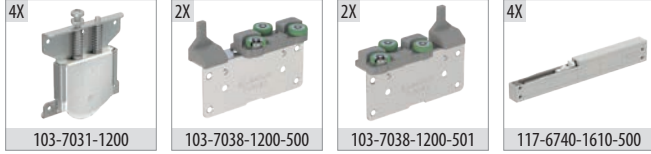

Ray Profilleri / Rail Profiles

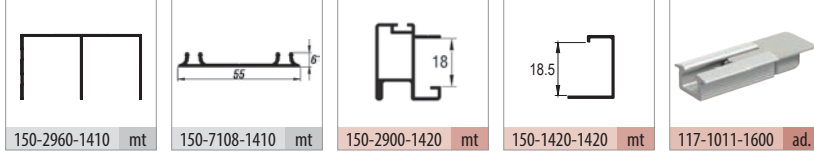

Kulp Profilleri / Handle Profiles



Teknik Detay / Technical Detail

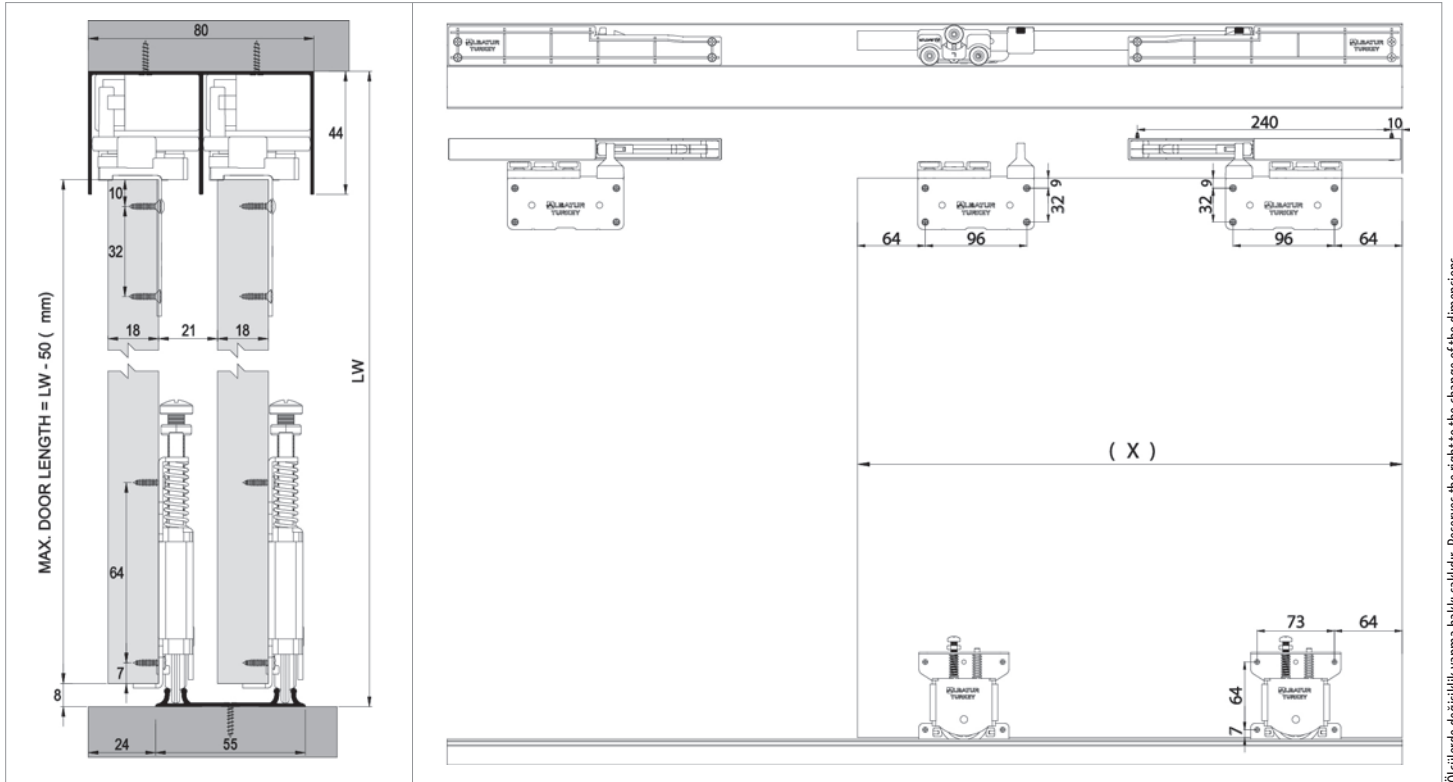

Ölçülerde değişiklik yapma hakkı saklıdır. Reserves the right to the change of the dimensions.

Kod / Code No	Açıklama / Description	Renk / Colour	Birim / Unit			Profil mt. / Profiles mt.	Bağ / Bnd.
103-0110-1200	SRG 110 - Sürme Kapak Sistemi / Sliding Door System	Silver	2 Kapak / 1 Set	12	216	- - -	-
117-1011-1600	Plastik Ray Tapası / Plastic Rail Cap	Gri / Grey	1 Adet / 1 Pcs	1.000	120.000	- - -	-
150-2960-1410	Alüminyum Üst Ray Profili / Aluminium Top Rail Profile	Eloksal / Mat Anodized	mt.	-	-	2,0 2,5 3,0	6 ad/pcs
150-7108-1410	Alüminyum Alt Ray Profili / Aluminium Bottom Rail Profile	Eloksal / Mat Anodized	mt.	-	-	2,0 2,5 3,0	12 ad/pcs
150-2900-1420	Alüminyum Kulp Profili / Aluminium Handle Profile	Parlak / Bright	mt.	-	-	2,0 2,5 3,0	6 ad/pcs
150-1420-1420	Alüminyum Kapama Profili / Aluminium Closure Profile	Parlak / Bright	mt.	-	-	- - 3,0	10 ad/pcs

Multiline SRG 115

103-0115

70 KG AYARLI SÜRME KAPAK SİSTEMİ
70 KG ADJUSTABLE SLIDING DOOR SYSTEM

Özel Üretim
Special Production

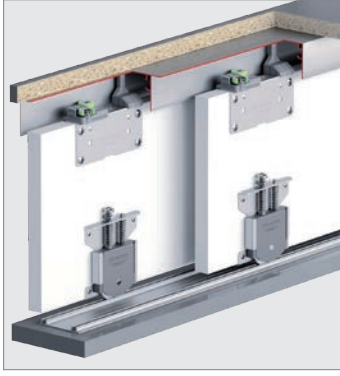

Bilgi / Information

- 1 Kutu İçeriği : 2 Kapak Mekanizma + 4 Ad Yavaşlatıcı
- In 1 box : 2 Door Mechanism + 4 Pcs Soft Closers

- 3 Kapaklı Dolap Uygulaması
- 3 Doors Wardrobe Application

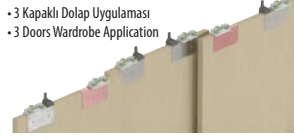

103-0115 1 Set İçeriği / 1 Set Includes

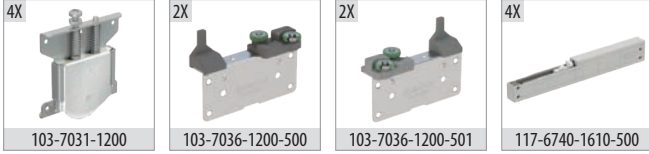

Ray Profilleri / Rail Profiles

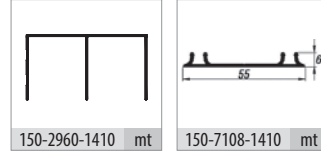

Kulp Profilleri / Handle Profiles

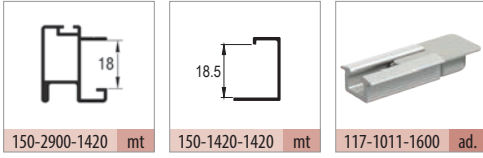

Teknik Detay / Technical Detail

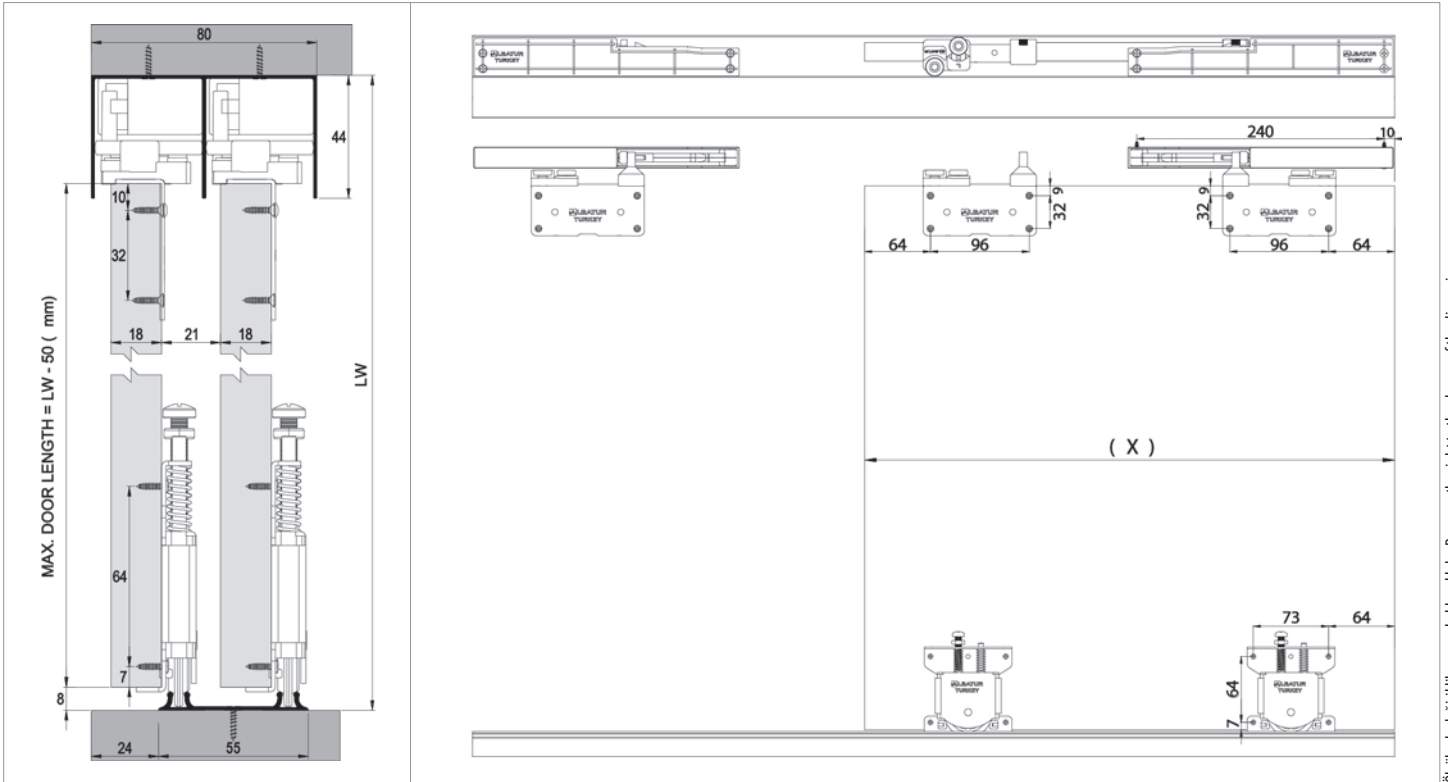

Ölçülerde değişiklik yapma hakkı saklıdır. Reserves the right to the change of the dimensions.

Kod / Code No	Açıklama / Description	Renk / Colour	Birim / Unit			Profil mt. / Profiles mt.			Bağ / Bnd.
103-0115-1200	Multiline SRG 115 - 70 Kg Sürme Kapak Sistemi / Sliding Door System	Silver	2 Kapak / 1 Set	12	216	-	-	-	-
117-1011-1600	Plastik Ray Tapası / Plastic Rail Cap	Gri / Grey	1 Adet / 1 Pcs	1.000	120.000	-	-	-	-
150-2960-1410	Alüminyum Üst Ray Profili / Aluminium Top Rail Profile	Eloksal / Mat Anodized	mt.	-	-	2,0	2,5	3,0	6 ad/pcs
150-7108-1410	Alüminyum Alt Ray Profili / Aluminium Bottom Rail Profile	Eloksal / Mat Anodized	mt.	-	-	2,0	2,5	3,0	12 ad/pcs
150-2900-1420	Alüminyum Kulp Profili / Aluminium Handle Profile	Parlak / Bright	mt.	-	-	-	2,5	-	6 ad/pcs
150-1420-1420	Alüminyum Kapama Profili / Aluminium Closure Profile	Parlak / Bright	mt.	-	-	-	-	3,0	10 ad/pcs

Multiline SRG 210

103-0210

80 KG AYARLI SÜRME KAPAK SİSTEMİ
80 KG ADJUSTABLE SLIDING DOOR SYSTEM

Özel Üretim
Special Production

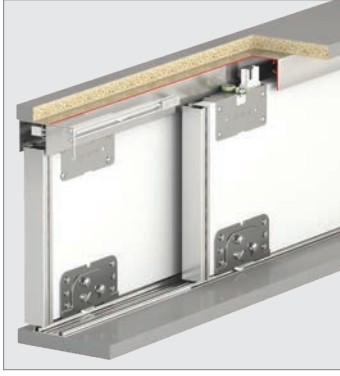

Bilgi / Information

- 1 Kutu İçeriği : 2 Kapak Mekanizma + 4 Ad Yavaşlatıcı
- In 1 box : 2 Doors Mechanism + 4 Pcs Soft Closers

- 3 Kapaklı Dolap Uygulaması
- 3 Doors Wardrobe Application



103-0210 1 Set İçeriği / 1 Set Includes

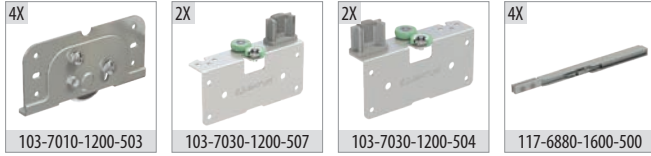

103-0213 Opsiyonel 3. İç Kapak / Optional 3. Internal Door

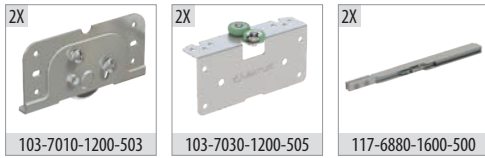

Ray Profilleri / Rail Profiles

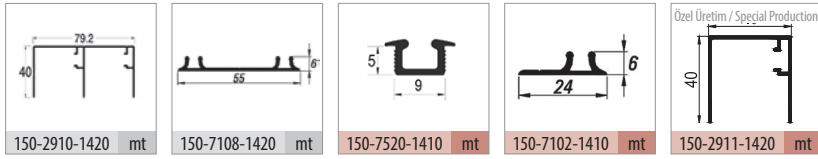

Kulp Profilleri / Handle Profiles

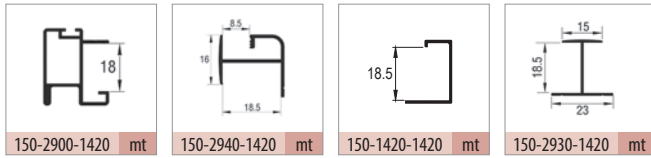

Opsiyonel Aksesuar / Optional Accessories

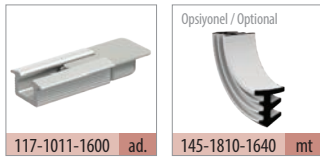

Teknik Detay / Technical Detail

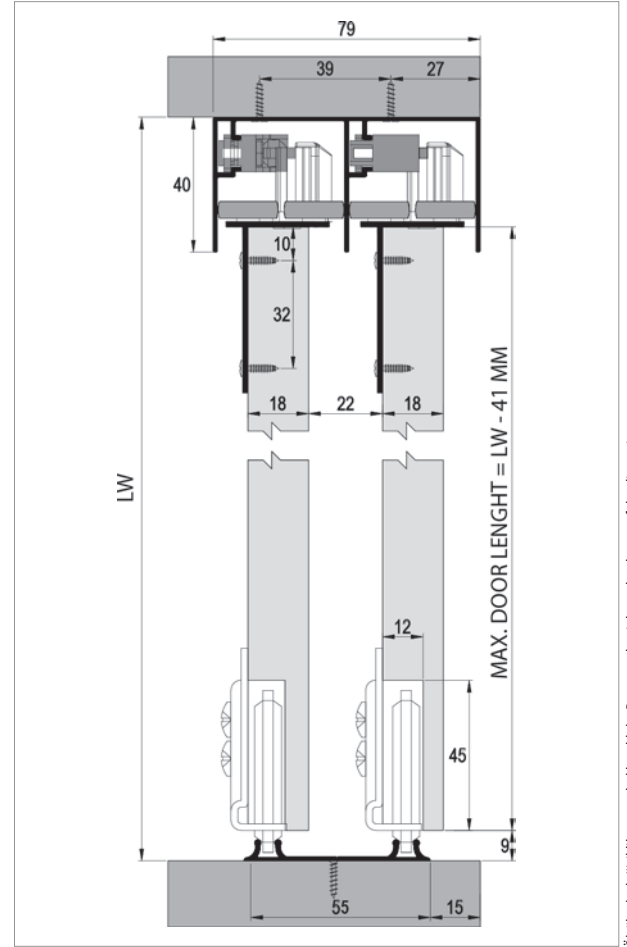



Ölçülerde değişiklik yapma hakkı saklıdır. Reserves the right to the change of the dimensions.

Kod / Code No	Açıklama / Description	Renk / Colour	Birim / Unit			Profil mt. / Profiles mt.	Bağ / Bnd.
103-0210-1200	SRG 210 - Sürme Kapak Sistemi / Sliding Door System	Silver	2 Kapak / 1 Set	12	360	- - -	-
103-0213-1200	SRG 210 C - Sürme Kapak Sistemi 3. Kapak / Sliding Door System 3. Door	Silver	1 Kapak / 1 Kit	12	360	- - -	-
145-1810-1640	Cam Fitolü / Glass Wick	Şeffaf / Transparan	mt.	100	3.600	- - -	-
150-2910-1420	Alüminyum Üst Ray Profili / Aluminium Top Rail Profile	Parlak / Bright	mt.	-	-	2,0 2,5 3,0	6 ad/pcs
150-7108-1420	Alüminyum Alt Ray Profili / Aluminium Bottom Rail Profile	Parlak / Bright	mt.	-	-	2,0 2,5 3,0	12 ad/pcs
150-2900-1420	Alüminyum Kulp Profili / Aluminium Handle Profile	Parlak / Bright	mt.	-	-	2,0 2,5 3,0	6 ad/pcs
150-2940-1420	Alüminyum Orta Kayıt / Aluminium Horizontal Central	Parlak / Bright	mt.	-	-	- - 3,0	10 ad/pcs
150-1420-1420	Alüminyum Kapama Profili / Aluminium Closure Profile	Parlak / Bright	mt.	-	-	- - 3,0	10 ad/pcs
150-2930-1420	Alüminyum Orta Kayıt / Aluminium Horizontal Central	Parlak / Bright	mt.	-	-	- - 3,0	10 ad/pcs



Multiline 7

<p>SINCE 1976</p>	 <p>Bearing Systems</p>	<p>EN 1527 100.000 CYCLES TEST</p> 	<p>R</p> <p>The Sliding System</p>
-----------------------	---	--	---



Multiline SRG 120

103-0120

80 KG AYARLI SÜRME KAPAK SİSTEMİ
80 KG ADJUSTABLE SLIDING DOOR SYSTEM

Özel Üretim
Special Production

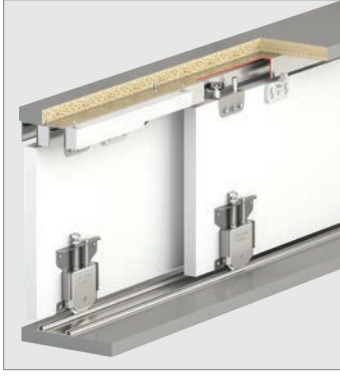

Bilgi / Information

- 1 Kutu İçeriği : 2 Kapak Mekanizma + 4 Ad Yavaşlatıcı
- In 1 box : 2 Doors Mechanism + 4 Pcs Soft Closers



103-0120 1 Set İçeriği / 1 Set Includes

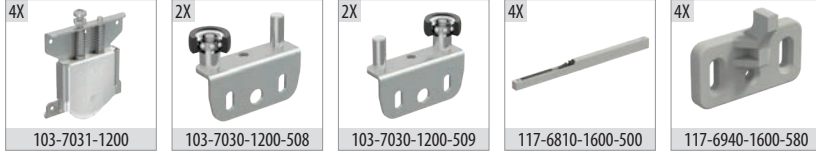

Ray Profilleri / Rail Profiles

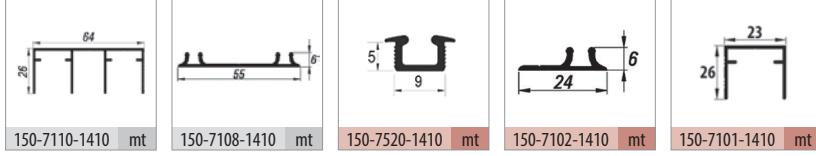

Kulp Profilleri / Handle Profiles

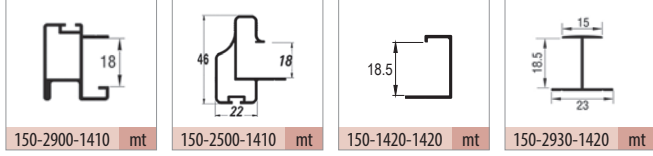

Opsiyonel Aksesuar / Optional Accessories



Teknik Detay / Technical Detail

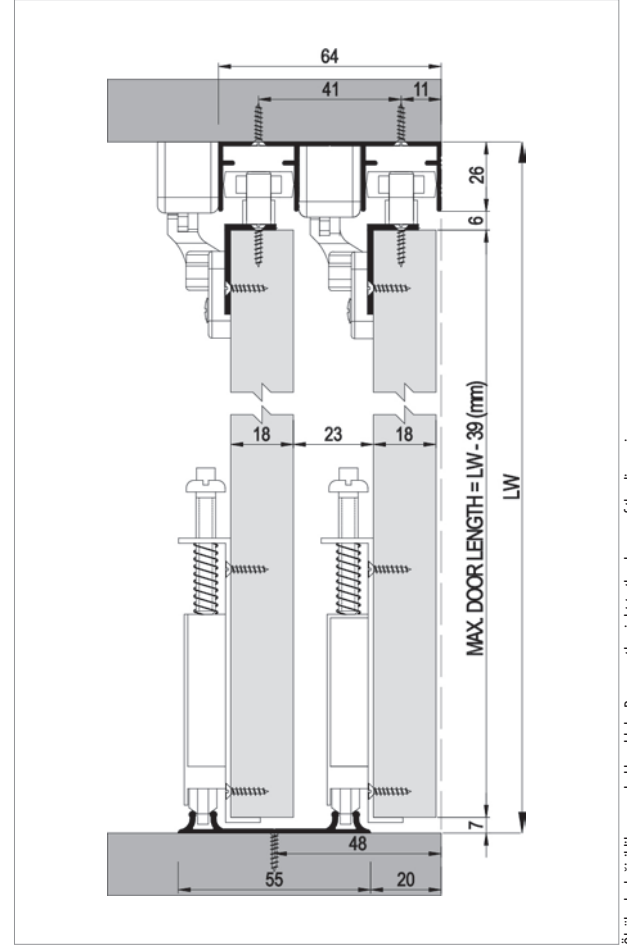

Ölçülerde değişiklik yapma hakkı saklıdır. Reserves the right to the change of the dimensions.

Kod / Code No	Açıklama / Description	Renk / Colour	Birim / Unit			Profil mt. / Profiles mt.			Bağ / Bnd.
103-0120-1200	SRG 120 - Sürme Kapak Sistemi / Sliding Door System	Silver	2 Kapak / 1 Set	12	216	-	-	-	-
117-1011-1600	Plastik Ray Tapası / Plastic Rail Cap	Gri / Grey	1 Adet / 1 Pcs	1.000	120.000	-	-	-	-
150-7110-1410	Alüminyum Üst Ray Profili / Aluminium Top Rail Profile	Eloksal / Mat Anodized	mt.	-	-	2,0	2,5	3,0	6 ad/pcs
150-7108-1410	Alüminyum Alt Ray Profili / Aluminium Bottom Rail Profile	Eloksal / Mat Anodized	mt.	-	-	2,0	2,5	3,0	12 ad/pcs
150-7520-1410	Alüminyum Alt Ray Profili / Aluminium Bottom Rail Profile	Eloksal / Mat Anodized	mt.	-	-	-	-	3,0	30 ad/pcs
150-7102-1410	Alüminyum Alt Ray Profili / Aluminium Bottom Rail Profile	Eloksal / Mat Anodized	mt.	-	-	-	-	3,0	20 ad/pcs
150-7101-1410	Alüminyum Üst Ray Profili / Aluminium Top Rail Profile	Eloksal / Mat Anodized	mt.	-	-	-	-	3,0	12 ad/pcs
150-2900-1410	Alüminyum Kulp Profili / Aluminium Handle Profile	Eloksal / Mat Anodized	mt.	-	-	2,0	-	3,0	6 ad/pcs
150-2500-1410	Alüminyum Kulp Profili / Aluminium Handle Profile	Eloksal / Mat Anodized	mt.	-	-	2,0	-	3,0	6 ad/pcs
150-1420-1420	Alüminyum Kapama Profili / Aluminium Closure Profile	Parlak / Bright	mt.	-	-	-	-	3,0	10 ad/pcs
150-2930-1420	Alüminyum Orta Kayıt / Aluminium Horizontal Central	Parlak / Bright	mt.	-	-	-	-	3,0	10 ad/pcs

Multiline SRG 125

103-0125

70 KG AYARLI SÜRME KAPAK SİSTEMİ
70 KG ADJUSTABLE SLIDING DOOR SYSTEM

Özel Üretim
Special Production

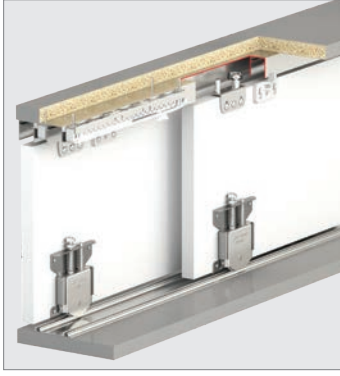

Bilgi / Information

- 1 Kutu İçeriği : 2 Kapak Mekanizma + 4 Ad Yavaşlatıcı
- In 1 box : 2 Doors Mechanism + 4 Pcs Soft Closers



103-0125 1 Set İçeriği / 1 Set Includes

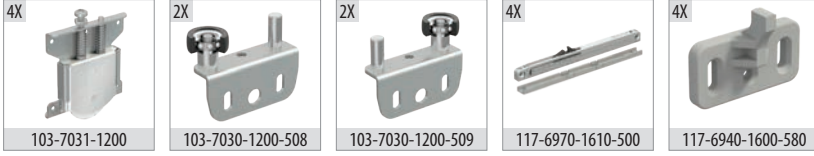

Ray Profilleri / Rail Profiles

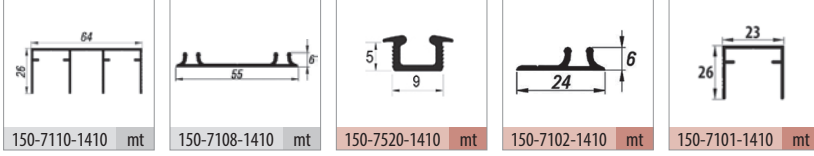

Kulp Profilleri / Handle Profiles

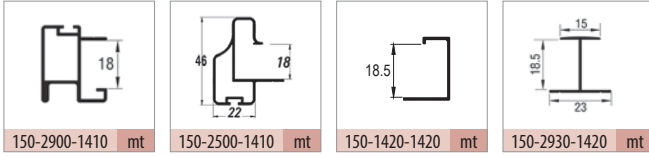

Opsiyonel Aksesuar / Optional Accessories



Teknik Detay / Technical Detail

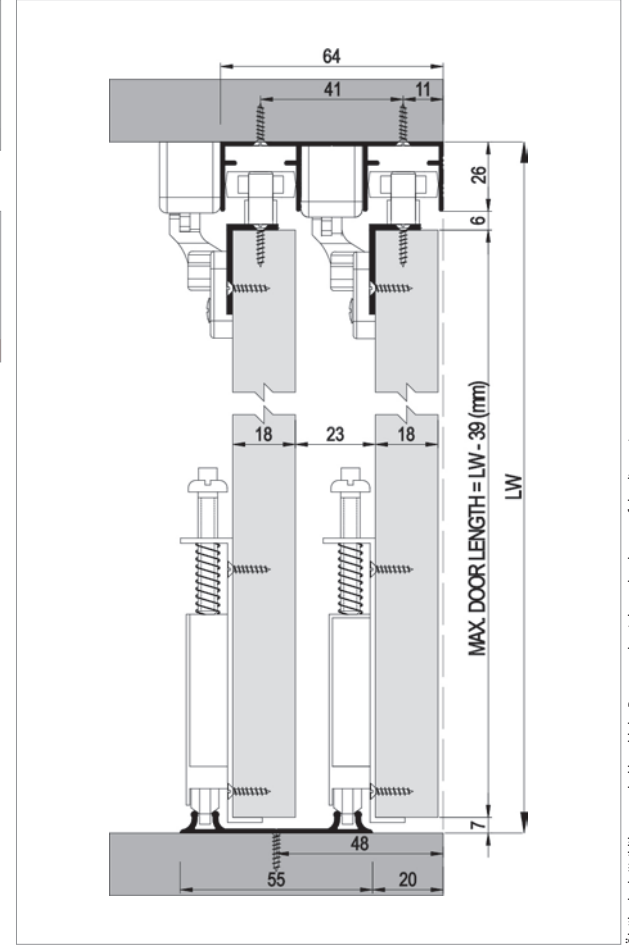

Ölçülerde değişiklik yapma hakkı saklıdır. Reserves the right to the change of the dimensions.

Kod / Code No	Açıklama / Description	Renk / Colour	Birim / Unit			Profil mt. / Profiles mt.			Bağ / Bnd.
103-0125-1200	SRG 125 - Sürme Kapak Sistemi / Sliding Door System	Silver	2 Kapak / 1 Set	12	360	-	-	-	-
117-1011-1600	Plastik Ray Tapası / Plastic Rail Cap	Gri / Grey	1 Adet / 1 Pcs	1.000	120.000	-	-	-	-
150-7110-1410	Alüminyum Üst Ray Profili / Aluminium Top Rail Profile	Eloksal / Mat Anodized	mt.	-	-	2,0	2,5	3,0	6 ad/pcs
150-7108-1410	Alüminyum Alt Ray Profili / Aluminium Bottom Rail Profile	Eloksal / Mat Anodized	mt.	-	-	2,0	2,5	3,0	12 ad/pcs
150-7520-1410	Alüminyum Alt Ray Profili / Aluminium Bottom Rail Profile	Eloksal / Mat Anodized	mt.	-	-	-	-	3,0	30 ad/pcs
150-7102-1410	Alüminyum Alt Ray Profili / Aluminium Bottom Rail Profile	Eloksal / Mat Anodized	mt.	-	-	-	-	3,0	20 ad/pcs
150-7101-1410	Alüminyum Üst Ray Profili / Aluminium Top Rail Profile	Eloksal / Mat Anodized	mt.	-	-	-	-	3,0	12 ad/pcs
150-2900-1410	Alüminyum Kulp Profili / Aluminium Handle Profile	Eloksal / Mat Anodized	mt.	-	-	2,0	-	3,0	6 ad/pcs
150-2500-1410	Alüminyum Kulp Profili / Aluminium Handle Profile	Eloksal / Mat Anodized	mt.	-	-	2,0	-	3,0	6 ad/pcs
150-1420-1420	Alüminyum Kapama Profili / Aluminium Closure Profile	Parlak / Bright	mt.	-	-	-	-	3,0	10 ad/pcs
150-2930-1420	Alüminyum Orta Kayıt / Aluminium Horizontal Central	Parlak / Bright	mt.	-	-	-	-	3,0	10 ad/pcs

Multiline SRG 130

103-0130

60 KG AYARLI SÜRME KAPAK SİSTEMİ
60 KG ADJUSTABLE SLIDING DOOR SYSTEM

Özel Üretim
Special Production

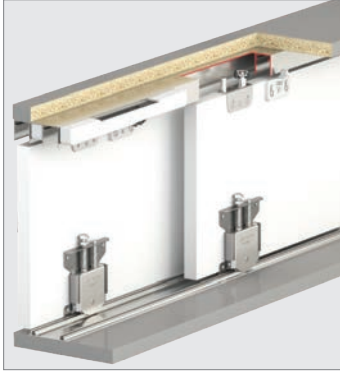

Bilgi / Information

- 1 Kutu İçeriği : 2 Kapak Mekanizma + 4 Ad Yavaşlatıcı
- In 1 box : 2 Doors Mechanism + 4 Pcs Soft Closers



103-0130 1 Set İçeriği / 1 Set Includes

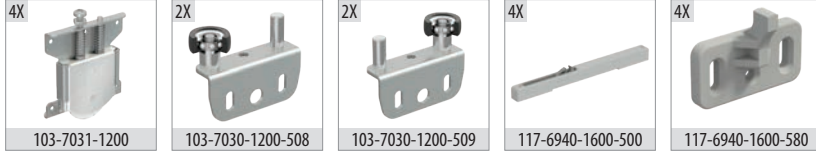

Ray Profilleri / Rail Profiles

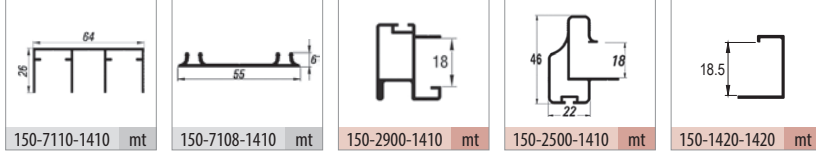

Kulp Profilleri / Handle Profiles

Teknik Detay / Technical Detail

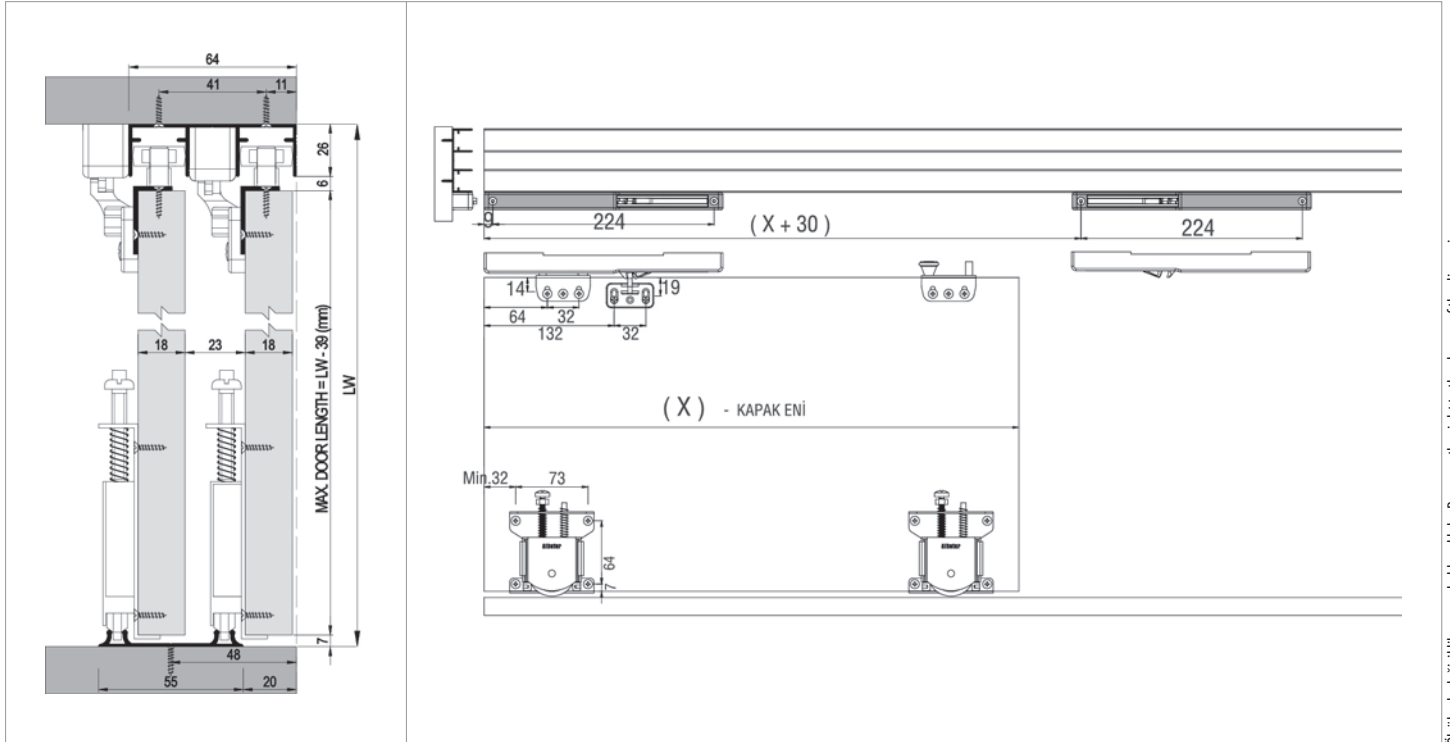

Ölçülerde değişiklik yapma hakkı saklıdır. Reserves the right to the change of the dimensions.

Kod / Code No	Açıklama / Description	Renk / Colour	Birim / Unit			Profil mt. / Profiles mt.			Bağ / Bnd.
103-0130-1200	SRG 130 - Sürme Kapak Sistemi / Sliding Door System	Silver	2 Kapak / 1 Set	12	360	-	-	-	-
150-7110-1410	Alüminyum Üst Ray Profili / Aluminium Top Rail Profile	Eloksal / Mat Anodized	mt.	-	-	2,0	2,5	3,0	6 ad/pcs
150-7108-1410	Alüminyum Alt Ray Profili / Aluminium Bottom Rail Profile	Eloksal / Mat Anodized	mt.	-	-	2,0	2,5	3,0	12 ad/pcs
150-2900-1410	Alüminyum Kulp Profili / Aluminium Handle Profile	Eloksal / Mat Anodized	mt.	-	-	2,0	-	3,0	6 ad/pcs
150-2500-1410	Alüminyum Kulp Profili / Aluminium Handle Profile	Eloksal / Mat Anodized	mt.	-	-	2,0	-	3,0	6 ad/pcs
150-1420-1420	Alüminyum Kapama Profili / Aluminium Closure Profile	Parlak / Bright	mt.	-	-	-	-	3,0	10 ad/pcs

Multiline SRG 135

103-0135

60 KG AYARLI SÜRME KAPAK SİSTEMİ
60 KG ADJUSTABLE SLIDING DOOR SYSTEM

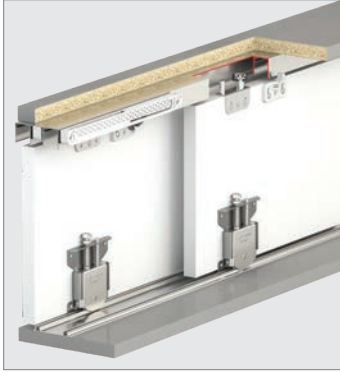

Bilgi / Information

- 1 Kutu İçeriği : 2 Kapak Mekanizma + 4 Ad Yavaşlatıcı
- In 1 box : 2 Doors Mechanism + 4 Pcs Soft Closers



103-0135 1 Set İçeriği / 1 Set Includes

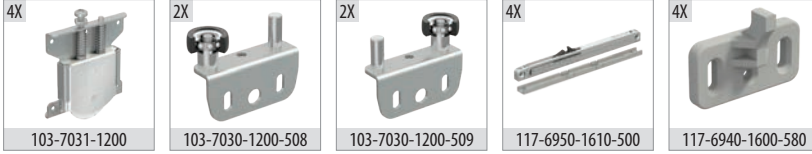

Ray Profilleri / Rail Profiles

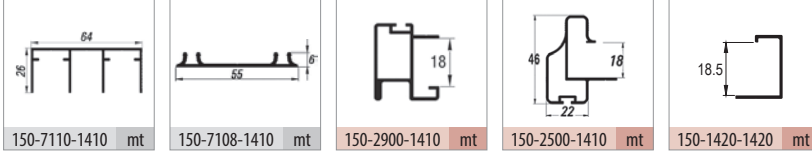

Kulp Profilleri / Handle Profiles

Teknik Detay / Technical Detail

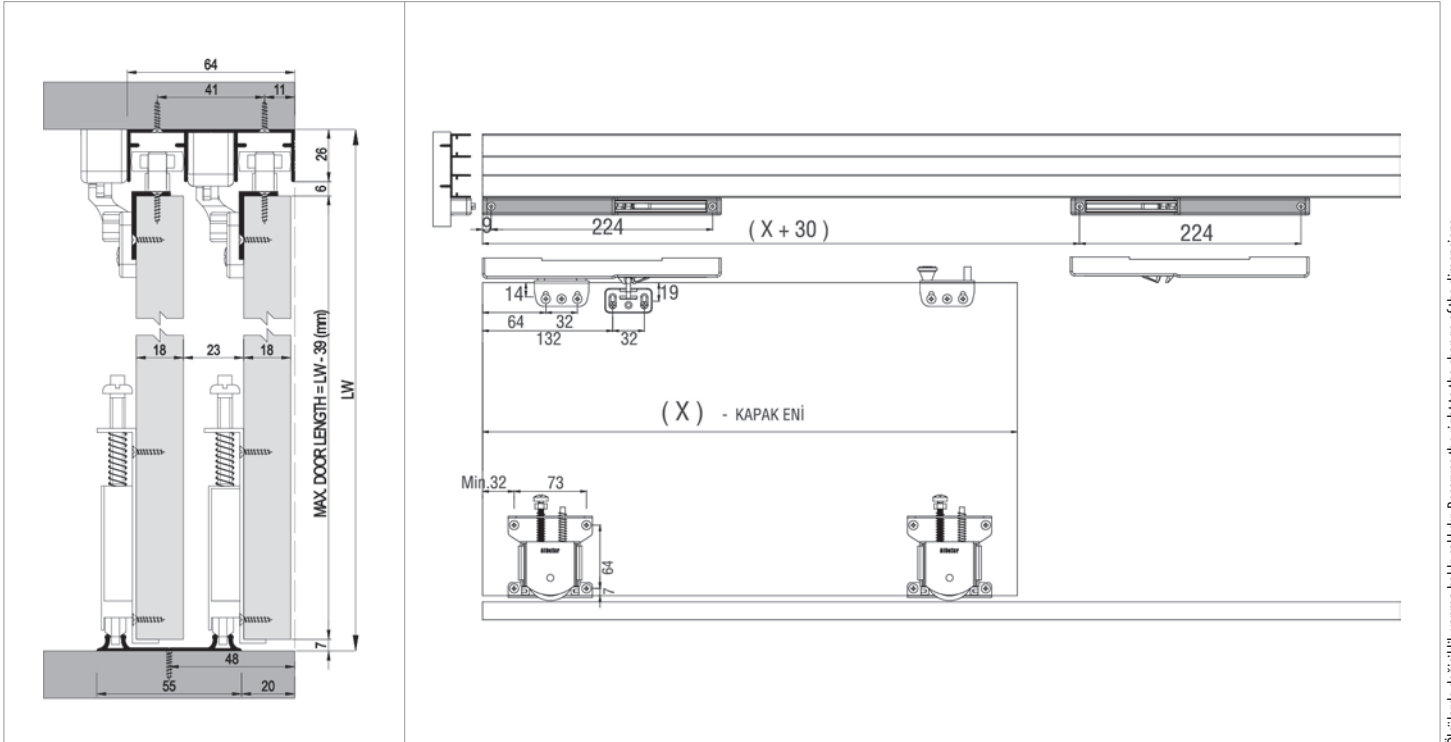

Ölçülerde değişiklik yapma hakkı saklıdır. Reserves the right to the change of the dimensions.

Kod / Code No	Açıklama / Description	Renk / Colour	Birim / Unit			Profil mt. / Profiles mt.			Bağ / Bnd.
103-0135-1200	SRG 135 - Sürme Kapak Sistemi / Sliding Door System	Silver	2 Kapak / 1 Set	12	360	-	-	-	-
150-7110-1410	Alüminyum Üst Ray Profili / Aluminium Top Rail Profile	Eloksal / Mat Anodized	mt.	-	-	2,0	2,5	3,0	6 ad/pcs
150-7108-1410	Alüminyum Alt Ray Profili / Aluminium Bottom Rail Profile	Eloksal / Mat Anodized	mt.	-	-	2,0	2,5	3,0	12 ad/pcs
150-2900-1410	Alüminyum Kulp Profili / Aluminium Handle Profile	Eloksal / Mat Anodized	mt.	-	-	2,0	-	3,0	6 ad/pcs
150-2500-1410	Alüminyum Kulp Profili / Aluminium Handle Profile	Eloksal / Mat Anodized	mt.	-	-	2,0	-	3,0	6 ad/pcs
150-1420-1420	Alüminyum Kapama Profili / Aluminium Closure Profile	Parlak / Bright	mt.	-	-	-	-	3,0	10 ad/pcs

Multiline SRG 140

103-0140

60 KG AYARLI SÜRME KAPAK SİSTEMİ
60 KG ADJUSTABLE SLIDING DOOR SYSTEM

Özel Üretim
Special Production



Bilgi / Information

- 1 Kutu İçeriği : 2 Kapak Mekanizma + 4 Ad Yavaşlatıcı
- In 1 box : 2 Doors Mechanism + 4 Pcs Soft Closers



103-0140 1 Set İçeriği / 1 Set Includes

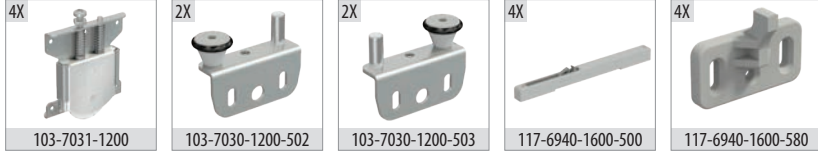

Ray Profilleri / Rail Profiles

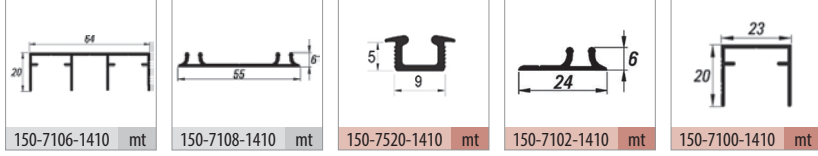

Kulp Profilleri / Handle Profiles

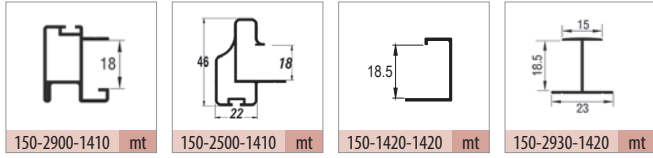

Opsiyonel Aksesuar / Optional Accessories



Teknik Detay / Technical Detail

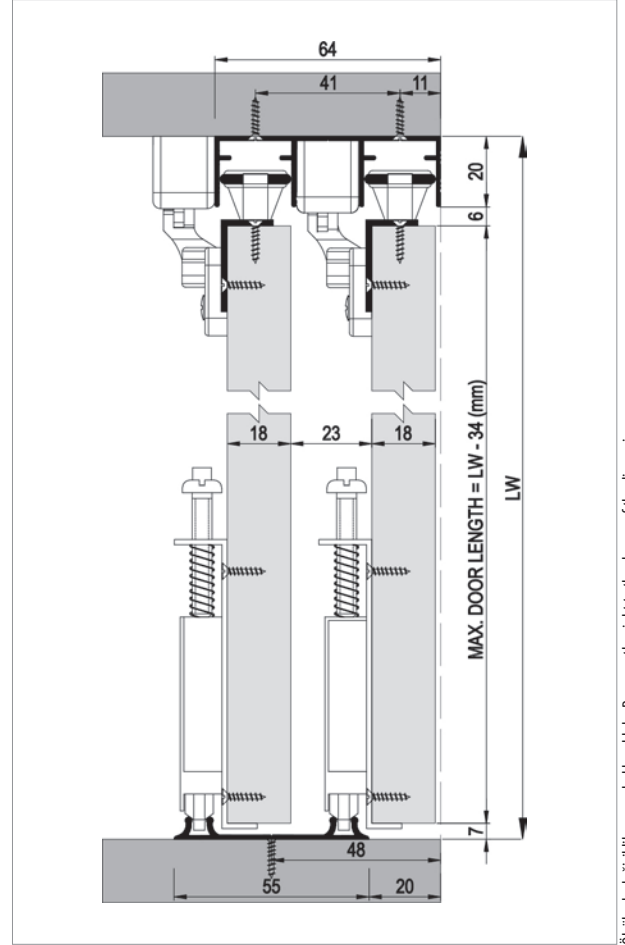

Ölçülerde değişiklik yapma hakkı saklıdır. Reserves the right to the change of the dimensions.

Kod / Code No	Açıklama / Description	Renk / Colour	Birim / Unit			Profil mt. / Profiles mt.			Bağ / Bnd.
103-0140-1200	SRG 140 - Sürme Kapak Sistemi / Sliding Door System	Silver	2 Kapak / 1 Set	12	360	-	-	-	-
117-1011-1600	Plastik Ray Tapası / Plastic Rail Cap	Gri / Grey	1 Adet / 1 Pcs	1.000	120.000	-	-	-	-
150-7106-1410	Alüminyum Üst Ray Profili / Aluminium Top Rail Profile	Eloksal / Mat Anodized	mt.	-	-	2,0	2,5	3,0	6 ad/pcs
150-7108-1410	Alüminyum Alt Ray Profili / Aluminium Bottom Rail Profile	Eloksal / Mat Anodized	mt.	-	-	2,0	2,5	3,0	12 ad/pcs
150-7520-1410	Alüminyum Alt Ray Profili / Aluminium Bottom Rail Profile	Eloksal / Mat Anodized	mt.	-	-	-	-	3,0	30 ad/pcs
150-7102-1410	Alüminyum Alt Ray Profili / Aluminium Bottom Rail Profile	Eloksal / Mat Anodized	mt.	-	-	-	-	3,0	20 ad/pcs
150-7100-1410	Alüminyum Üst Ray Profili / Aluminium Top Rail Profile	Eloksal / Mat Anodized	mt.	-	-	-	-	3,0	12 ad/pcs
150-2900-1410	Alüminyum Kulp Profili / Aluminium Handle Profile	Eloksal / Mat Anodized	mt.	-	-	2,0	-	3,0	6 ad/pcs
150-2500-1410	Alüminyum Kulp Profili / Aluminium Handle Profile	Eloksal / Mat Anodized	mt.	-	-	2,0	-	3,0	6 ad/pcs
150-1420-1420	Alüminyum Kapama Profili / Aluminium Closure Profile	Parlak / Bright	mt.	-	-	-	-	3,0	10 ad/pcs
150-2930-1420	Alüminyum Orta Kayıt / Aluminium Horizontal Central	Parlak / Bright	mt.	-	-	-	-	3,0	10 ad/pcs

Multiline SRG 145

103-0145

60 KG AYARLI SÜRME KAPAK SİSTEMİ
60 KG ADJUSTABLE SLIDING DOOR SYSTEM

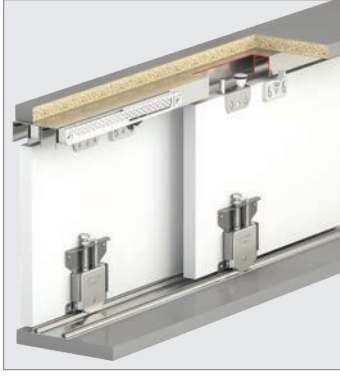

Bilgi / Information

- 1 Kutu İçeriği : 2 Kapak Mekanizma + 4 Ad Yavaşlatıcı
- In 1 box : 2 Doors Mechanism + 4 Pcs Soft Closers



103-0145 1 Set İçeriği / 1 Set Includes

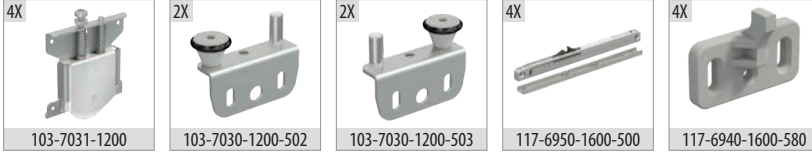

Ray Profilleri / Rail Profiles

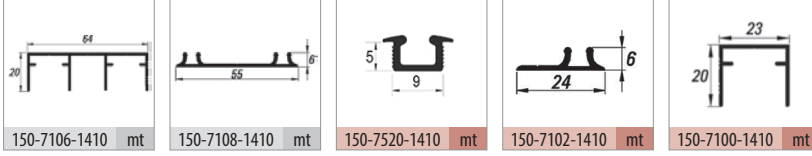

Kulp Profilleri / Handle Profiles

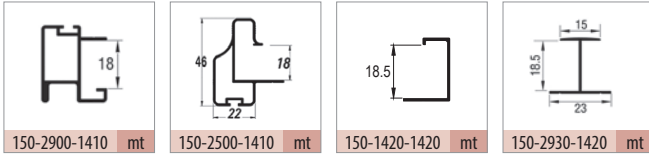

Opsiyonel Aksesuar / Optional Accessories



Teknik Detay / Technical Detail

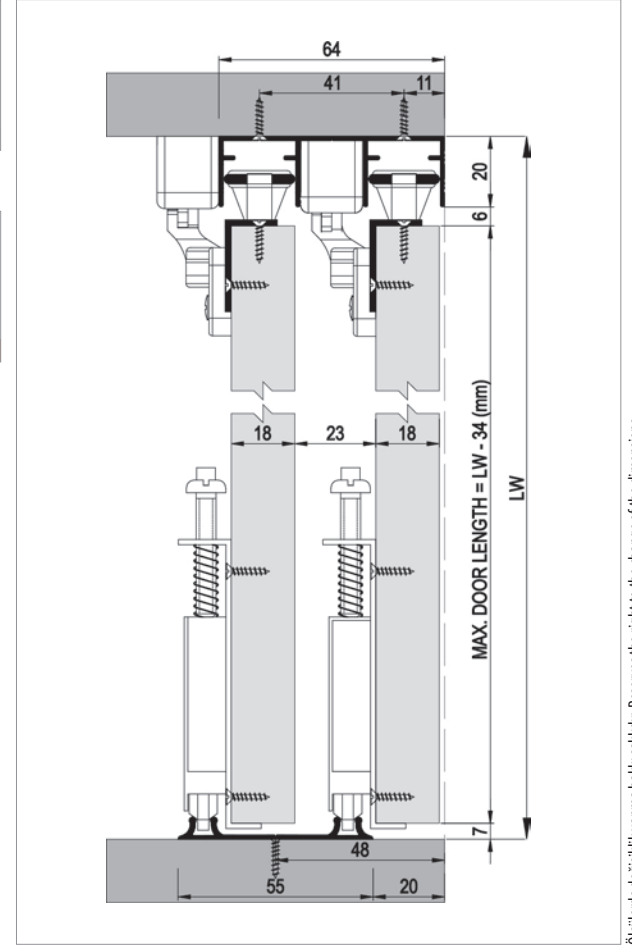

Ölçülerde değişiklik yapıma hakkı saklıdır. Reserves the right to the change of the dimensions.

Kod / Code No	Açıklama / Description	Renk / Colour	Birim / Unit			Profil mt. / Profiles mt.			Bağ / Bnd.
103-0145-1200	SRG 145 - Sürme Kapak Sistemi / Sliding Door System	Silver	2 Kapak / 1 Set	12	360	-	-	-	-
117-1011-1600	Plastik Ray Tapası / Plastic Rail Cap	Gri / Grey	1 Adet / 1 Pcs	1.000	120.000	-	-	-	-
150-7106-1410	Alüminyum Üst Ray Profili / Aluminium Top Rail Profile	Eloksal / Mat Anodized	mt.	-	-	2,0	2,5	3,0	6 ad/pcs
150-7108-1410	Alüminyum Alt Ray Profili / Aluminium Bottom Rail Profile	Eloksal / Mat Anodized	mt.	-	-	2,0	2,5	3,0	12 ad/pcs
150-7520-1410	Alüminyum Alt Ray Profili / Aluminium Bottom Rail Profile	Eloksal / Mat Anodized	mt.	-	-	-	-	3,0	30 ad/pcs
150-7102-1410	Alüminyum Alt Ray Profili / Aluminium Bottom Rail Profile	Eloksal / Mat Anodized	mt.	-	-	-	-	3,0	20 ad/pcs
150-7100-1410	Alüminyum Üst Ray Profili / Aluminium Top Rail Profile	Eloksal / Mat Anodized	mt.	-	-	-	-	3,0	12 ad/pcs
150-2900-1410	Alüminyum Kulp Profili / Aluminium Handle Profile	Eloksal / Mat Anodized	mt.	-	-	2,0	-	3,0	6 ad/pcs
150-2500-1410	Alüminyum Kulp Profili / Aluminium Handle Profile	Eloksal / Mat Anodized	mt.	-	-	2,0	-	3,0	6 ad/pcs
150-1420-1420	Alüminyum Kapama Profili / Aluminium Closure Profile	Parlak / Bright	mt.	-	-	-	-	3,0	10 ad/pcs
150-2930-1420	Alüminyum Orta Kayıt / Aluminium Horizontal Central	Parlak / Bright	mt.	-	-	-	-	3,0	10 ad/pcs

Multiline 7036

103-7036

70 KG AYARLI SÜRME KAPAK SİSTEMİ
70 KG ADJUSTABLE SLIDING DOOR SYSTEM

Özel Üretim
Special Production

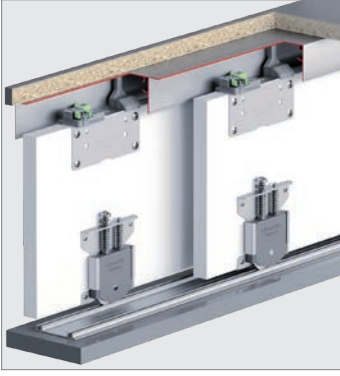

Bilgi / Information

- 1 Kutu İçeriği : 2 Kapak Mekanizma
- In 1 box : 2 Doors Mechanism

- 3 Kapaklı Dolap Uygulaması
- 3 Doors Wardrobe Application

Yavaşlatıcı Alternatifi / Soft Closer Alternative

117-6740-1610 <>>

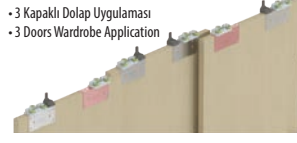

103-7036 1 Takım İçeriği / 1 Kit Includes

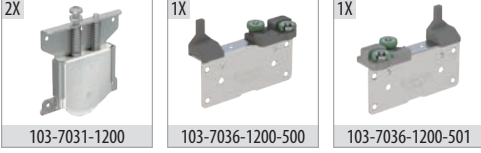

Ray Profilleri / Rail Profiles

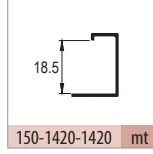
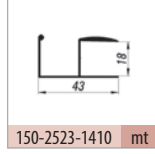
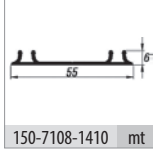
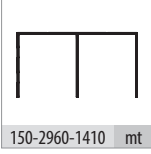

Kulp / Handle Profiles

Opsiyonel / Optional

Teknik Detay / Technical Detail

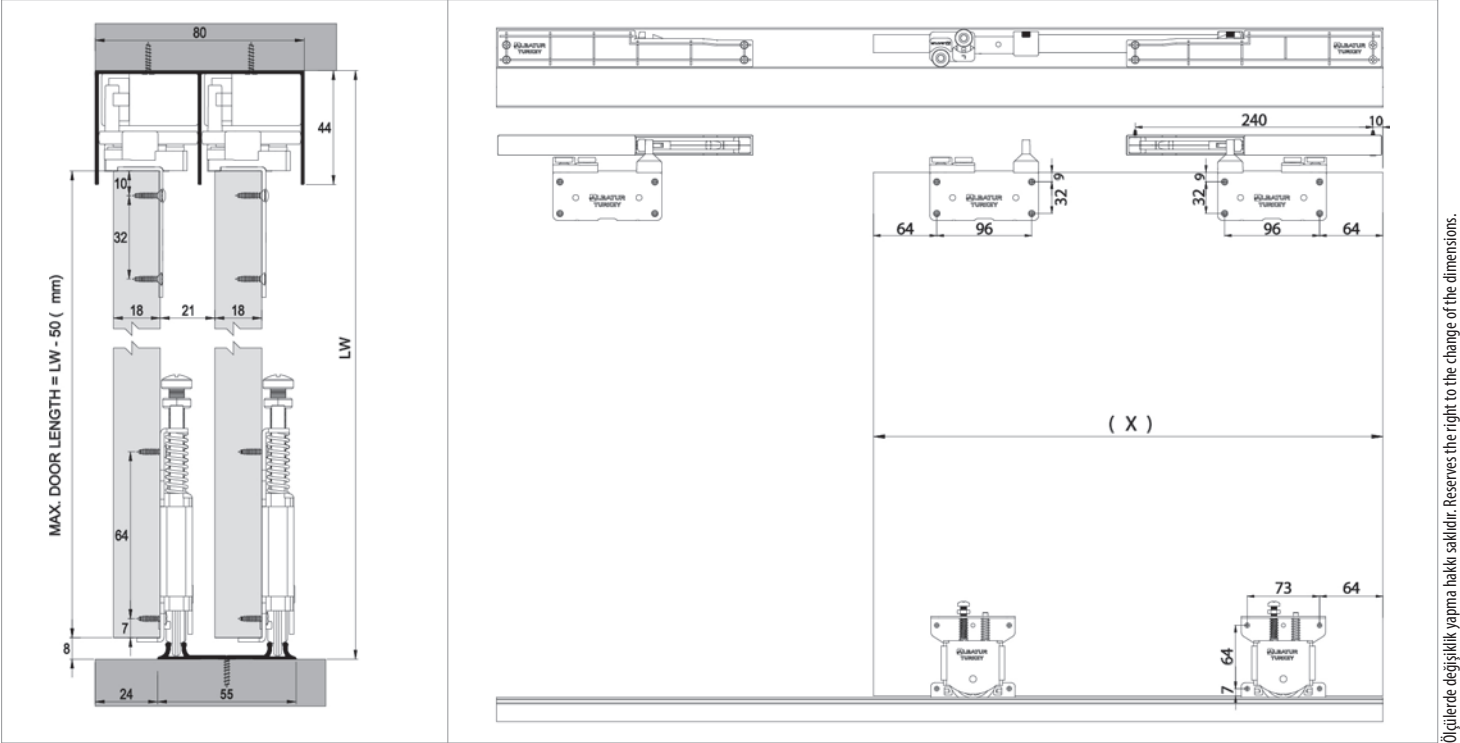

Ölçülerde değişiklik yapma hakkı saklıdır. Reserves the right to the change of the dimensions.

Kod / Code No	Açıklama / Description	Renk / Colour	Birim / Unit			Profil mt. / Profiles mt.			Bağ / Bnd.
103-7036-1200	7036 - 70 Kg Sürme Kapak Sistemi / Sliding Door System	Silver	1 Kapak / 1 Kit	24	720	-	-	-	-
117-1011-1600	Plastik Ray Tapası / Plastic Rail Cap	Gri / Grey	1 Adet / 1 Pcs	1.000	120.000	-	-	-	-
150-2960-1410	Alüminyum Üst Ray Profili / Aluminium Top Rail Profile	Eloksal / Mat Anodized	mt.	-	-	2,0	2,5	3,0	6 ad/pcs
150-7108-1410	Alüminyum Alt Ray Profili / Aluminium Bottom Rail Profile	Eloksal / Mat Anodized	mt.	-	-	2,0	2,5	3,0	12 ad/pcs
150-2523-1410	Alüminyum Kulp Profili / Aluminium Handle Profile	Eloksal / Mat Anodized	mt.	-	-	-	2,5	-	10 ad/pcs
150-1420-1420	Alüminyum Kapama Profili / Aluminium Closure Profile	Parlak / Bright	mt.	-	-	-	-	3,0	10 ad/pcs

Multiline 7038

103-7038

70 KG AYARLI SÜRME KAPAK SİSTEMİ
70 KG ADJUSTABLE SLIDING DOOR SYSTEM

Özel Üretim
Special Production

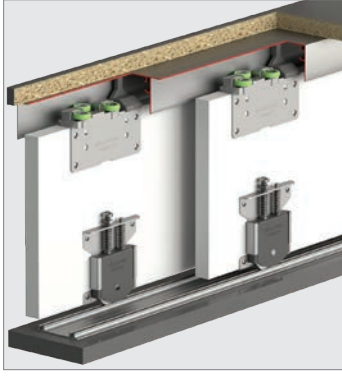

Bilgi / Information

- 1 Kutu İçeriği : 2 Kapak Mekanizma
- In 1 box : 2 Doors Mechanism

- 3 Kapaklı Dolap Uygulaması
- 3 Doors Wardrobe Application

Yavaşlatıcı Alternatifi / Soft Closer Alternative

117-6740-1610 <<>>



103-7038 1 Takım İçeriği / 1 Kit Includes

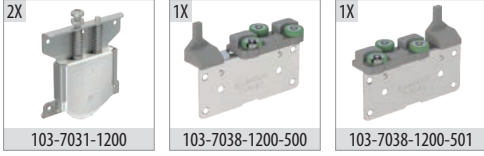

Ray Profilleri / Rail Profiles

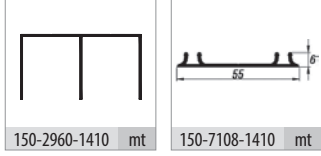

Kulp / Handle Profiles

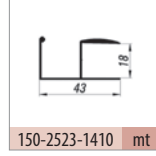

Opsiyonel / Optional



Teknik Detay / Technical Detail

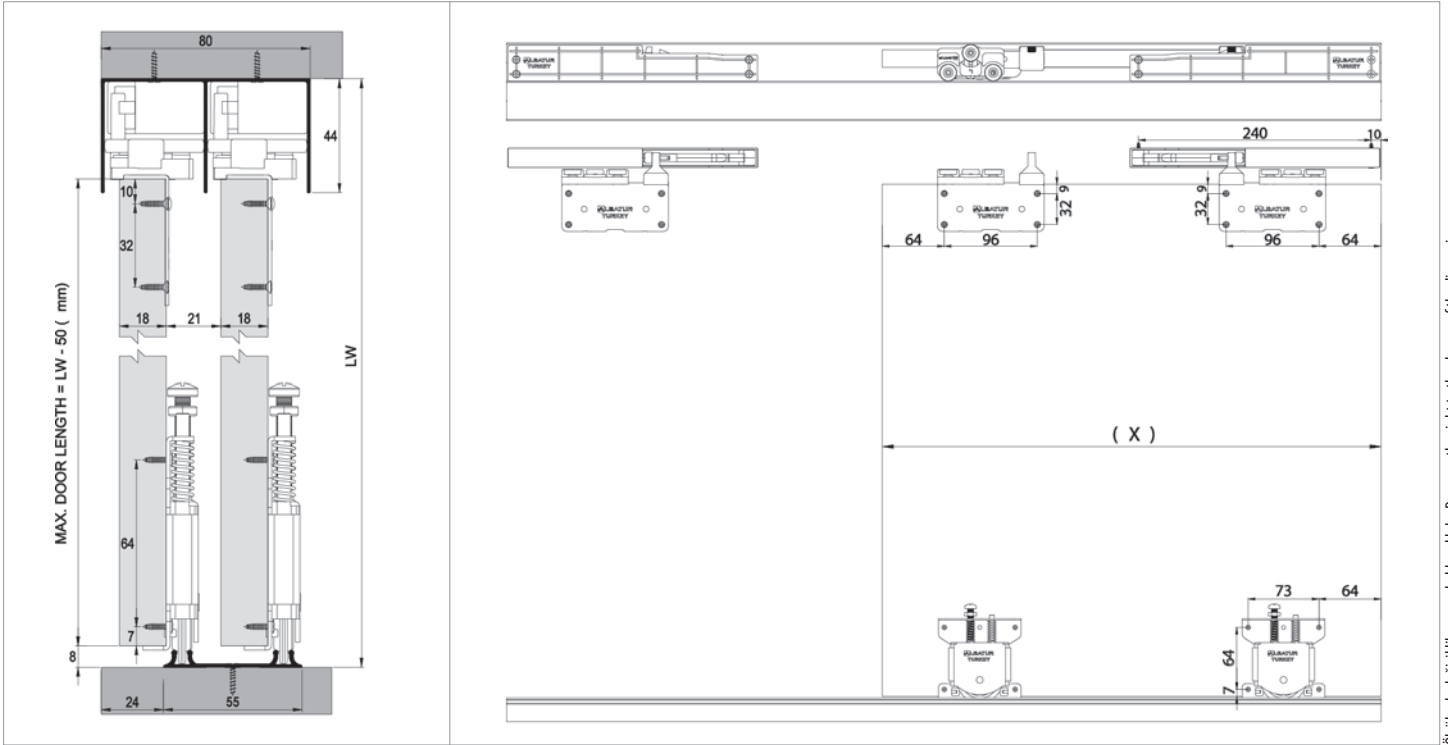

Ölçülerde değişiklik yapma hakkı saklıdır. Reserves the right to the change of the dimensions.

Kod / Code No	Açıklama / Description	Renk / Colour	Birim / Unit			Profil mt. / Profiles mt.			Bağ / Bnd.
103-7038-1200	7038 - 70 Kg Sürme Kapak Sistemi / Sliding Door System	Silver	1 Kapak / 1 Kit	24	720	-	-	-	-
117-1011-1600	Plastik Ray Tapası / Plastic Rail Cap	Gri / Grey	1 Adet / 1 Pcs	1.000	120.000	-	-	-	-
150-2960-1410	Alüminyum Üst Ray Profili / Aluminium Top Rail Profile	Eloksal / Mat Anodized	mt.	-	-	2,0	2,5	3,0	6 ad/pcs
150-7108-1410	Alüminyum Alt Ray Profili / Aluminium Bottom Rail Profile	Eloksal / Mat Anodized	mt.	-	-	2,0	2,5	3,0	12 ad/pcs
150-2523-1410	Alüminyum Kulp Profili / Aluminium Handle Profile	Eloksal / Mat Anodized	mt.	-	-	-	2,5	-	10 ad/pcs
150-1420-1420	Alüminyum Kapama Profili / Aluminium Closure Profile	Parlak / Bright	mt.	-	-	-	-	3,0	10 ad/pcs

Multiline 7030

103-7030

75 KG AYARLI SÜRME KAPAK SİSTEMİ
75 KG ADJUSTABLE SLIDING DOOR SYSTEM



Bilgi / Information

- 1 Kutu İçeriği : 2 Kapak Mekanizma
- In 1 box : 2 Doors Mechanism

Yavaşlatıcı Alternatifi / Soft Closer Alternative

- 117-6942-1610 <<>>
- 117-6950-1610 <<>>
- 117-6970-1610 <<>>
- 117-6940-1600 <<>>
- 117-6666-1610 >>
- 117-6710-1610 >>



103-7030 1 Takım İçeriği / 1 Kit Includes

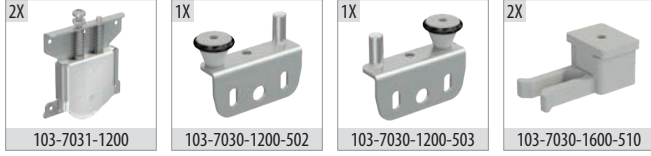

Ray Profilleri / Rail Profiles

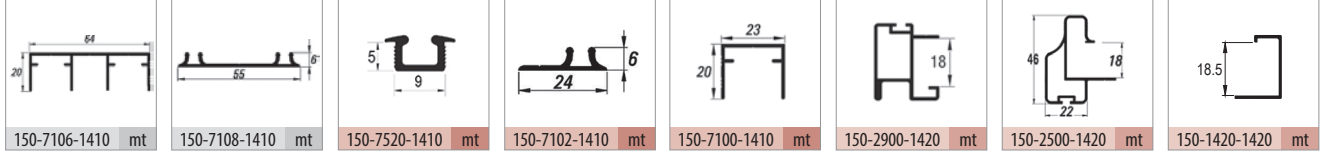

Kulp Profilleri / Handle Profiles

Teknik Detay / Technical Detail

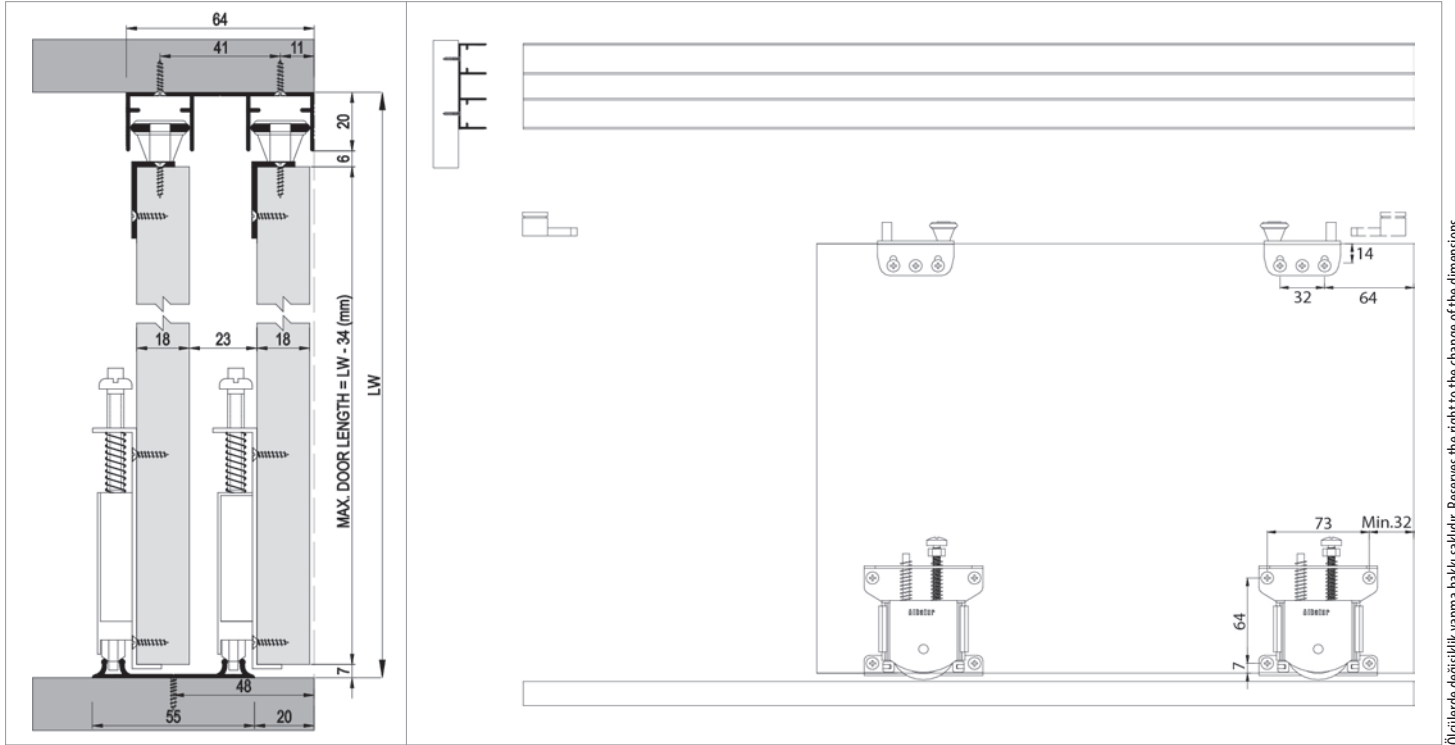

Ölçülerde değişiklik yapma hakkı saklıdır. Reserves the right to the change of the dimensions.

Kod / Code No	Açıklama / Description	Renk / Colour	Birim / Unit			Profil mt. / Profiles mt.			Bağ / Bnd.
103-7030-1200	7030 - Sürme Kapak Sistemi / Sliding Door System	Silver	1 Kapak / 1 Kit	32	1.024	-	-	-	-
150-7106-1410	Alüminyum Üst Ray Profili / Aluminium Top Rail Profile	Eloksal / Mat Anodized	mt.	-	-	2,0	2,5	3,0	6 ad/pcs
150-7108-1410	Alüminyum Alt Ray Profili / Aluminium Bottom Rail Profile	Eloksal / Mat Anodized	mt.	-	-	2,0	2,5	3,0	12 ad/pcs
150-2900-1420	Alüminyum Kulp Profili / Aluminium Handle Profile	Parlak / Bright	mt.	-	-	2,0	2,5	3,0	6 ad/pcs
150-2500-1420	Alüminyum Kulp Profili / Aluminium Handle Profile	Parlak / Bright	mt.	-	-	2,0	-	3,0	6 ad/pcs
150-1420-1420	Alüminyum Kapama Profili / Aluminium Closure Profile	Parlak / Bright	mt.	-	-	-	-	3,0	10 ad/pcs

Multiline 7031

103-7031

75 KG AYARLI SÜRME KAPAK SİSTEMİ
75 KG ADJUSTABLE SLIDING DOOR SYSTEM



■ Yavaşlatıcı Alternatifi / Soft Closer Alternative

117-6666-1610 ►► 117-6710-1610 ►►



■ 103-7031

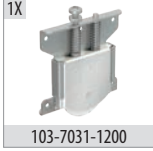

■ Ray Profilleri / Rail Profiles

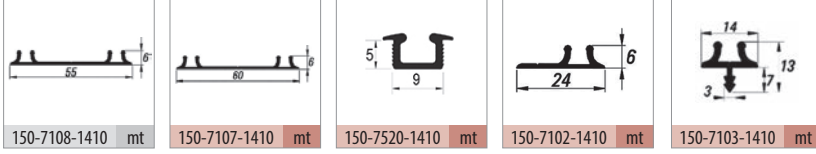

■ Kulp Profilleri / Handle Profiles

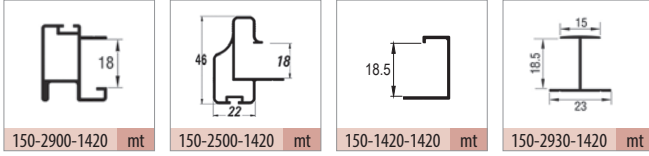

■ Opsiyonel Aksesuar / Optional Accessories

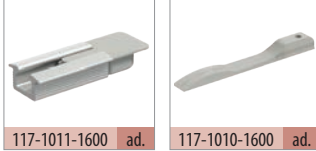

■ Teknik Detay / Technical Detail

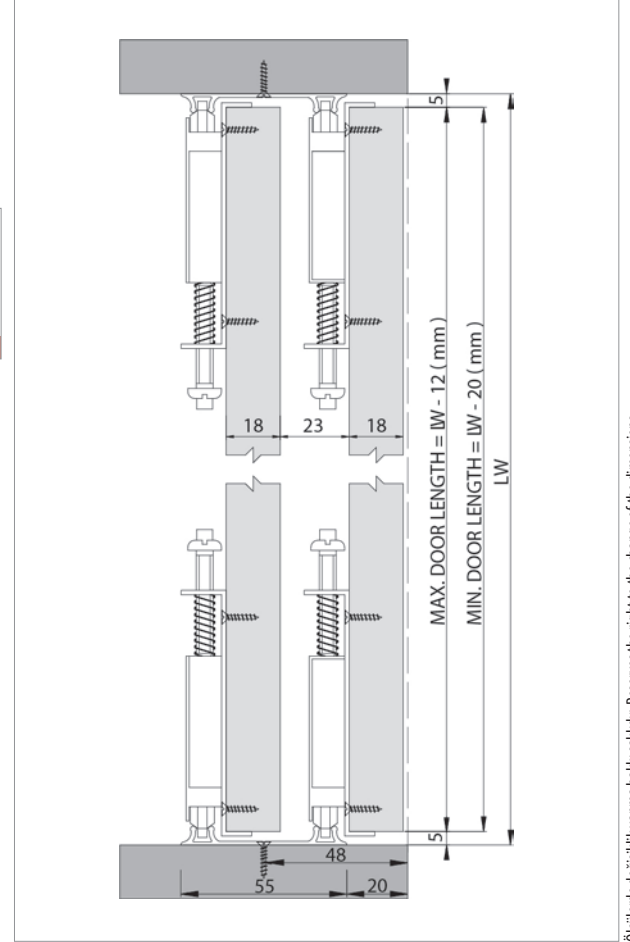

Ölçülerde değişiklik yapma hakkı saklıdır. Reserves the right to the change of the dimensions.

Kod / Code No	Açıklama / Description	Renk / Colour	Birim / Unit			Profil mt. / Profiles mt.			Bağ / Bnd.
103-7031-1200	Sürme Kapak Sistemi / Sliding Door System	Silver	1 Adet / 1 Pcs	96	3.072	-	-	-	-
117-1010-1600	Plastik Stoper / Plastic Stopper	Gri / Grey	1 Adet / 1 Pcs	1.056	126.000	-	-	-	-
117-1011-1600	Plastik Ray Tapası / Plastic Rail Cap	Gri / Grey	1 Adet / 1 Pcs	1.000	120.000	-	-	-	-
150-7108-1410	Alüminyum Alt-Üst Ray / Aluminium Bottom-Top Rail	Eloksal / Mat Anodized	mt.	-	-	2,0	2,5	3,0	12 ad/pcs
150-7107-1410	Alüminyum Alt-Üst Ray / Aluminium Bottom-Top Rail	Eloksal / Mat Anodized	mt.	-	-	2,0	2,5	3,0	12 ad/pcs
150-7520-1410	Alüminyum Alt-Üst Ray / Aluminium Bottom-Top Rail	Eloksal / Mat Anodized	mt.	-	-	-	-	3,0	30 ad/pcs
150-7102-1410	Alüminyum Alt-Üst Ray / Aluminium Bottom-Top Rail	Eloksal / Mat Anodized	mt.	-	-	-	-	3,0	20 ad/pcs
150-7103-1410	Alüminyum Alt-Üst Ray / Aluminium Bottom-Top Rail	Eloksal / Mat Anodized	mt.	-	-	-	-	3,0	30 ad/pcs
150-2900-1420	Alüminyum Kulp Profili / Aluminium Handle Profile	Parlak / Bright	mt.	-	-	2,0	2,5	3,0	6 ad/pcs
150-2500-1420	Alüminyum Kulp Profili / Aluminium Handle Profile	Parlak / Bright	mt.	-	-	2,0	-	3,0	6 ad/pcs
150-1420-1420	Alüminyum Kapama Profili / Aluminium Closure Profile	Parlak / Bright	mt.	-	-	-	-	3,0	10 ad/pcs
150-2930-1420	Alüminyum Orta Kayıt / Aluminium Horizontal Central	Parlak / Bright	mt.	-	-	-	-	3,0	10 ad/pcs

Multiline 7032

103-7032

75 KG AYARLI SÜRME KAPAK SİSTEMİ
75 KG ADJUSTABLE SLIDING DOOR SYSTEM



Bilgi / Information

- 1 Kutu İçeriği : 2 Kapak Mekanizma
- In 1 box : 2 Doors Mechanism

Yavaşlatıcı Alternatifi / Soft Closer Alternative

- 117-6950-1610 <<>>
- 117-6970-1610 <<>>
- 117-6810-1600 <<>>
- 117-6940-1600 <<>>
- 117-6666-1610 >>
- 117-6710-1610 >>



103-7032 1 Takım İçeriği / 1 Kit Includes

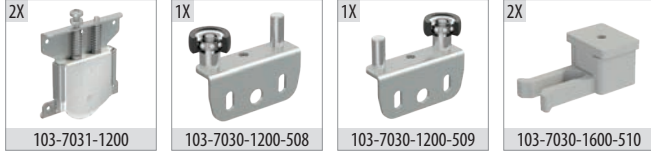

Ray Profilleri / Rail Profiles

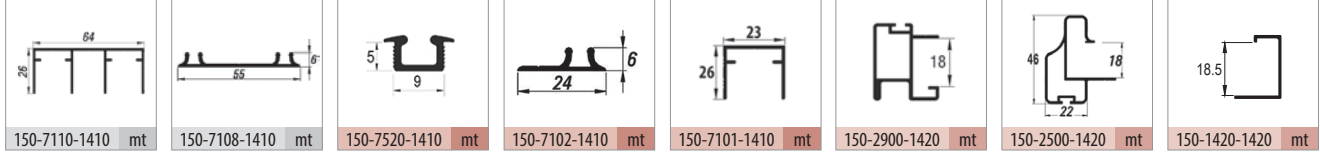

Kulp Profilleri / Handle Profiles

Teknik Detay / Technical Detail

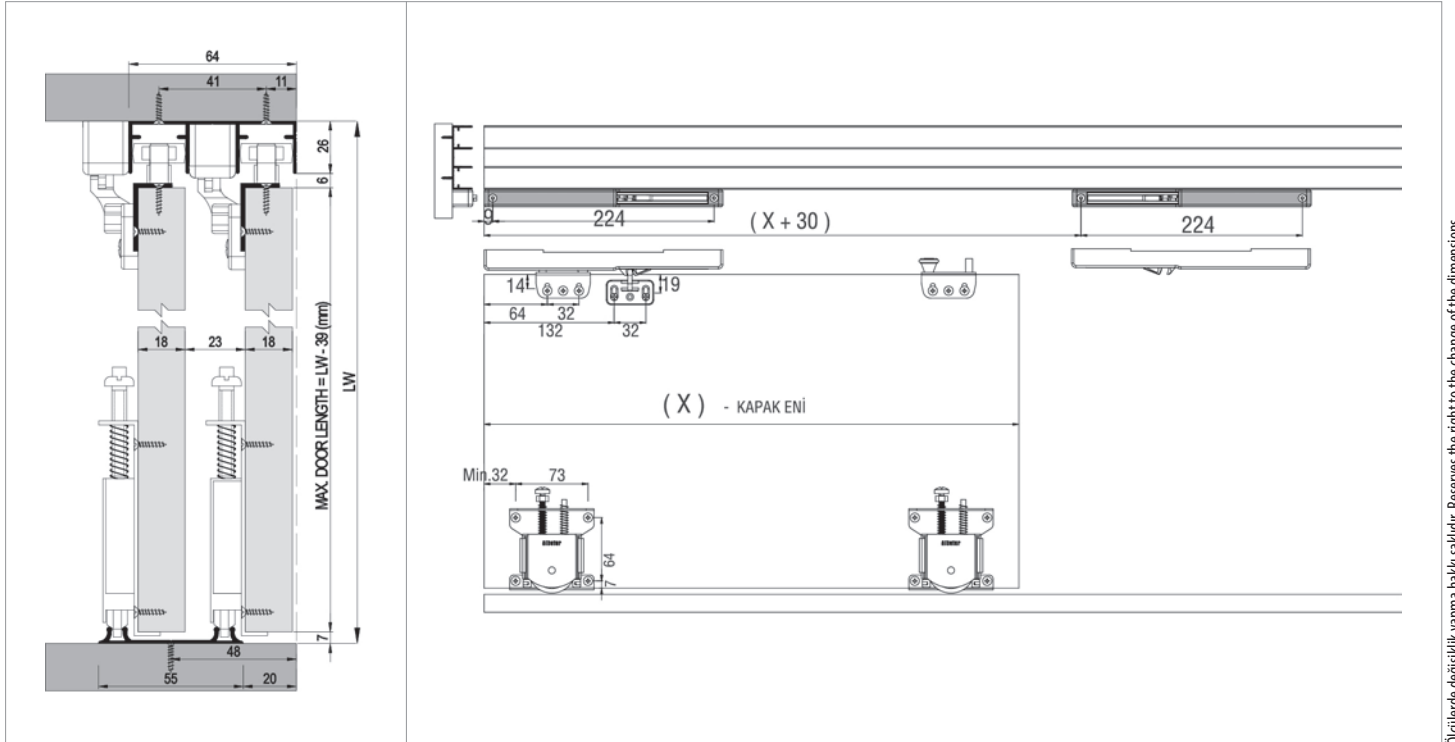

Kod / Code No	Açıklama / Description	Renk / Colour	Birim / Unit			Profil mt. / Profiles mt.			Bağ / Bnd.
103-7032-1200	7030 SFT -75 Kg Sürme Kapak Sistemi / 75 Kg Sliding Door System	Silver	1 Kapak / 1 Kit	32	1.024	-	-	-	-
150-7110-1410	Alüminyum Üst Ray Profili / Aluminium Top Rail Profile	Eloksal / Mat Anodized	mt.	-	-	2,0	2,5	3,0	6 ad/pcs
150-7108-1410	Alüminyum Alt Ray Profili / Aluminium Bottom Rail Profile	Eloksal / Mat Anodized	mt.	-	-	2,0	2,5	3,0	12 ad/pcs
150-2900-1420	Alüminyum Kulp Profili / Aluminium Handle Profile	Parlak / Bright	mt.	-	-	2,0	2,5	3,0	6 ad/pcs
150-2500-1420	Alüminyum Kulp Profili / Aluminium Handle Profile	Parlak / Bright	mt.	-	-	2,0	-	3,0	6 ad/pcs
150-1420-1420	Alüminyum Kapama Profili / Aluminium Closure Profile	Parlak / Bright	mt.	-	-	-	-	3,0	10 ad/pcs

Multiline 7012

103-7012

80 KG AYARLI SÜRME KAPAK SİSTEMİ
80 KG ADJUSTABLE SLIDING DOOR SYSTEM

Özel Üretim
Special Production

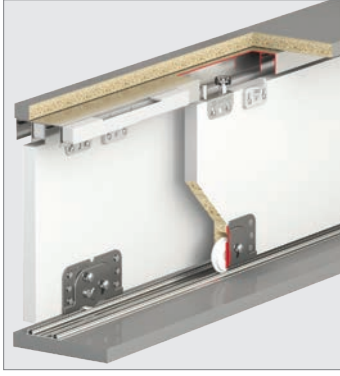

Bilgi / Information

- 1 Kutu İçeriği : 2 Kapak Mekanizma
- In 1 box : 2 Doors Mechanism

Yavaşlatıcı Alternatifi / Soft Closer Alternative

- 117-6950-1610 <<>>
- 117-6970-1610 <<>>
- 117-6666-1610 >>>>
- 117-6710-1610 >>>>
- 117-6942-1610 <<>>



103-7012 1 Takım İçeriği / 1 Kit Includes

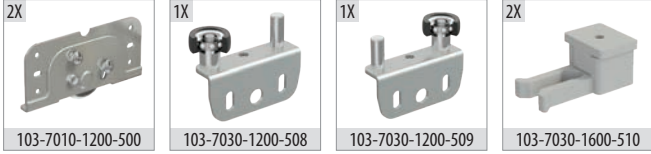

Ray Profilleri / Rail Profiles

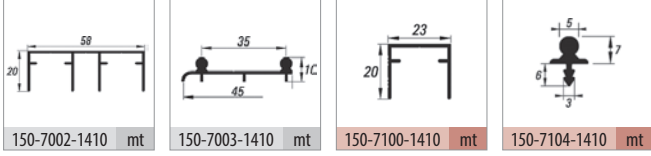

Kulp Profilleri / Handle Profiles

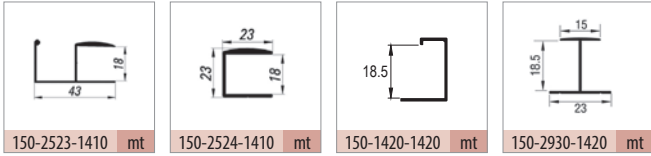

Uygulama / Application



Teknik Detay / Technical Detail

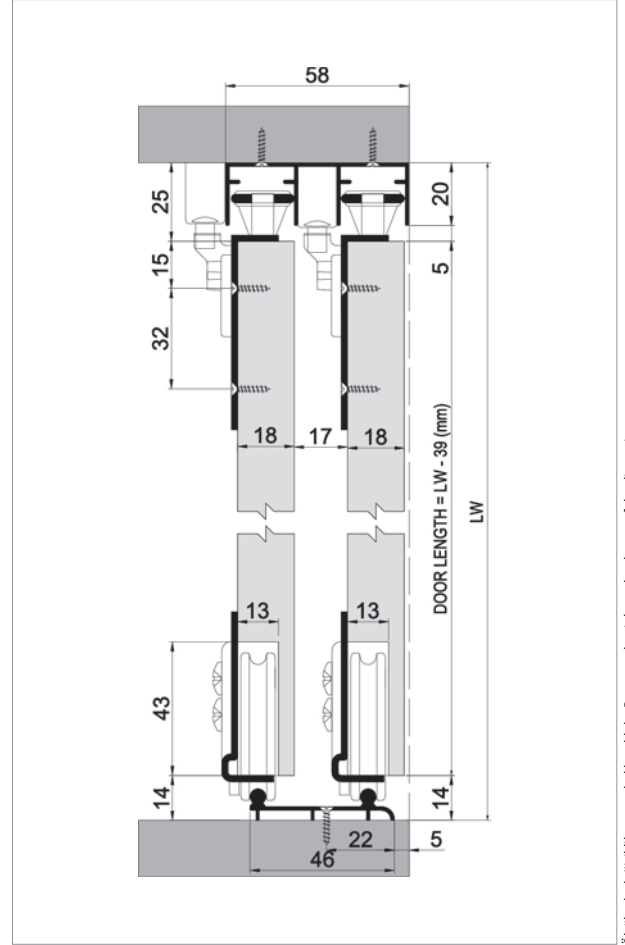

Ölçülerde değişiklik yapma hakkı saklıdır. Reserves the right to the change of the dimensions.

Kod / Code No	Açıklama / Description	Renk / Colour	Birim / Unit			Profil mt. / Profiles mt.	Bağ / Bnd.
103-7012-1200	80 Kg Sürme Kapak Sistemi / 80 Kg Sliding Door System	Silver	1 Kapak / 1 Kit	32	1.024	- - -	-
150-7002-1410	Alüminyum Üst Ray Profili / Aluminium Top Rail Profile	Eloksal / Mat Anodized	mt.	-	-	2,0 - 3,0	10 ad/pcs
150-7003-1410	Alüminyum Alt Ray Profili / Aluminium Bottom Rail Profile	Eloksal / Mat Anodized	mt.	-	-	2,0 - 3,0	10 ad/pcs
150-7100-1410	Alüminyum Üst Ray Profili / Aluminium Top Rail Profile	Eloksal / Mat Anodized	mt.	-	-	- 3,0	12 ad/pcs
150-7104-1410	Alüminyum Alt Ray Profili / Aluminium Bottom Rail Profile	Eloksal / Mat Anodized	mt.	-	-	- 3,0	50 ad/pcs
150-2523-1410	Alüminyum Kulp Profili / Aluminium Handle Profile	Eloksal / Mat Anodized	mt.	-	-	- 2,5 3,0	10 ad/pcs
150-2524-1410	Alüminyum Kapama Profili / Aluminium Closure Profile	Eloksal / Mat Anodized	mt.	-	-	- 2,5 3,0	10 ad/pcs
150-1420-1420	Alüminyum Kapama Profili / Aluminium Closure Profile	Parlak / Bright	mt.	-	-	- 3,0	10 ad/pcs
150-2930-1420	Alüminyum Orta Kayıt / Aluminium Horizontal Central	Parlak / Bright	mt.	-	-	- 3,0	10 ad/pcs

Multiline 7010

103-7010

80 KG AYARLI SÜRME KAPAK SİSTEMİ
80 KG ADJUSTABLE SLIDING DOOR SYSTEM

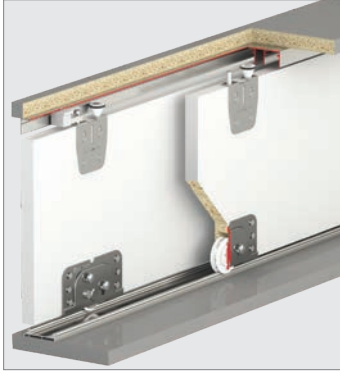

Bilgi / Information

- 1 Kutu İçeriği : 2 Kapak Mekanizma
- In 1 box : 2 Doors Mechanism



Yavaşlatıcı Alternatifi / Soft Closer Alternative

- 117-6950-1610 <<>> 117-6970-1610 <<>> 117-6942-1610 <<>>
- 117-6940-1600 <<>> 117-6666-1610 >> 117-6710-1610 >>

103-7010 1 Takım İçeriği / 1 Kit Includes

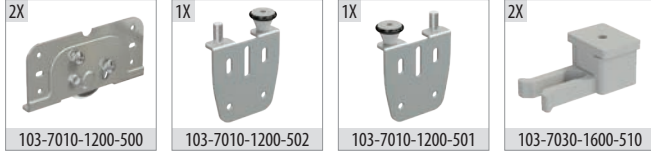

Ray Profilleri / Rail Profiles

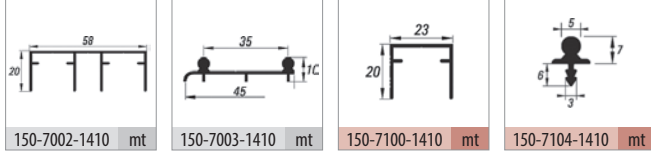

Kulp Profilleri / Handle Profiles

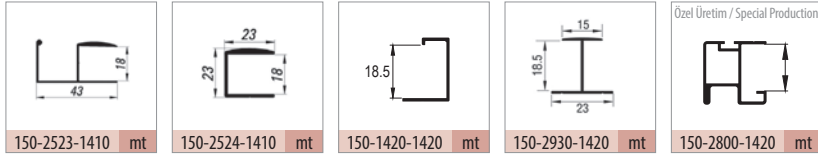

Uygulama / Application



Teknik Detay / Technical Detail

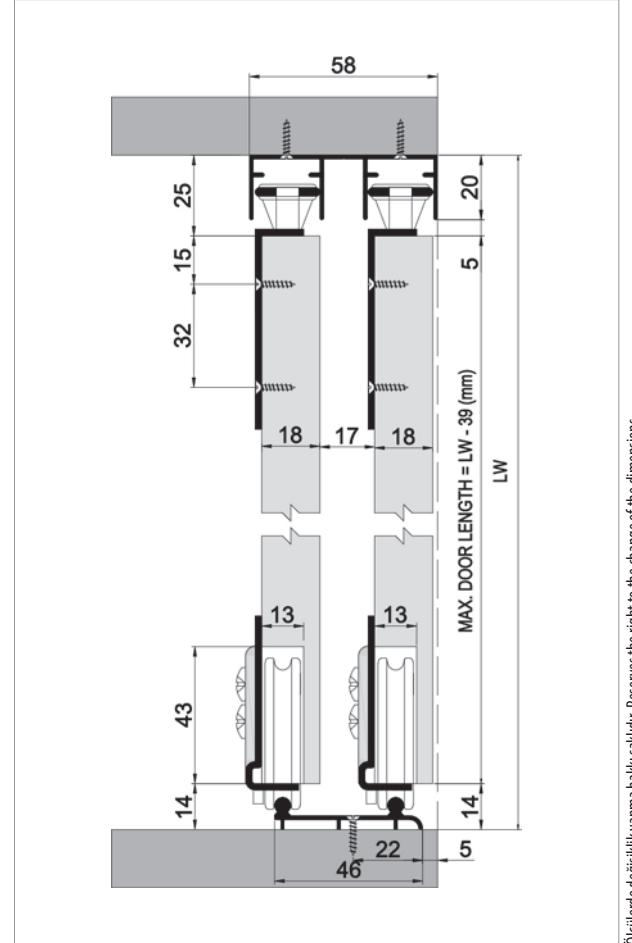

Ölçülerde değişiklik yapma hakkı saklıdır. Reserves the right to the change of the dimensions.

Kod / Code No	Açıklama / Description	Renk / Colour	Birim / Unit			Profil mt. / Profiles mt.			Bağ / Bnd.
103-7010-1200	80 Kg Sürme Kapak Sistemi / 80 Kg Sliding Door System	Silver	1 Kapak / 1 Kit	32	1.024	-	-	-	-
150-7002-1410	Alüminyum Üst Ray Profili / Aluminium Top Rail Profile	Eloksal / Mat Anodized	mt.	-	-	2,0	-	3,0	10 ad/pcs
150-7003-1410	Alüminyum Alt Ray Profili / Aluminium Bottom Rail Profile	Eloksal / Mat Anodized	mt.	-	-	2,0	-	3,0	10 ad/pcs
150-7100-1410	Alüminyum Üst Ray Profili / Aluminium Top Rail Profile	Eloksal / Mat Anodized	mt.	-	-	2,0	2,5	3,0	12 ad/pcs
150-7104-1410	Alüminyum Alt Ray Profili / Aluminium Bottom Rail Profile	Eloksal / Mat Anodized	mt.	-	-	2,0	-	3,0	50 ad/pcs
150-2523-1410	Alüminyum Kulp Profili / Aluminium Handle Profile	Eloksal / Mat Anodized	mt.	-	-	-	2,5	3,0	10 ad/pcs
150-2524-1410	Alüminyum Kapama Profili / Aluminium Closure Profile	Eloksal / Mat Anodized	mt.	-	-	-	2,5	3,0	10 ad/pcs
150-1420-1420	Alüminyum Kapama Profili / Aluminium Closure Profile	Parlak / Bright	mt.	-	-	-	-	3,0	10 ad/pcs
150-2930-1420	Alüminyum Orta Kayıt / Aluminium Horizontal Central	Parlak / Bright	mt.	-	-	-	-	3,0	10 ad/pcs
150-2800-1420	Alüminyum Kulp Profili / Aluminium Handle Profile	Parlak / Bright	mt.	-	-	-	-	3,0	6 ad/pcs

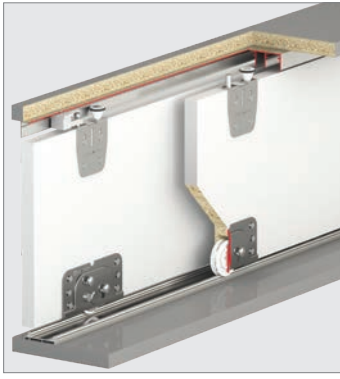

Bilgi / Information

- 1 Kutu İçeriği : 2 Kapak Mekanizma
- In 1 box : 2 Doors Mechanism

Yavaşlatıcı Alternatifi / Soft Closer Alternative

- 117-6950-1610 <<>>
- 117-6970-1610 <<>>
- 117-6810-1600 <<>>
- 117-6940-1600 <<>>
- 117-6666-1610 >>
- 117-6710-1610 >>



103-7011 1 Takım İçeriği / 1 Kit Includes

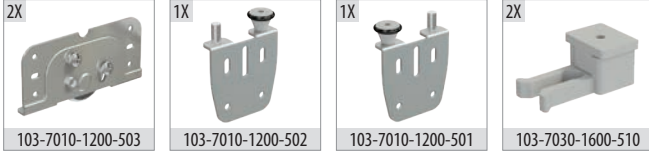

Ray Profilleri / Rail Profiles

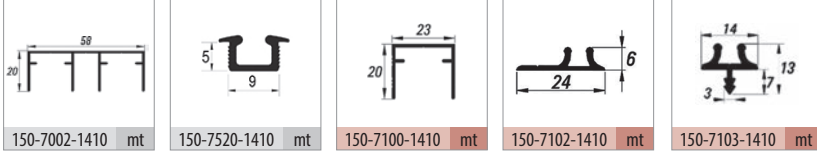

Kulp Profilleri / Handle Profiles

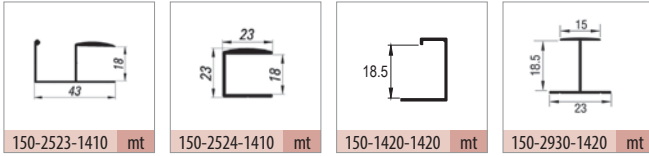

Opsiyonel Aksesuar / Optional Accessories



Teknik Detay / Technical Detail

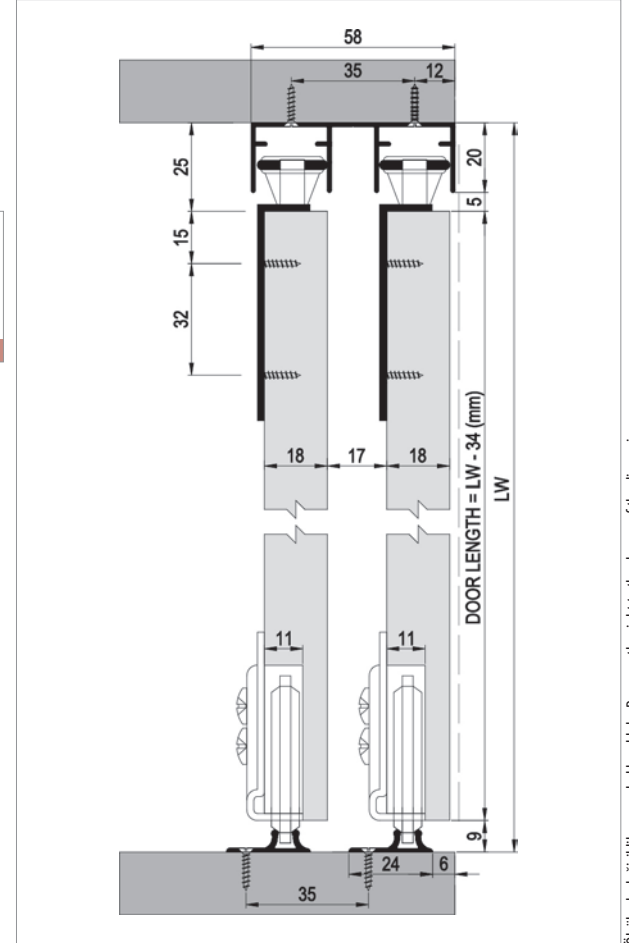

Ölçülerde değişiklik yapma hakkı saklıdır. Reserves the right to the change of the dimensions.

Kod / Code No	Açıklama / Description	Renk / Colour	Birim / Unit			Profil mt. / Profiles mt.	Bağ / Bnd.
103-7011-1200	70 Kg Sürme Kapak Sistemi / 70 Kg Sliding Door System	Silver	1 Kapak / 1 Kit	32	1.024	- - -	-
117-1011-1600	Plastik Ray Tapası / Plastic Rail Cap	Gri / Grey	1 Adet / 1 Pcs	1.000	120.000	- - -	-
150-7002-1410	Alüminyum Üst Ray Profili / Aluminium Top Rail Profile	Eloksal / Mat Anodized	mt.	-	-	2,0 - 3,0	10 ad/pcs
150-7520-1410	Alüminyum Alt Ray Profili / Aluminium Bottom Rail Profile	Eloksal / Mat Anodized	mt.	-	-	- 3,0	30 ad/pcs
150-7100-1410	Alüminyum Üst Ray Profili / Aluminium Top Rail Profile	Eloksal / Mat Anodized	mt.	-	-	- 3,0	12 ad/pcs
150-7102-1410	Alüminyum Alt Ray Profili / Aluminium Bottom Rail Profile	Eloksal / Mat Anodized	mt.	-	-	- 3,0	20 ad/pcs
150-7103-1410	Alüminyum Alt Ray Profili / Aluminium Bottom Rail Profile	Eloksal / Mat Anodized	mt.	-	-	- 3,0	30 ad/pcs
150-2523-1410	Alüminyum Kulp Profili / Aluminium Handle Profile	Eloksal / Mat Anodized	mt.	-	-	- 2,5 3,0	10 ad/pcs
150-2524-1410	Alüminyum Kapama Profili / Aluminium Closure Profile	Eloksal / Mat Anodized	mt.	-	-	- 2,5 3,0	10 ad/pcs
150-1420-1420	Alüminyum Kapama Profili / Aluminium Closure Profile	Parlak / Bright	mt.	-	-	- 3,0	10 ad/pcs
150-2930-1420	Alüminyum Orta Kayıt / Aluminium Horizontal Central	Parlak / Bright	mt.	-	-	- 3,0	10 ad/pcs

Multiline 7020

103-7020

70 KG AYARLI SÜRME KAPAK SİSTEMİ
70 KG ADJUSTABLE SLIDING DOOR SYSTEM

Özel Üretim
Special Production

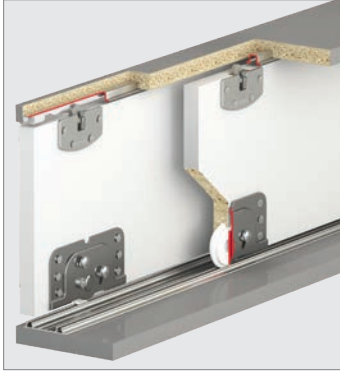

Bilgi / Information

- 1 Kutu İçeriği : 2 Kapak Mekanizma
- In 1 box : 2 Doors Mechanism

Yavaşlatıcı Alternatifi / Soft Closer Alternative

117-6666-1610 ▶▶ 117-6710-1610 ▶▶



103-7020 1 Takım İçeriği / 1 Kit Includes

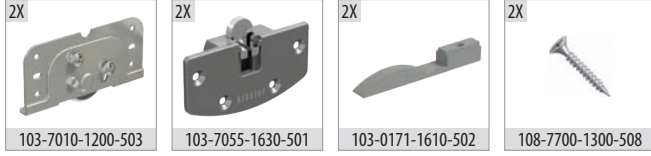

Ray Profilleri / Rail Profiles

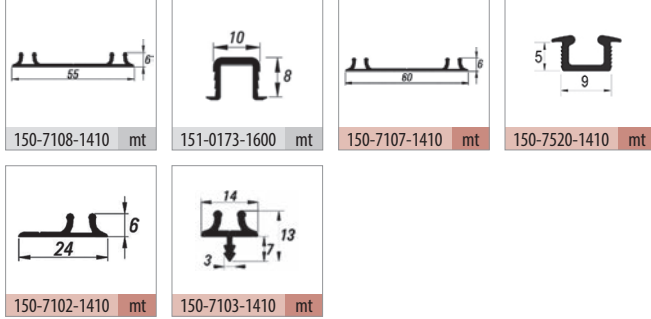

Kulp Profilleri / Handle Profiles

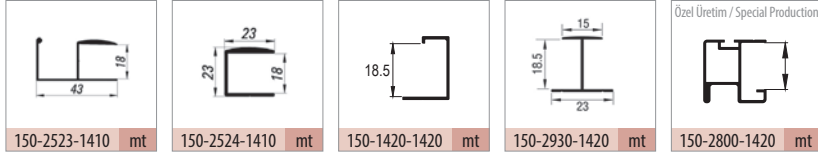

Opsiyonel Aksesuar / Optional Accessories



Teknik Detay / Technical Detail

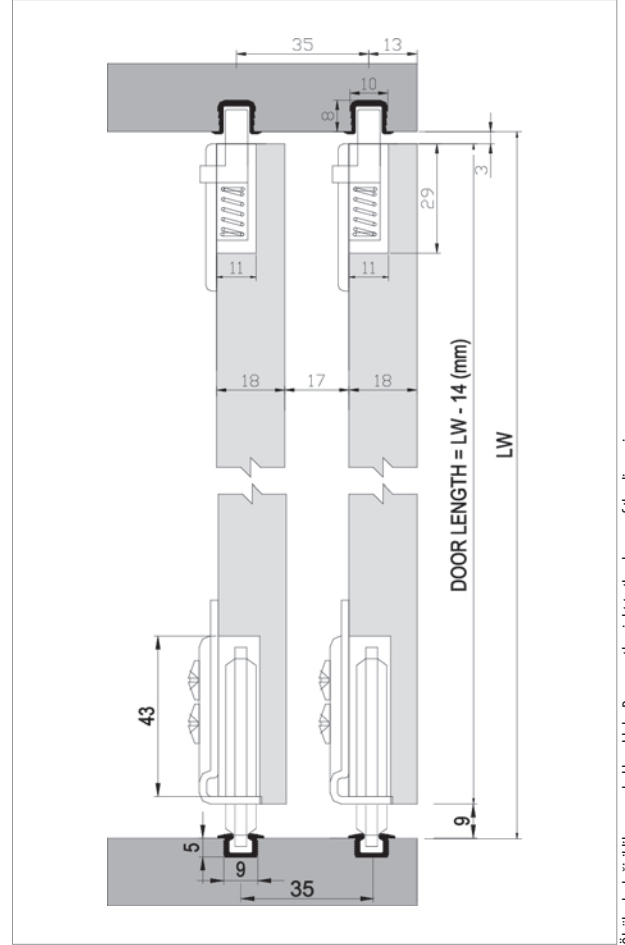

Ölçülerde değişiklik yapma hakkı saklıdır. Reserves the right to the change of the dimensions.

Kod / Code No	Açıklama / Description	Renk / Colour	Birim / Unit			Profil mt. / Profiles mt.	Bağ / Bnd.
103-7020-1200	70 Kg Sürme Kapak Sistemi / 70 Kg Sliding Door System	Silver	1 Kapak / 1 Kit	32	1.024	- - -	-
117-1011-1600	Plastik Ray Tapası / Plastic Rail Cap	Gri / Grey	1 Adet / 1 Pcs	1.000	120.000	- - -	-
151-0173-1600	PVC Üst Ray Profili / PVC Top Rail Profile	Gri / Grey	mt.	-	-	- - 3,0	50 ad/pcs
150-7108-1410	Alüminyum Alt Ray Profili / Aluminium Bottom Rail Profile	Eloksal / Mat Anodized	mt.	-	-	2,0 2,5 3,0	12 ad/pcs
150-7107-1410	Alüminyum Alt Ray Profili / Aluminium Bottom Rail Profile	Eloksal / Mat Anodized	mt.	-	-	2,0 - 3,0	12 ad/pcs
150-7520-1410	Alüminyum Alt Ray Profili / Aluminium Bottom Rail Profile	Eloksal / Mat Anodized	mt.	-	-	- - 3,0	30 ad/pcs
150-7102-1410	Alüminyum Alt Ray Profili / Aluminium Bottom Rail Profile	Eloksal / Mat Anodized	mt.	-	-	- - 3,0	20 ad/pcs
150-7103-1410	Alüminyum Alt Ray Profili / Aluminium Bottom Rail Profile	Eloksal / Mat Anodized	mt.	-	-	- - 3,0	30 ad/pcs
150-2523-1410	Alüminyum Kulp Profili / Aluminium Handle Profile	Eloksal / Mat Anodized	mt.	-	-	- 2,5 3,0	10 ad/pcs
150-2524-1410	Alüminyum Kapama Profili / Aluminium Closure Profile	Eloksal / Mat Anodized	mt.	-	-	- 2,5 3,0	10 ad/pcs
150-1420-1420	Alüminyum Kapama Profili / Aluminium Closure Profile	Parlak / Bright	mt.	-	-	- - 3,0	10 ad/pcs
150-2930-1420	Alüminyum Orta Kayıt / Aluminium Horizontal Central	Parlak / Bright	mt.	-	-	- - 3,0	10 ad/pcs

Multiline 7060

103-7060

60 KG AYARLI SÜRME KAPAK SİSTEMİ
60 KG ADJUSTABLE SLIDING DOOR SYSTEM

Özel Üretim
Special Production

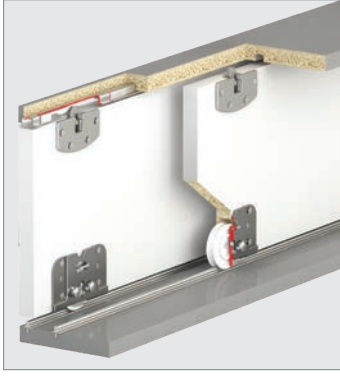

Bilgi / Information

- 1 Kutu İçeriği : 2 Kapak Mekanizma
- In 1 box : 2 Doors Mechanism

Yavaşlatıcı Alternatifi / Soft Closer Alternative

117-6942-1610 ► 117-6666-1610 ► 117-6710-1610 ►



103-7060 1 Takım İçeriği / 1 Kit Includes

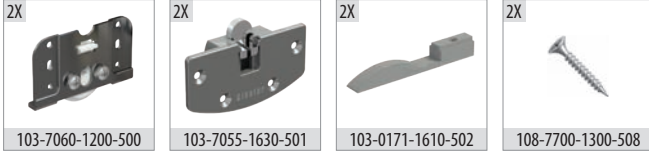

Ray Profilleri / Rail Profiles

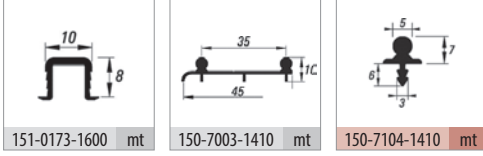

Kulp Profilleri / Handle Profiles

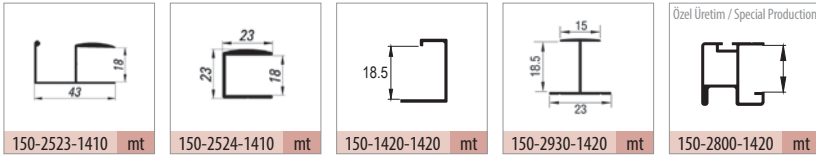

Teknik Detay / Technical Detail

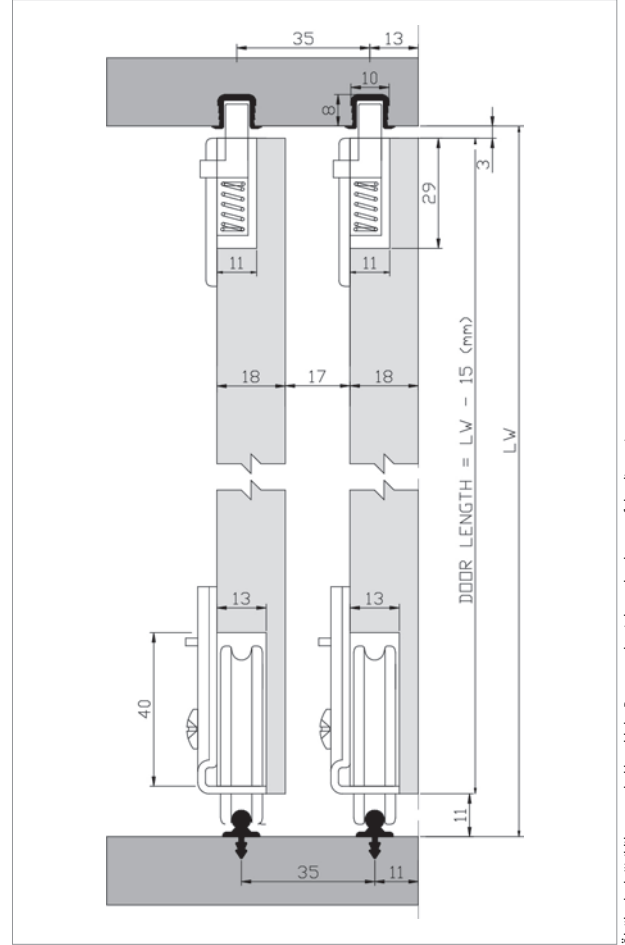

Ölçülerde değişiklik yapma hakkı saklıdır. Reserves the right to the change of the dimensions.

Kod / Code No	Açıklama / Description	Renk / Colour	Birim / Unit			Profil mt. / Profiles mt.	Bağ / Bnd.
103-7060-1200	60 Kg Sürme Kapak Sistemi / 60 Kg Sliding Door System	Silver	1 Kapak / 1 Kit	48	1.152	-	-
151-0173-1600	PVC Üst Ray Profili / PVC Top Rail Profile	Gri / Grey	mt.	-	-	-	3,0
150-7003-1410	Alüminyum Alt Ray Profili / Aluminium Bottom Rail Profile	Eloksal / Mat Anodized	mt.	-	-	2,0	3,0
150-7104-1410	Alüminyum Alt Ray Profili / Aluminium Bottom Rail Profile	Eloksal / Mat Anodized	mt.	-	-	-	3,0
150-2523-1410	Alüminyum Kulp Profili / Aluminium Handle Profile	Eloksal / Mat Anodized	mt.	-	-	-	2,5
150-2524-1410	Alüminyum Kapama Profili / Aluminium Closure Profile	Eloksal / Mat Anodized	mt.	-	-	-	2,5
150-1420-1420	Alüminyum Kapama Profili / Aluminium Closure Profile	Parlak / Bright	mt.	-	-	-	3,0
150-2930-1420	Alüminyum Orta Kayıt / Aluminium Horizontal Central	Parlak / Bright	mt.	-	-	-	3,0

Multiline 7055

103-7055

60 KG AYARLI SÜRME KAPAK SİSTEMİ
60 KG ADJUSTABLE SLIDING DOOR SYSTEM

Özel Üretim
Special Production

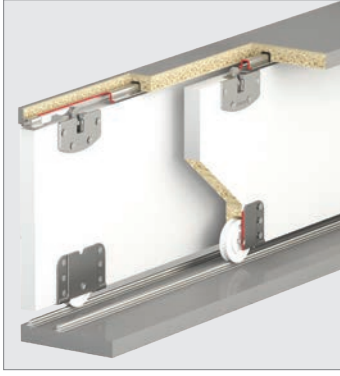

Bilgi / Information

- 1 Kutu İçeriği : 2 Kapak Mekanizma
- In 1 box : 2 Doors Mechanism

Yavaşlatıcı Alternatifi / Soft Closer Alternative

117-6942-1610 ► 117-6666-1610 ► 117-6710-1610 ►



103-7055 1 Takım İçeriği / 1 Kit Includes

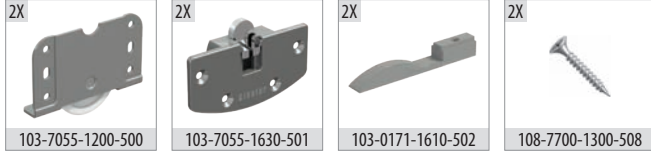

Ray Profilleri / Rail Profiles

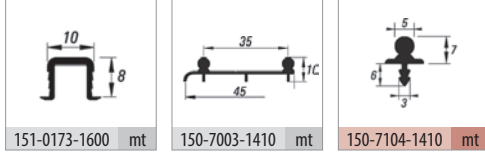

Kulp Profilleri / Handle Profiles

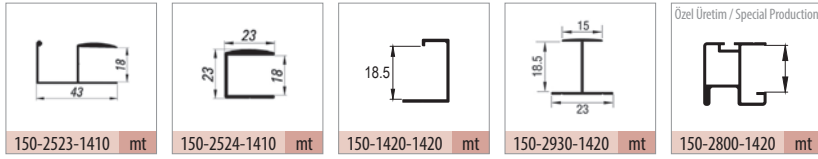

Teknik Detay / Technical Detail

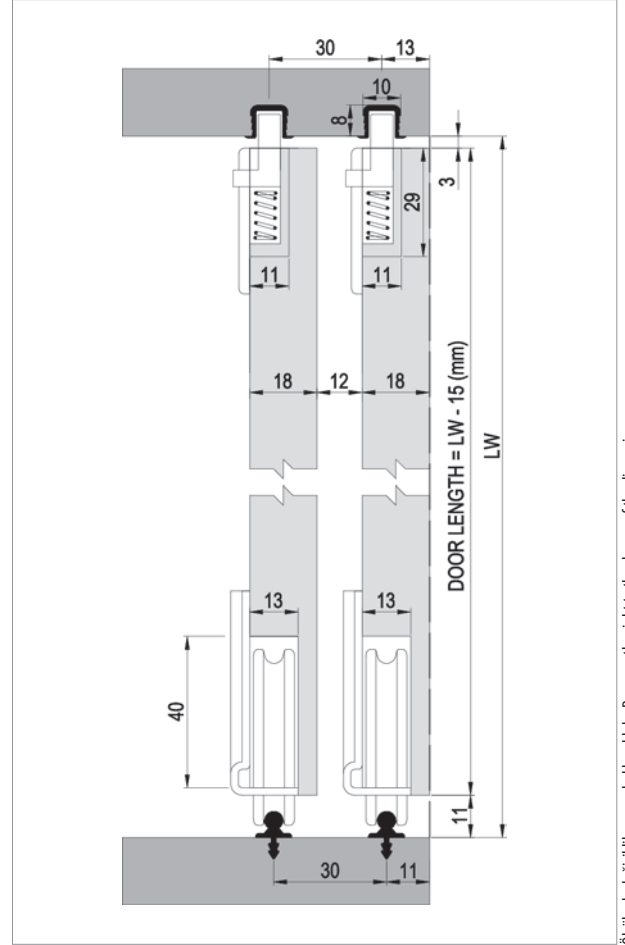

Ölçülerde değişiklik yapma hakkı saklıdır. Reserves the right to the change of the dimensions.

Kod / Code No	Açıklama / Description	Renk / Colour	Birim / Unit			Profil mt. / Profiles mt.	Bağ / Bnd.
103-7055-1200	60 Kg Sürme Kapak Sistemi / 60 Kg Sliding Door System	Silver	1 Kapak / 1 Kit	48	1.152	-	-
151-0173-1600	PVC Üst Ray Profili / PVC Top Rail Profile	Gri / Grey	mt.	-	-	-	3,0
150-7003-1410	Alüminyum Alt Ray Profili / Aluminium Bottom Rail Profile	Eloksal / Mat Anodized	mt.	-	-	2,0	3,0
150-7104-1410	Alüminyum Alt Ray Profili / Aluminium Bottom Rail Profile	Eloksal / Mat Anodized	mt.	-	-	-	3,0
150-2523-1410	Alüminyum Kulp Profili / Aluminium Handle Profile	Eloksal / Mat Anodized	mt.	-	-	-	2,5
150-2524-1410	Alüminyum Kapama Profili / Aluminium Closure Profile	Eloksal / Mat Anodized	mt.	-	-	-	2,5
150-1420-1420	Alüminyum Kapama Profili / Aluminium Closure Profile	Parlak / Bright	mt.	-	-	-	3,0
150-2930-1420	Alüminyum Orta Kayıt / Aluminium Horizontal Central	Parlak / Bright	mt.	-	-	-	3,0

Multiline 6400

103-6400

45 KG AYARLI SÜRME KAPAK SİSTEMİ
45 KG ADJUSTABLE SLIDING DOOR SYSTEM

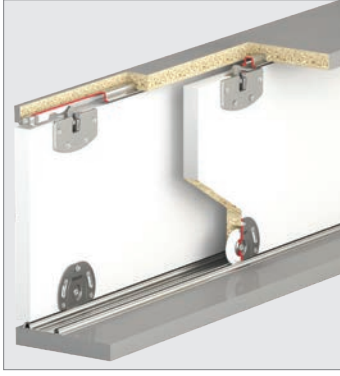

Bilgi / Information

- 1 Kutu İçeriği : 4 Kapak Mekanizma
- In 1 box : 4 Door Mechanism



Yavaşlatıcı Alternatifi / Soft Closer Alternative

117-6942-1610 ► 117-6666-1610 ► 117-6710-1610 ►

103-6400 1 Takım İçeriği / 1 Kit Includes

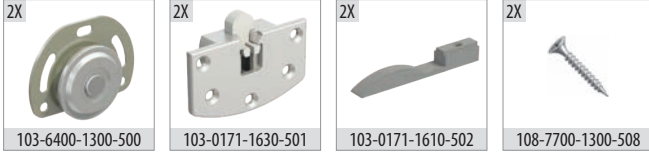

Ray Profilleri / Rail Profiles

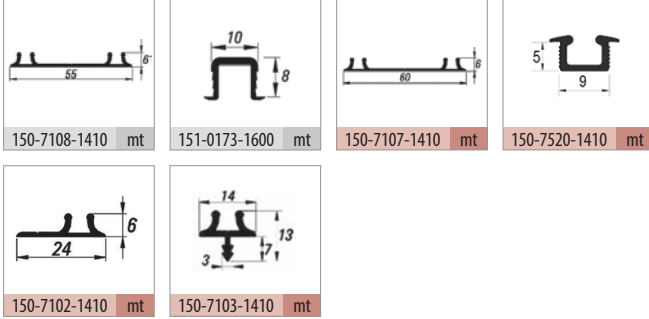

Kulp Profilleri / Handle Profiles

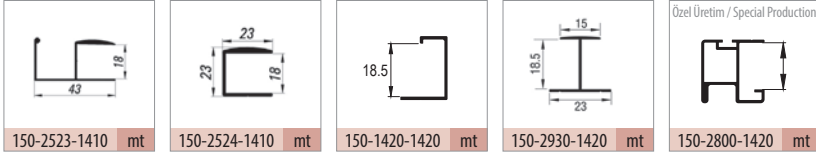

Opsiyonel Aksesuar / Optional Accessories



Teknik Detay / Technical Detail

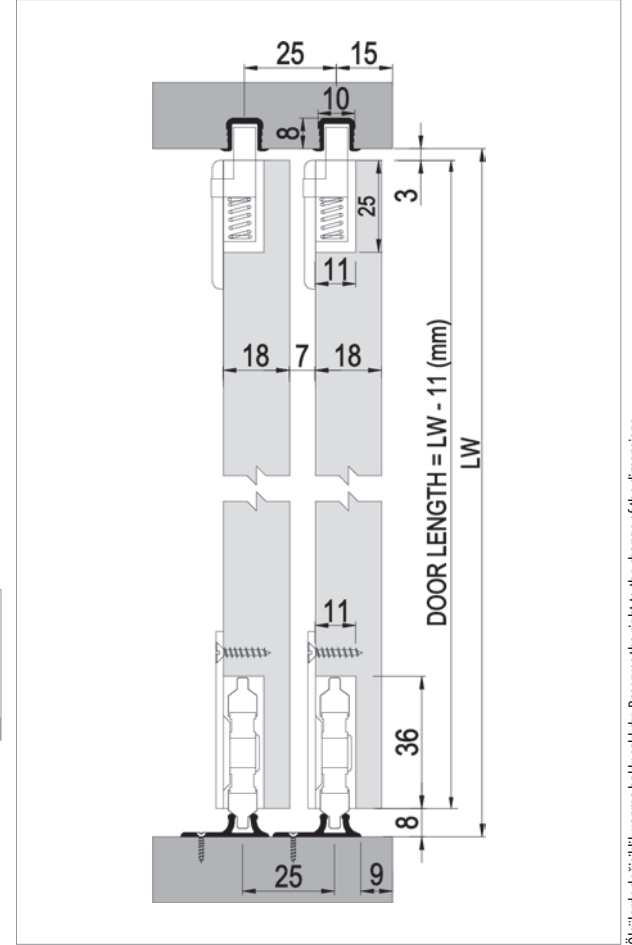

Ölçülerde değişiklik yapma hakkı saklıdır. Reserves the right to the change of the dimensions.

Kod / Code No	Açıklama / Description	Renk / Colour	Birim / Unit			Profil mt. / Profiles mt.			Bağ / Bnd.
103-6400-1300	45 Kg Sürme Kapak Sistemi / 45 Kg Sliding Door System	Galvaniz / Galvanized	1 Kapak / 1 Kit	96	2.304	-	-	-	-
150-7108-1410	Alüminyum Alt Ray Profili / Aluminium Bottom Rail Profile	Eloksal / Mat Anodized	mt.	-	-	2,0	2,5	3,0	12 ad/pcs
151-0173-1600	PVC Üst Ray Profili / PVC Top Rail Profile	Gri / Grey	mt.	-	-	-	-	3,0	50 ad/pcs
150-7107-1410	Alüminyum Alt Ray Profili / Aluminium Bottom Rail Profile	Eloksal / Mat Anodized	mt.	-	-	2,0	-	3,0	12 ad/pcs
150-7520-1410	Alüminyum Alt Ray Profili / Aluminium Bottom Rail Profile	Eloksal / Mat Anodized	mt.	-	-	-	-	3,0	30 ad/pcs
150-7102-1410	Alüminyum Alt Ray Profili / Aluminium Bottom Rail Profile	Eloksal / Mat Anodized	mt.	-	-	-	-	3,0	20 ad/pcs
150-7103-1410	Alüminyum Alt Ray Profili / Aluminium Bottom Rail Profile	Eloksal / Mat Anodized	mt.	-	-	-	-	3,0	30 ad/pcs
150-2523-1410	Alüminyum Kulp Profili / Aluminium Handle Profile	Eloksal / Mat Anodized	mt.	-	-	-	2,5	3,0	10 ad/pcs
150-2524-1410	Alüminyum Kapama Profili / Aluminium Closure Profile	Eloksal / Mat Anodized	mt.	-	-	-	2,5	3,0	10 ad/pcs
150-1420-1420	Alüminyum Kapama Profili / Aluminium Closure Profile	Parlak / Bright	mt.	-	-	-	-	3,0	10 ad/pcs
150-2930-1420	Alüminyum Orta Kayıt / Aluminium Horizontal Central	Parlak / Bright	mt.	-	-	-	-	3,0	10 ad/pcs

Multiline 7040

103-7040

40 KG HAFİF SÜRME KAPAK SİSTEMİ
40 KG LIGHT SLIDING DOOR SYSTEM



■ Yavaşlatıcı Alternatifi / Soft Closer Alternative

117-6942-1610 ► 117-6666-1610 ► 117-6710-1610 ►



■ 103-7040 1 Takım İçeriği / 1 Kit Includes

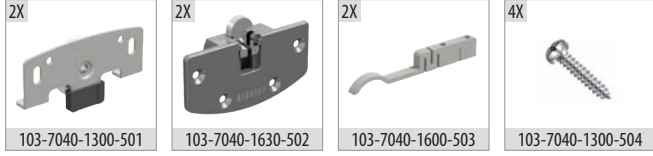

■ Ray Profilleri / Rail Profiles

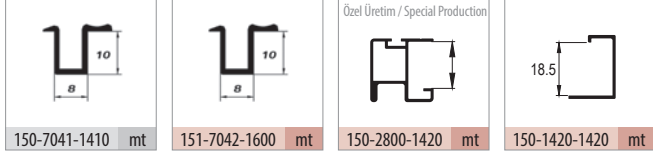

■ Kulp Profilleri / Handle Profiles

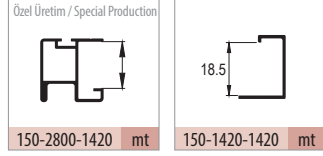

■ Teknik Detay / Technical Detail

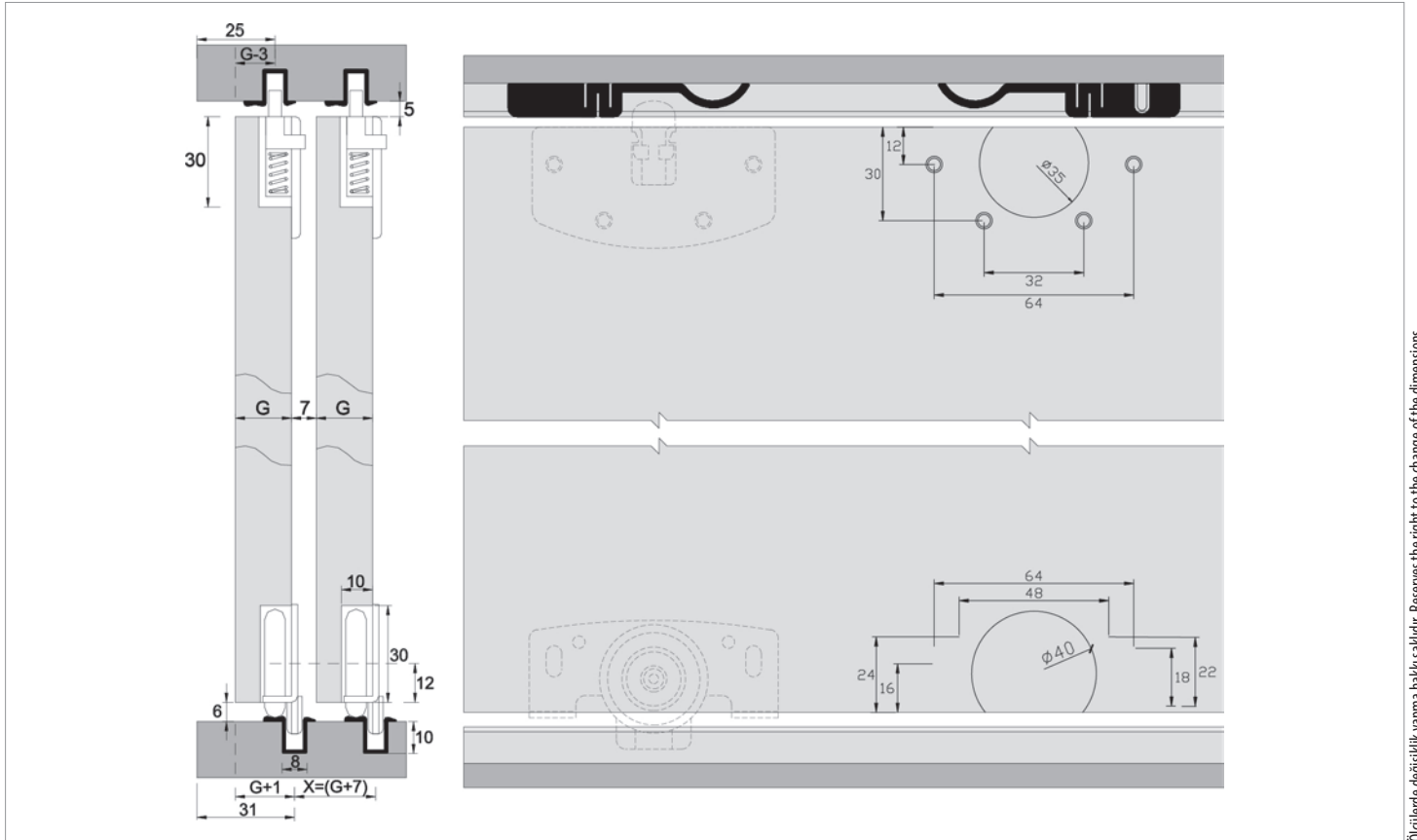

Ölçülerde değişiklik yapma hakkı saklıdır. Reserves the right to the change of the dimensions.

Kod / Code No	Açıklama / Description	Renk / Colour	Birim / Unit			Profil mt. / Profiles mt.	Bağ / Bnd.
103-7040-1300	40 Kg Sürme Kapak Sistemi / 40 Kg Sliding Door System	Galvaniz / Galvanized	1 Kapak / 1 Kit	100	1.800	- - -	-
150-7041-1410	Alüminyum Alt - Üst Ray Profili / Aluminium Top - Bottom Rail Profile	Eloksal / Mat Anodized	mt.	-	-	- - 3,0	50 ad/pcs
151-7042-1600	PVC Alt - Üst Ray Profili / PVC Top - Bottom Rail Profile	Gri / Grey	mt.	-	-	- - 3,0	50 ad/pcs
150-2800-1420	Alüminyum Kulp Profili / Aluminium Handle Profile	Parlak / Bright	mt.	-	-	- - 3,0	6 ad/pcs
150-1420-1420	Alüminyum Kapama Profili / Aluminium Closure Profile	Parlak / Bright	mt.	-	-	- - 3,0	10 ad/pcs

Multiline 7045

103-7045

45 KG HAFİF SÜRME KAPAK SİSTEMİ
45 KG LIGHT SLIDING DOOR SYSTEM



■ Yavaşlatıcı Alternatifi / Soft Closer Alternative

117-6942-1610 ► 117-6666-1610 ► 117-6710-1610 ►



■ 103-7045 1 Takım İçeriği / 1 Kit Includes

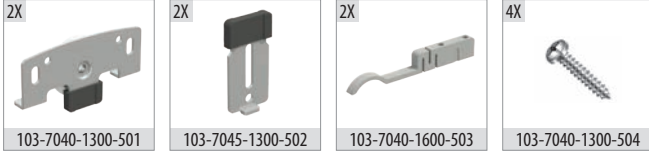

■ Ray Profilleri / Rail Profiles

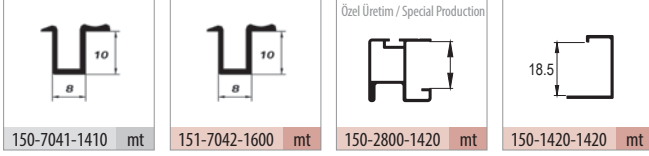

■ Kulp Profilleri / Handle Profiles

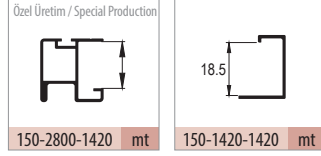

■ Teknik Detay / Technical Detail

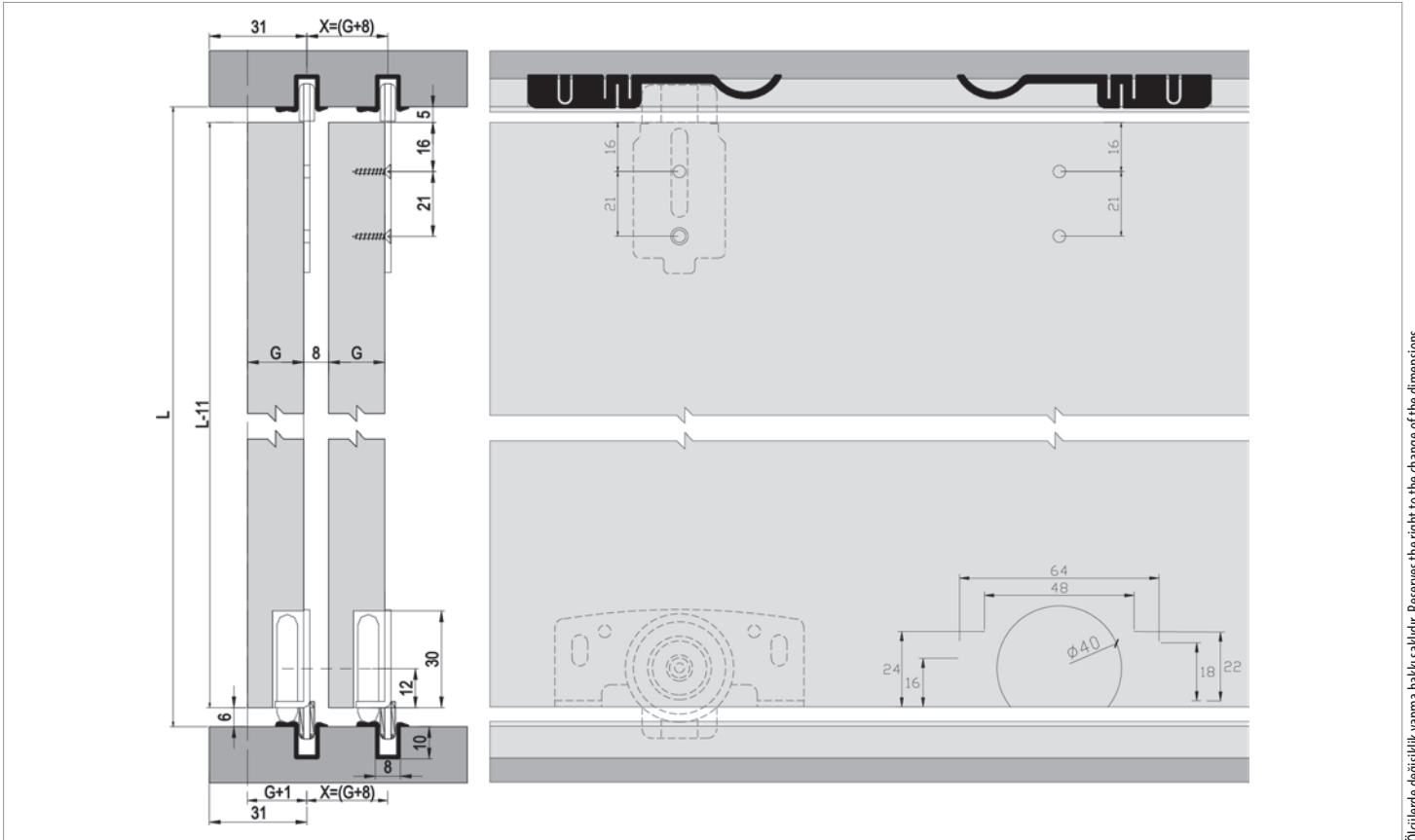

Ölçülerde değişiklik yapma hakkı saklıdır. Reserves the right to the change of the dimensions.

Kod / Code No	Açıklama / Description	Renk / Colour	Birim / Unit			Profil mt. / Profiles mt.	Bağ / Bnd.
103-7045-1300	45 Kg Sürme Kapak Sistemi / 45 Kg Sliding Door System	Galvaniz / Galvanized	1 Kapak / 1 Kit	100	1.800	- - -	-
150-7041-1410	Alüminyum Alt - Üst Ray Profili / Aluminium Top - Bottom Rail Profile	Eloksal / Mat Anodized	mt.	-	-	- - 3,0	50 ad/pcs
151-7042-1600	PVC Alt - Üst Ray Profili / PVC Top - Bottom Rail Profile	Gri / Grey	mt.	-	-	- - 3,0	50 ad/pcs
150-2800-1420	Alüminyum Kulp Profili / Aluminium Handle Profile	Parlak / Bright	mt.	-	-	- - 3,0	6 ad/pcs
150-1420-1420	Alüminyum Kapama Profili / Aluminium Closure Profile	Parlak / Bright	mt.	-	-	- - 3,0	10 ad/pcs

Multiline 6500

103-6500

15 KG AYARLI HAFİF SÜRME KAPAK SİSTEMİ
15 KG ADJUSTABLE LIGHT SLIDING DOOR SYSTEM

Özel Üretim
Special Production



■ Yavaşlatıcı Alternatifi / Soft Closer Alternative

117-6942-1610 ►►



■ 103-6500 1 Takım İçeriği / 1 Kit Includes

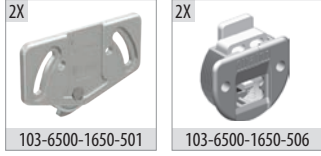

■ Ray Profilleri / Rail Profiles

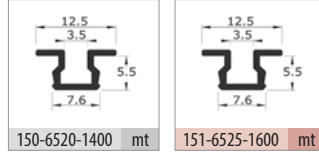

■ Kulp Profilleri / Handle Profiles

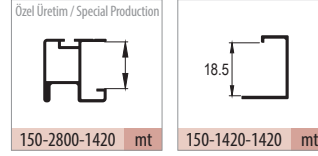

■ Teknik Detay / Technical Detail

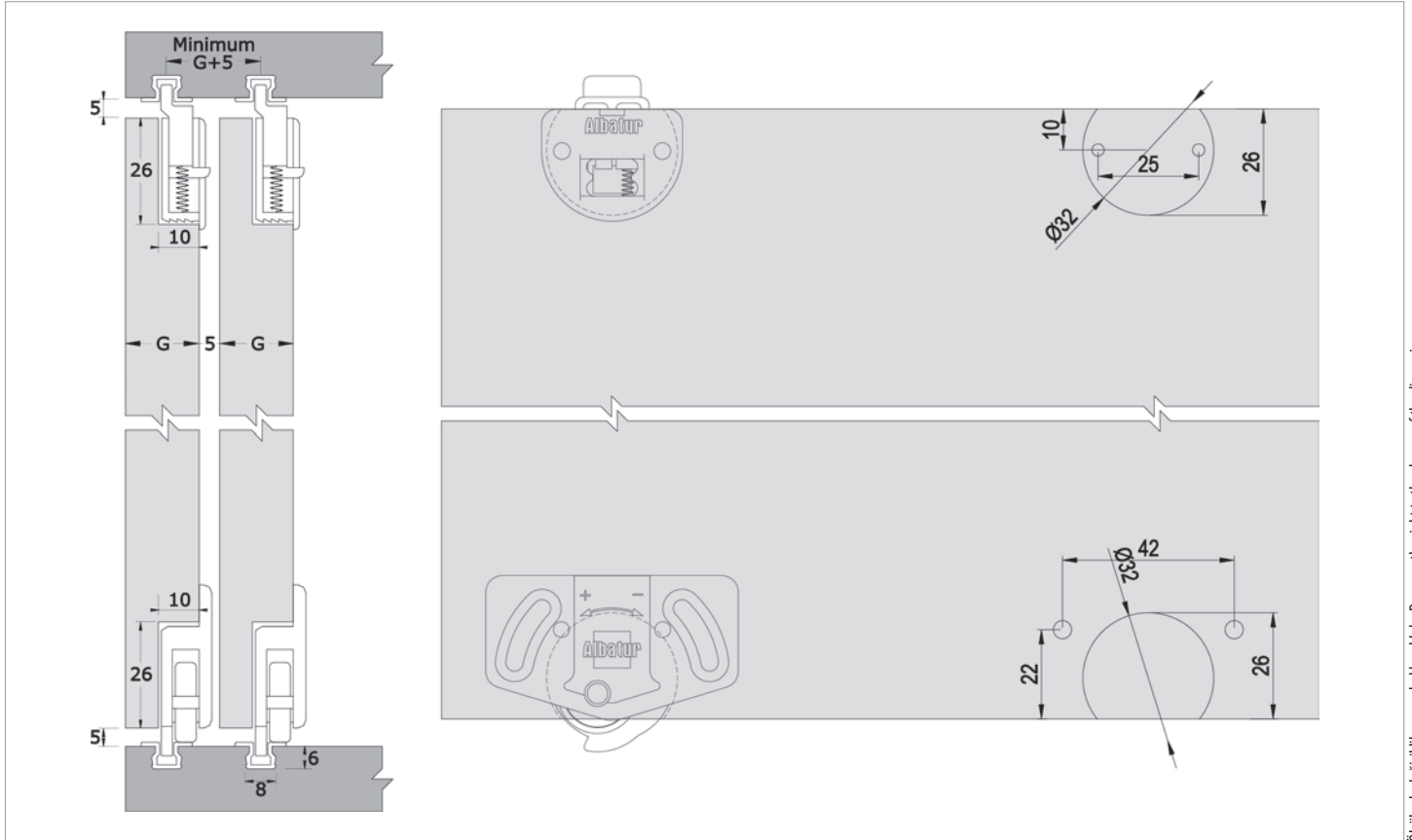

Ölçülerde değişiklik yapma hakkı saklıdır. Reserves the right to the change of the dimensions.

Kod / Code No	Açıklama / Description	Renk / Colour	Birim / Unit			Profil mt. / Profiles mt.	Bağ / Bnd.
103-6500-1630	15 Kg Sürme Kapak Sistemi / 15 Kg Sliding Door System	Siyah / Black	1 Kapak / 1 Kit	100	3.200	- - -	-
103-6500-1680	15 Kg Sürme Kapak Sistemi / 15 Kg Sliding Door System	Meşe / Oak	1 Kapak / 1 Kit	100	3.200	- - -	-
103-6500-1670	15 Kg Sürme Kapak Sistemi / 15 Kg Sliding Door System	Kahve/Brown	1 Kapak / 1 Kit	100	3.200	- - -	-
103-6500-1650	15 Kg Sürme Kapak Sistemi / 15 Kg Sliding Door System	Beyaz / White	1 Kapak / 1 Kit	100	3.200	- - -	-
103-6500-1600	15 Kg Sürme Kapak Sistemi / 15 Kg Sliding Door System	Gri / Grey	1 Kapak / 1 Kit	100	3.200	- - -	-
150-6520-1400	Alüminyum Ray Profili / Aluminium Rail Profile	Pres/ Uncoated	mt.	-	-	- -	3,0 30 ad/pcs
151-6525-1600	PVC Ray Profili / PVC Rail Profile	Gri / Grey	mt.	-	-	- -	3,0 30 ad/pcs
150-2800-1420	Alüminyum Kulp Profili / Aluminium Handle Profile	Parlak / Bright	mt.	-	-	- -	3,0 6 ad/pcs
150-1420-1420	Alüminyum Kapama Profili / Aluminium Closure Profile	Parlak / Bright	mt.	-	-	- -	3,0 10 ad/pcs

Multiline 6510

103-6510

15 KG AYARLI HAFİF SÜRME KAPAK SİSTEMİ
15 KG ADJUSTABLE LIGHT SLIDING DOOR SYSTEM



Yavaşlatıcı Alternatifi / Soft Closer Alternative

117-6942-1610



103-6510 1 Takım İçeriği / 1 Kit Includes

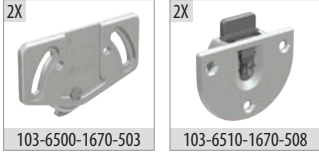

Ray Profilleri / Rail Profiles

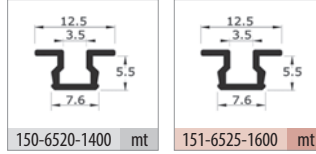

Kulp Profilleri / Handle Profiles

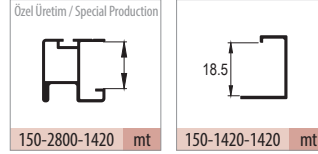

Teknik Detay / Technical Detail

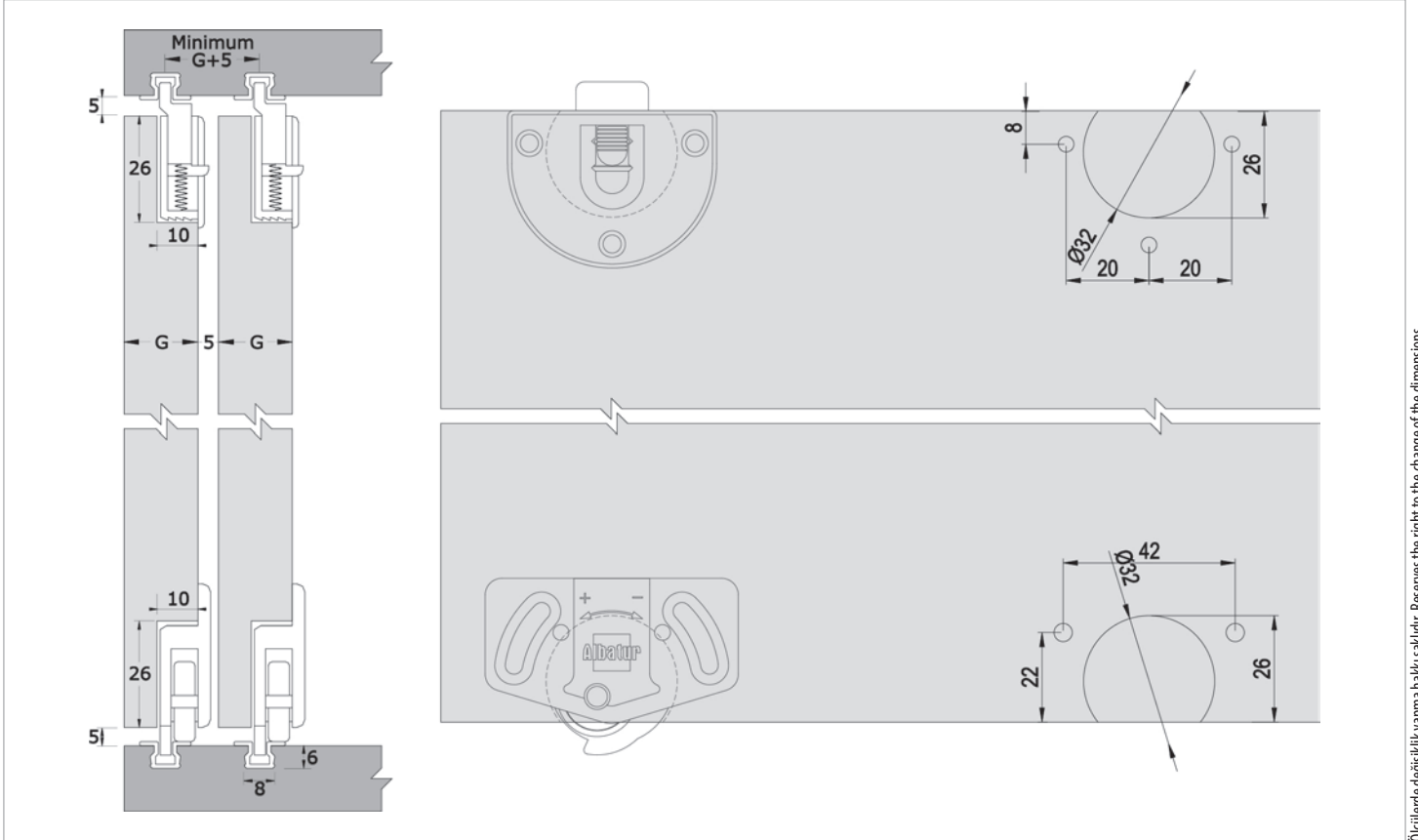

Ölçülerde değişiklik yapma hakkı saklıdır. Reserves the right to the change of the dimensions.

Kod / Code No	Açıklama / Description	Renk / Colour	Birim / Unit			Profil mt. / Profiles mt.			Bağ / Bnd.
103-6510-1670	15 Kg Sürme Kapak Sistemi / 15 Kg Sliding Door System	Kahve / Brown	1 Kapak / 1 Kit	100	3.200	-	-	-	-
150-6520-1400	Alüminyum Ray Profili / Aluminium Rail Profile	Pres/ Uncoated	mt.	-	-	-	-	3,0	30 ad/pcs
151-6525-1600	PVC Ray Profili / PVC Rail Profile	Gri / Grey	mt.	-	-	-	-	3,0	30 ad/pcs
150-2800-1420	Alüminyum Kulp Profili / Aluminium Handle Profile	Parlak / Bright	mt.	-	-	-	-	3,0	6 ad/pcs
150-1420-1420	Alüminyum Kapama Profili / Aluminium Closure Profile	Parlak / Bright	mt.	-	-	-	-	3,0	10 ad/pcs

Multiline 6000

103-6000

40 KG AYARLI SÜRME KAPAK SİSTEMİ
40 KG ADJUSTABLE SLIDING DOOR SYSTEM

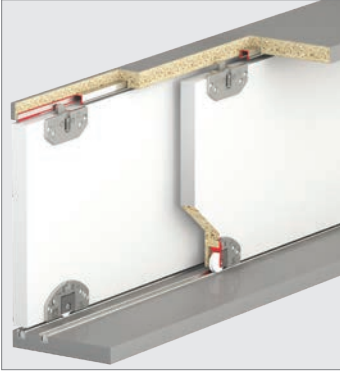

Bilgi / Information

- 1 Kutu İçeriği : 2 Kapak Mekanizma
- In 1 box : 2 Doors Mechanizma

Yavaşlatıcı Alternatifi / Soft Closer Alternative

117-6666-1610 ▶▶ 117-6710-1610 ▶▶



103-6000 1 Takım İçeriği / 1 Kit Includes

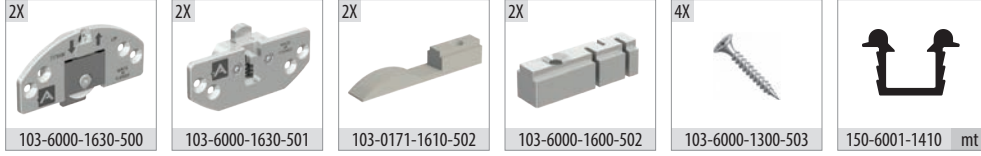

Ray Profilleri / Rail Profiles

Kulp Profilleri / Handle Profiles

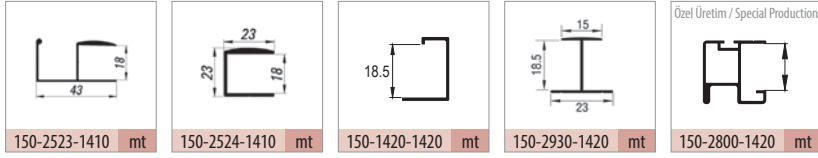

Teknik Detay / Technical Detail

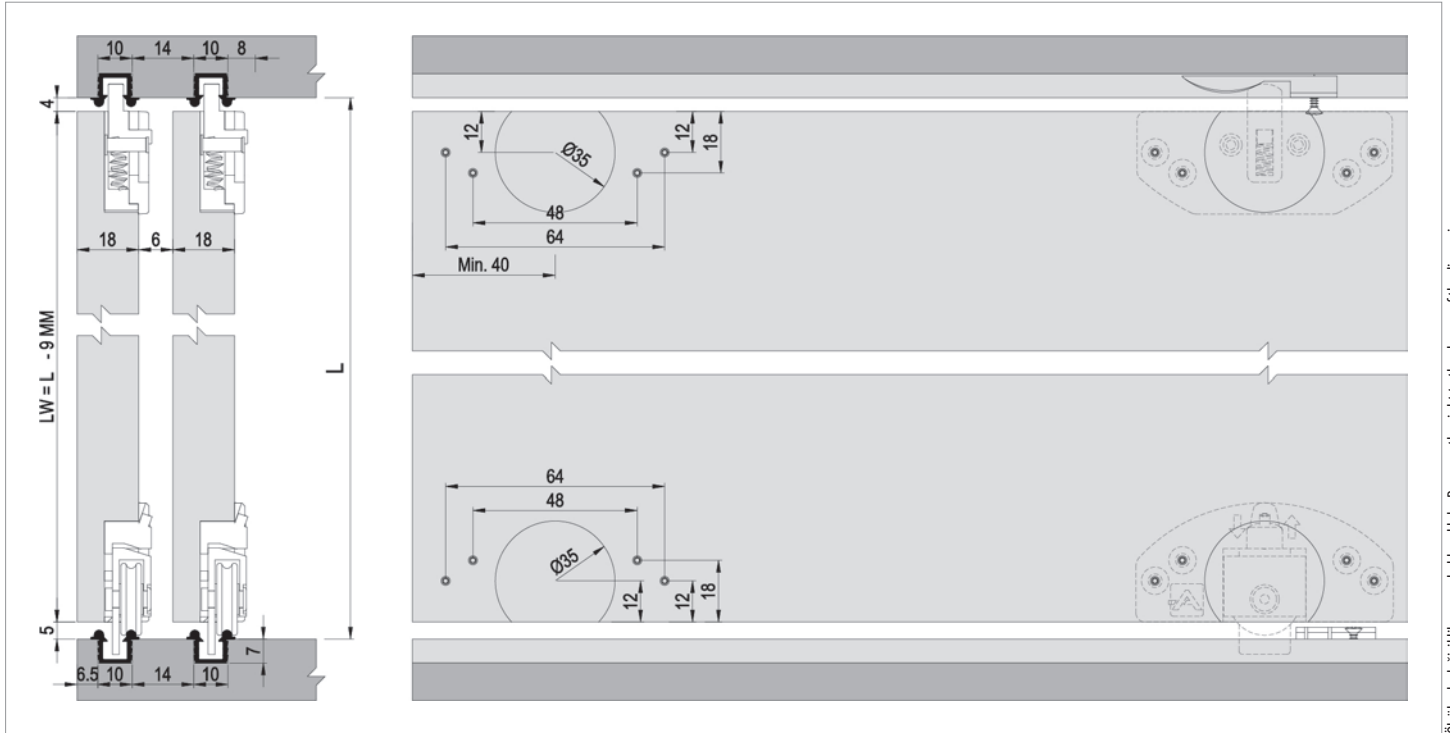

Ölçülerde değişiklik yapma hakkı saklıdır. Reserves the right to the change of the dimensions.

Kod / Code No	Açıklama / Description	Renk / Colour	Birim / Unit			Profil mt. / Profiles mt.	Bağ / Bnd.
103-6000-1630	40 Kg Sürme Kapak Sistemi / 40 Kg Sliding Door System	Siyah / Black	1 Kapak / 1 Kit	48	1.536	- - -	-
150-6001-1410	Alüminyum Ray Profili / Aluminium Rail Profile	Eloksal / Mat Anodized	mt.	-	-	- - 3,0	30 ad/pcs
150-2523-1410	Alüminyum Kulp Profili / Aluminium Handle Profile	Eloksal / Mat Anodized	mt.	-	-	- 2,5 3,0	10 ad/pcs
150-2524-1410	Alüminyum Kapama Profili / Aluminium Closure Profile	Eloksal / Mat Anodized	mt.	-	-	- 2,5 3,0	10 ad/pcs
150-1420-1420	Alüminyum Kapama Profili / Aluminium Closure Profile	Parlak / Bright	mt.	-	-	- - 3,0	10 ad/pcs
150-2930-1420	Alüminyum Orta Kayıt / Aluminium Horizontal Central	Parlak / Bright	mt.	-	-	- - 3,0	10 ad/pcs

Multiline 0171

103-0171

30 KG AYARLI SÜRME KAPAK SİSTEMİ
30 KG ADJUSTABLE SLIDING DOOR SYSTEM

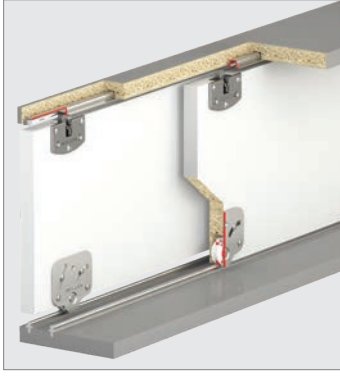

Bilgi / Information

- 1 Kutu İçeriği : 2 Kapak Mekanizma
- In 1 box : 2 Doors Mechanism

Yavaşlatıcı Alternatifi / Soft Closer Alternative

117-6942-1610 ► 117-6666-1610 ► 117-6710-1610 ►



103-0171 1 Takım İçeriği / 1 Kit Includes

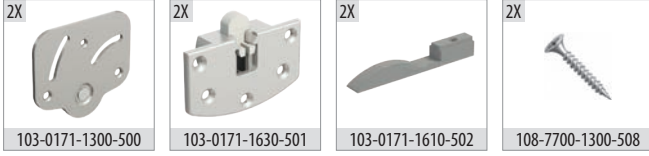

Ray Profilleri / Rail Profiles

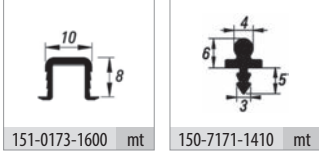

Kulp Profilleri / Handle Profiles

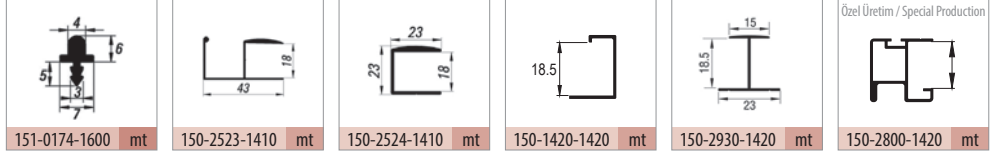

Teknik Detay / Technical Detail

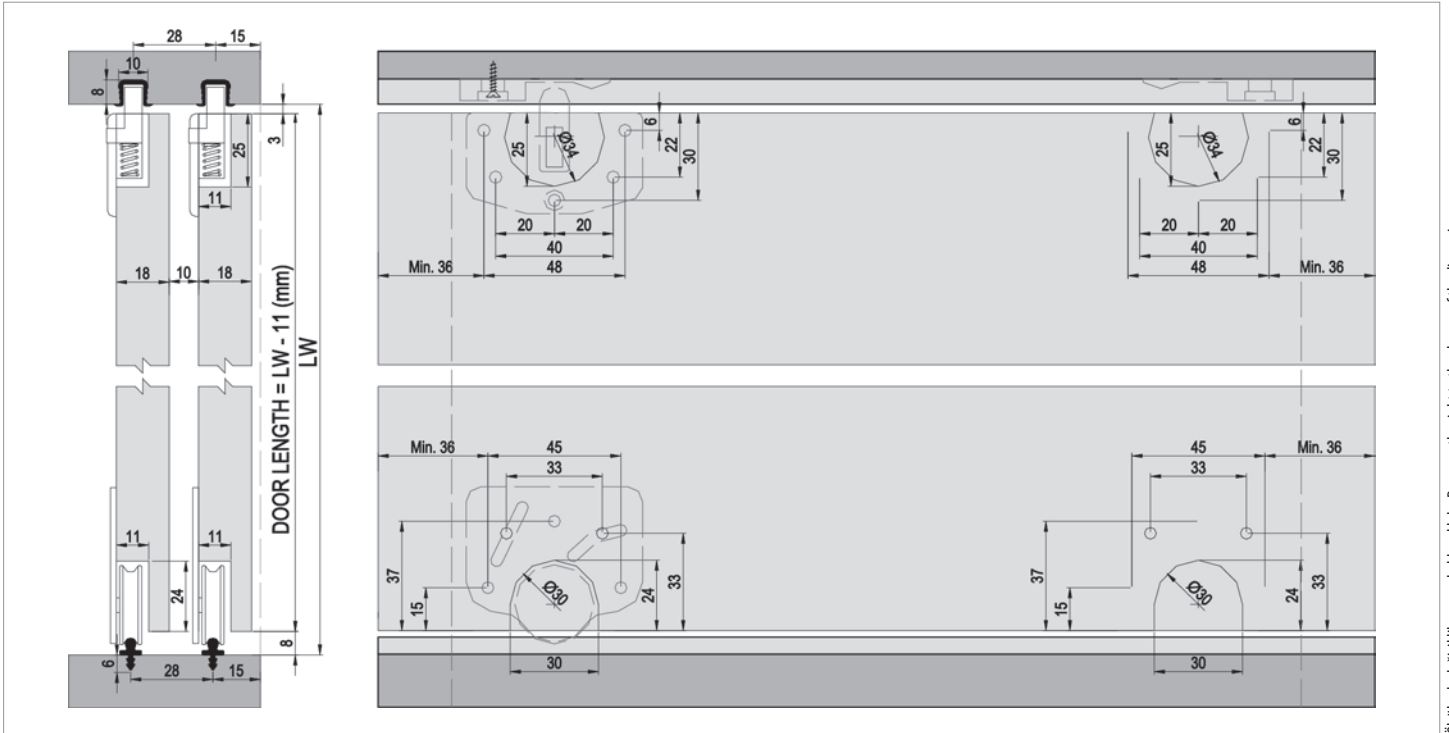

Ölçülerde değişiklik yapma hakkı saklıdır. Reserves the right to the change of the dimensions.

Kod / Code No	Açıklama / Description	Renk / Colour	Birim / Unit			Profil mt. / Profiles mt.	Bağ / Bnd.
103-0171-1300	30 Kg Sürme Kapak Sistemi / 30 Kg Sliding Door System	Galvaniz / Galvanized	1 Kapak / 1 Kit	100	3.200	-	-
151-0173-1600	PVC Ray Profili / PVC Rail Profile	Gri / Grey	mt.	-	-	-	3,0 50 ad/pcs
151-0174-1600	PVC Ray Profili / PVC Rail Profile	Gri / Grey	mt.	-	-	-	3,0 50 ad/pcs
150-7171-1410	Alüminyum Ray Profili / Aluminium Rail Profile	Eloksal / Mat Anodized	mt.	-	-	-	3,0 50 ad/pcs
150-2523-1410	Alüminyum Kulp Profili / Aluminium Handle Profile	Eloksal / Mat Anodized	mt.	-	-	2,5	3,0 10 ad/pcs
150-2524-1410	Alüminyum Kapama Profili / Aluminium Closure Profile	Eloksal / Mat Anodized	mt.	-	-	2,5	3,0 10 ad/pcs
150-1420-1420	Alüminyum Kapama Profili / Aluminium Closure Profile	Parlak / Bright	mt.	-	-	-	3,0 10 ad/pcs
150-2930-1420	Alüminyum Orta Kayıt / Aluminium Horizontal Central	Parlak / Bright	mt.	-	-	-	3,0 10 ad/pcs

Multiline 6600

103-6600

25 KG AYARLI SÜRME KAPAK SİSTEMİ
25 KG ADJUSTABLE SLIDING DOOR SYSTEM

Özel Üretim
Special Production



■ Yavaşlatıcı Alternatifi / Soft Closer Alternative

117-6666-1610 ►► 117-6710-1610 ►►



■ 103-6600 1 Takım İçeriği / 1 Kit Includes

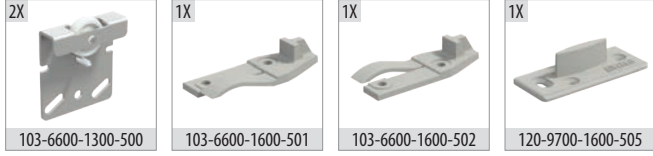

■ Ray Profilleri / Rail Profiles

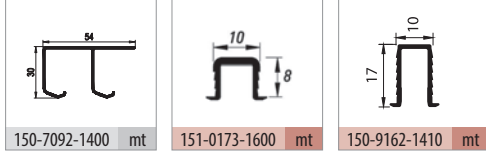

■ Teknik Detay / Technical Detail

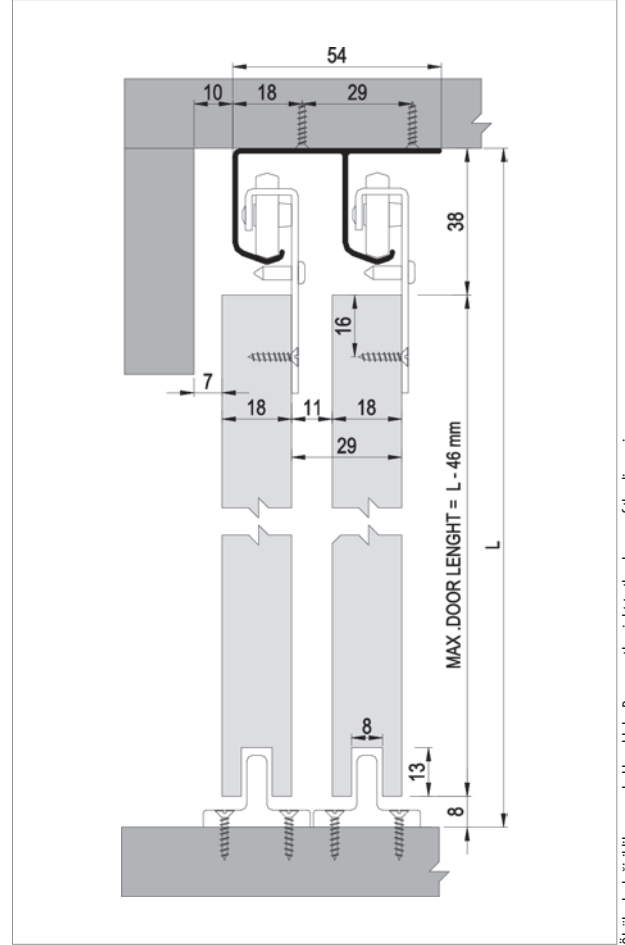

Ölçülerde değişiklik yapma hakkı saklıdır. Reserves the right to the change of the dimensions.

Kod / Code No	Açıklama / Description	Renk / Colour	Birim / Unit			Profil mt. / Profiles mt.			Bağ / Bnd.
103-6600-1300	25 Kg Sürme Kapak Sistemi / 25 Kg Sliding Door System	Galvaniz / Galvanized	1 Kapak / 1 Kit	30	960	-	-	-	-
150-7092-1400	Alüminyum Ray Profili / Aluminium Rail Profile	Pres / Uncoated	mt.	-	-	-	-	3,0	24 ad/pcs
151-0173-1600	PVC Ray Profili / PVC Rail Profile	Gri / Grey	mt.	-	-	-	-	3,0	50 ad/pcs
150-9162-1410	Alüminyum Alt Klavuz Profili / Aluminium Bottom Slider Profile	Eloksal / Mat Anodized	mt.	-	-	-	-	3,0	20 ad/pcs

Multiline 6320

103-6320

19 KG AYARLI SÜRME KAPAK SİSTEMİ
19 KG ADJUSTABLE SLIDING DOOR SYSTEM

Özel Üretim
Special Production



Yavaşlatıcı Alternatifi / Soft Closer Alternative

117-6940-1600 <<>> 117-6942-1610 <<>>



103-6320 1 Takım İçeriği / 1 Kit Includes

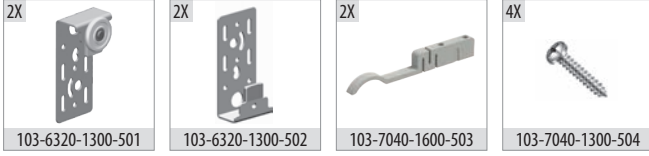

Ray Profilleri / Rail Profiles

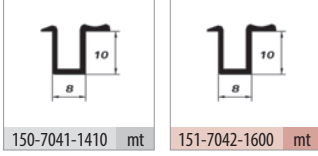

Kulp Profilleri / Handle Profiles

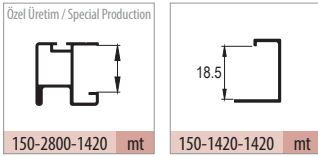

Uygulama / Application



Teknik Detay / Technical Detail

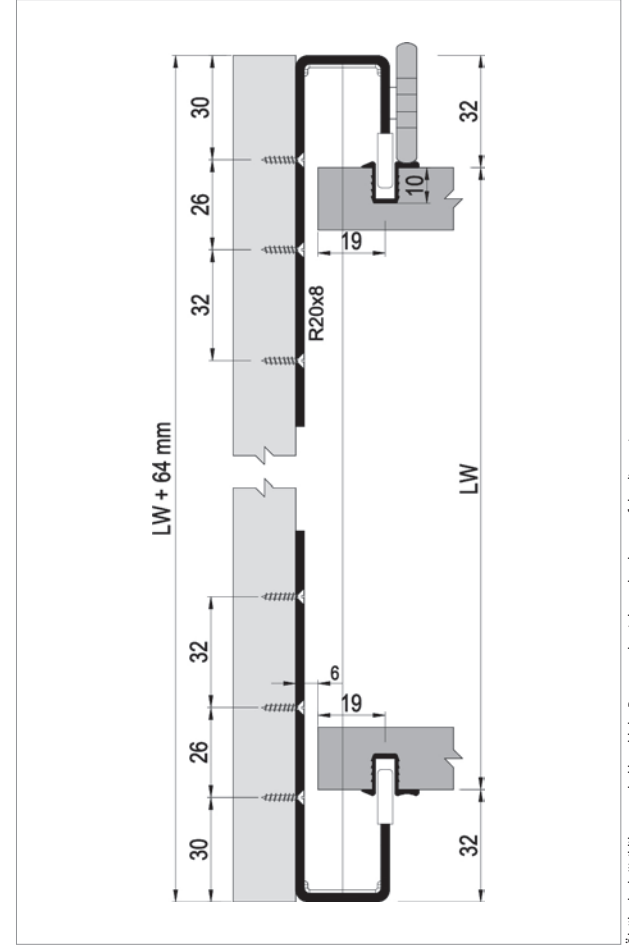

Ölçülerde değişiklik yapma hakkı saklıdır. Reserves the right to the change of the dimensions.

Kod / Code No	Açıklama / Description	Renk / Colour	Birim / Unit			Profil mt. / Profiles mt.	Bağ / Bnd.
103-6320-1300	19 Kg Sürme Kapak Sistemi / 19 Kg Sliding Door System	Galvaniz / Galvanized	1 Kapak / 1 Kit	24	576	- - -	-
150-7041-1410	Alüminyum Alt Ray Profili / Aluminium Bottom Rail Profile	Eloksal / Mat Anodized	mt.	-	-	- - 3,0	50 ad/pcs
151-7042-1600	PVC Üst Ray Profili / PVC Top Rail Profile	Gri / Grey	mt.	-	-	- - 3,0	50 ad/pcs
150-1420-1420	Alüminyum Kapama Profili / Aluminium Closure Profile	Parlak / Bright	mt.	-	-	- - 3,0	10 ad/pcs

Multiline 6100

103-6100

30 KG SÜRME KAPAK SİSTEMİ
30 KG SLIDING DOOR SYSTEM

Özel Üretim
Special Production



103-6100 1 Takım İçeriği / 1 Kit Includes

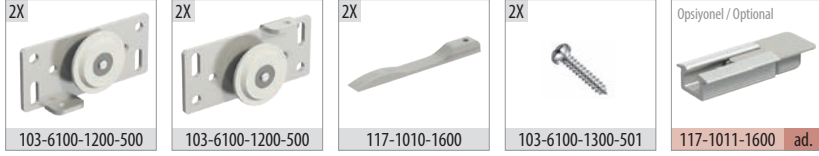

103-6120 1 Takım İçeriği / 1 Kit Includes

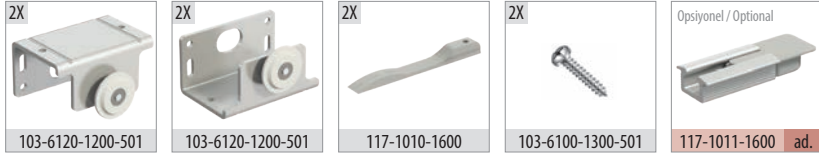

Ray Profilleri / Rail Profiles

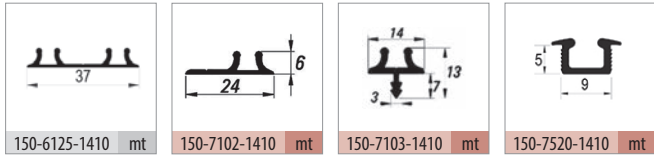

Uygulama / Application



Teknik Detay / Technical Detail

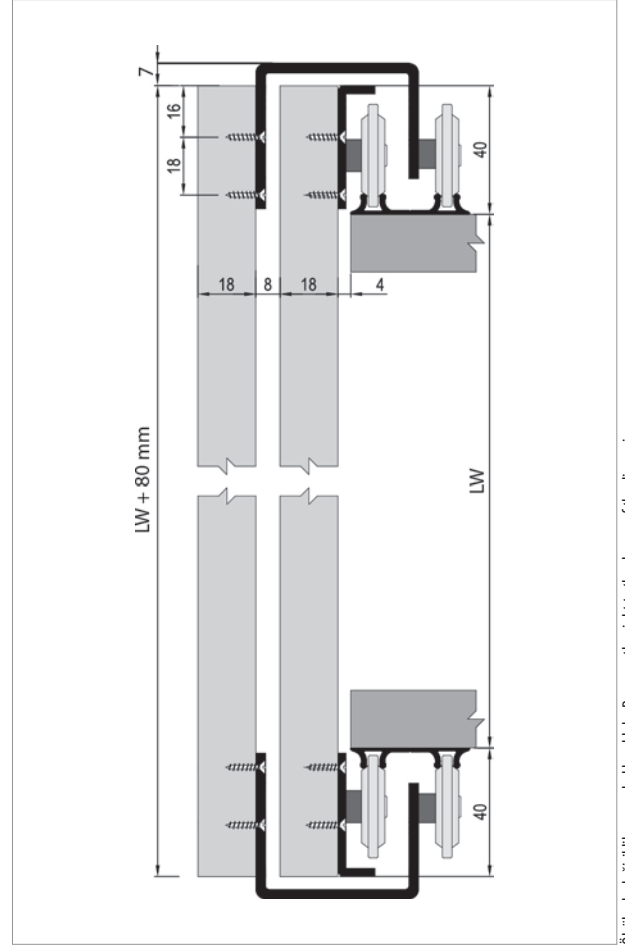

Ölçülerde değişiklik yapma hakkı saklıdır. Reserves the right to the change of the dimensions.

Kod / Code No	Açıklama / Description	Renk / Colour	Birim / Unit			Profil mt. / Profiles mt.	Bağ / Bnd.
103-6100-1200	30 Kg Sürme Kapak Sistemi İç Kapak / 30 Kg Sliding Door System Internal Door	Galvaniz / Galvanized	1 Kapak / 1 Kit	100	3200	- - -	-
103-6120-1200	30 Kg Sürme Kapak Sistemi Dış Kapak / 30 Kg Sliding Door System External Door	Galvaniz / Galvanized	1 Kapak / 1 Kit	24	576	- - -	-
150-6125-1410	Alüminyum Ray Profili / Aluminium Rail Profile	Eloksal / Mat Anodized	mt.	-	-	- - 3,0	24 ad/pcs
150-7520-1410	Alüminyum Ray Profili / Aluminium Rail Profile	Eloksal / Mat Anodized	mt.	-	-	- - 3,0	30 ad/pcs
150-7102-1410	Alüminyum Ray Profili / Aluminium Rail Profile	Eloksal / Mat Anodized	mt.	-	-	- - 3,0	20 ad/pcs
150-7103-1410	Alüminyum Ray Profili / Aluminium Rail Profile	Eloksal / Mat Anodized	mt.	-	-	- - 3,0	30 ad/pcs

Multiline 7601

103-7601

15 KG AYARLI SÜRME KAPAK SİSTEMİ
15 KG ADJUSTABLE SLIDING DOOR SYSTEM

Özel Üretim
Special Production



Yavaşlatıcı Alternatifi / Soft Closer Alternative

117-6940-1600 <<>> 117-6942-1610 <<>>



103-7601 1 Takım İçeriği / 1 Kit Includes



Ray Profilleri / Rail Profiles

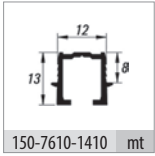

Uygulama / Application



Teknik Detay / Technical Detail

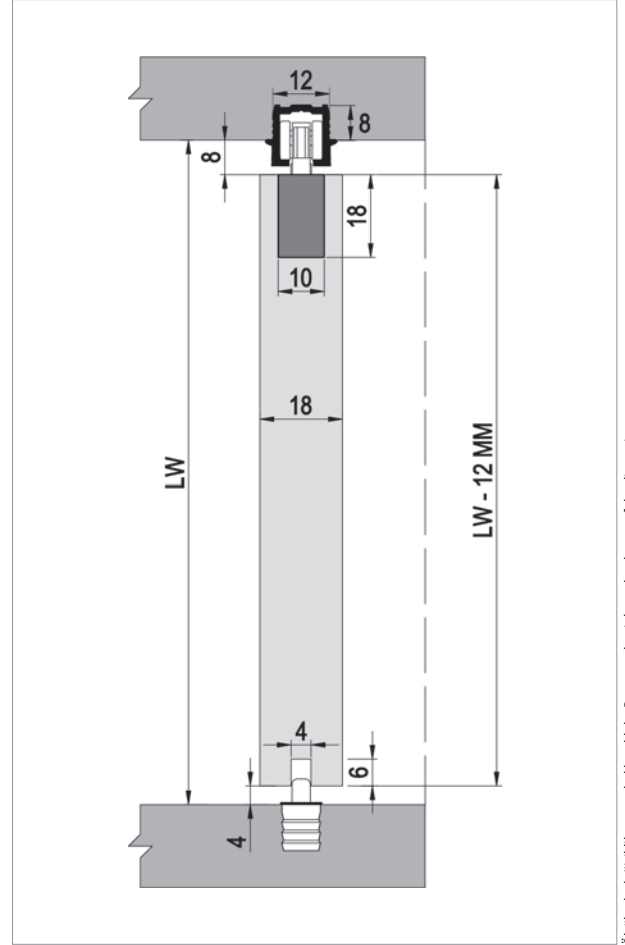

Ölçülerde değişiklik yapma hakkı saklıdır. Reserves the right to the change of the dimensions.

Kod / Code No	Açıklama / Description	Renk / Colour	Birim / Unit			Profil mt. / Profiles mt.	Bağ / Bnd.
103-7601-1600	15 Kg Sürme Kapak Sistemi / 15 Kg Sliding Door System	Gri / Grey	1 Kapak / 1 Kit	20	2.400	- - -	-
150-7610-1410	Alüminyum Üst Ray Profili / Aluminium Top Rail Profile	Eloksal / Mat Anodized	mt.	-	-	- - 3,0	10 ad/pcs

Group 105

WingSlide[®]

Sürme Katlanır Kapak Serisi

Sliding Foldable Door Series



Bu serideki tüm ürünleri incelemek için
QR kodu okutabilirsiniz.















You can analyze the QR code to see all the
products in these series.



WingSlide 744

<p>SINCE 1976</p>	 <p>Bearing Systems</p>	<p>EN 1527 100.000 CYCLES TEST</p> 	<p>R</p> <p>The Sliding System</p>
-----------------------	--	--	---



	OEM Kod OEM Code	Ürün Kodu Product Code	Sistem Tipi System Type	Panel Tipi Panel Type	Panel mm	Taşıma Kg Capacity Kg	Video	Üst Ray Upper Rail	Alt Ray Lower Rail	Kapak Adeti Number of Doors	Kapak Yükseklik Length of Door mm
1	105-7400	WingSlide 7400			18	25	✓	150-7450	150-7460	2	Max. 240
2	105-7405	WingSlide 7405			18	25		150-7445	150-7460	2	Max. 240
3	105-7410	WingSlide 7410			18	15		150-7460	150-7460	2	Max.150
4	105-7420	WingSlide 7420			18	40	✓	150-7450	150-7460	2	Max. 240
5	105-7430	WingSlide 7430			18	40	✓	150-7450	150-7460	2	Max. 240
6	105-7440	WingSlide 7440			18	40	✓	150-7445	150-7460	2	Max. 240
7	105-7441	WingSlide 7441			18	40	✓	150-7445	-	2	Max. 240

- Verilen ölçüler bağlayıcı değildir. Önerilen kurulum ölçüleridir. Albatır ürün özelliklerinde haber vermeden değişiklik yapabilir.
- The given dimension are not binding. These are recommended asamble dimensions. Albatır can make alteration to product specification without notice.

1



105-7400

2



105-7405

3



105-7410

4



105-7420

5



105-7430

6



105-7440

7

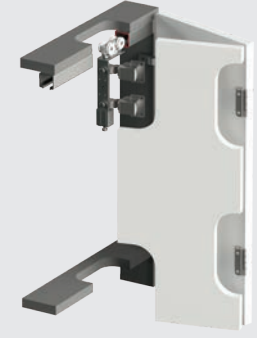

105-7441

8

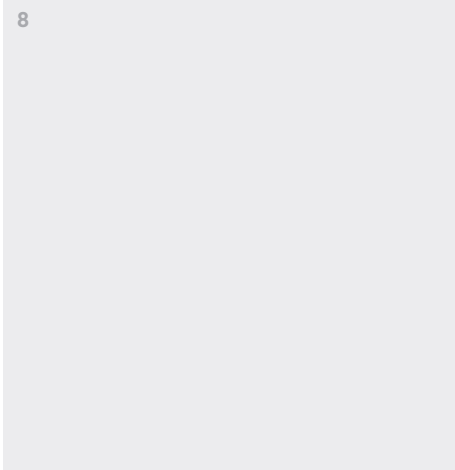

9

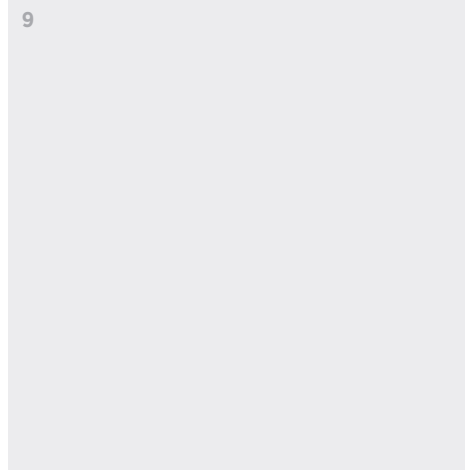

10

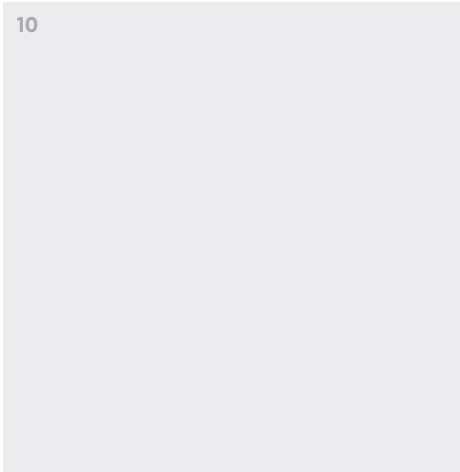

11

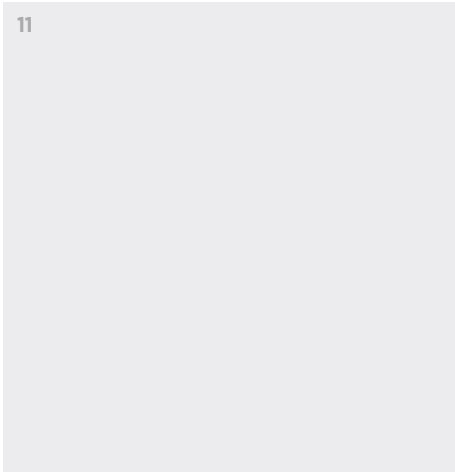

12

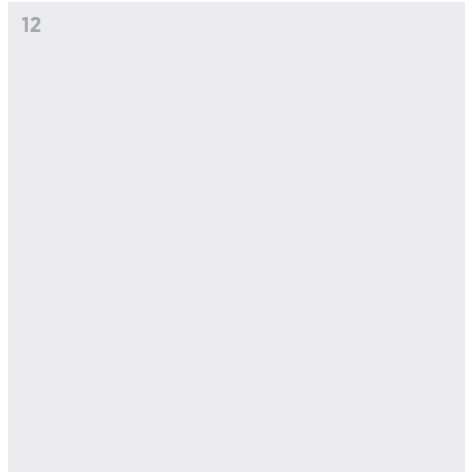

WingSlide 7400

105-7400

25 KG AYARLI KATLANIR SÜRME GARDIROP SİSTEMİ
25 KG ADJUSTABLE SLIDING SYSTEM FOR FOLDING DOORS



Bilgi / Information

- Maksimum kapak yüksekliği 240 cm önerilir.
- Maksimum 25 kg / 1 kapak
- Maksimum kapak eni 60 cm önerilir.
- Max. height of 240 cm
- Maximum 25 kg / 1 door
- Maximum width 60 cm

Yavaşlatıcı Alternatifi / Soft Closer Alternative

- Katlanır kapak sistemlerinde yavaşlatıcı için, yavaşlatıcı menteşe tercih edebilirsiniz.
- For foldable door systems with soft closing, you can prefer soft closing hinge.



105-7400 1 Takım İçeriği / 1 Kit Includes

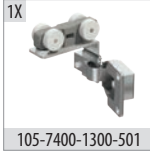

105-7400-1300-501

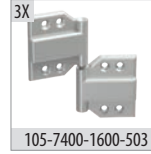

105-7400-1600-503

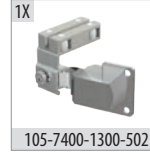

105-7400-1300-502

Ray Profilleri / Rail Profiles

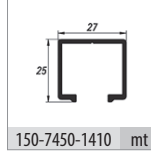

150-7450-1410 mt

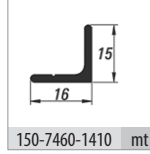

150-7460-1410 mt

Opsiyonel / Optional



105-7423-1300 ad.

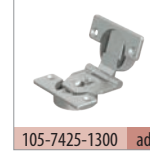

105-7425-1300 ad.

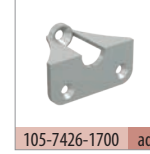

105-7426-1700 ad.

Teknik Detay / Technical Detail

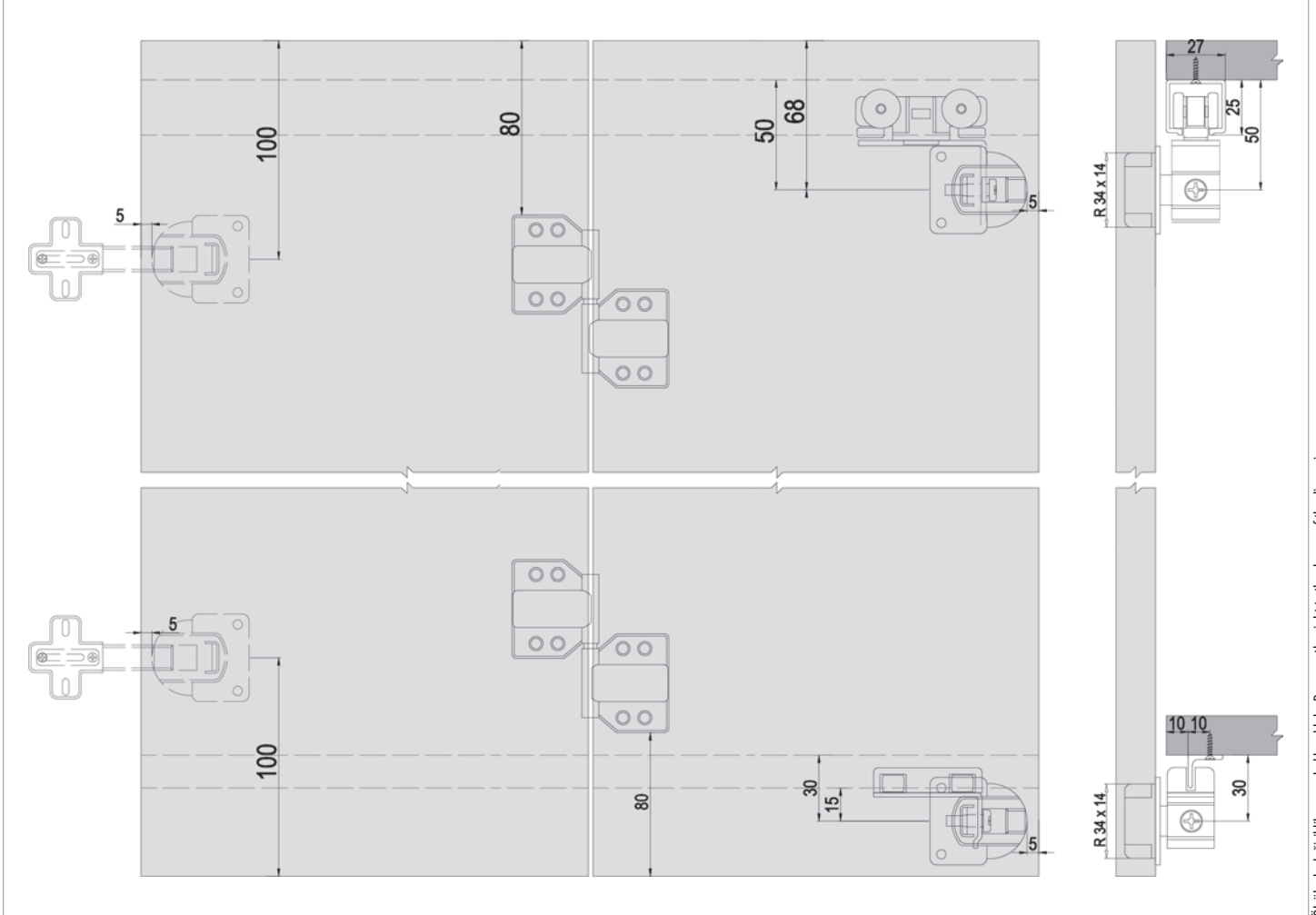

Ölçülerde değişiklik yapma hakkı saklıdır. Reserves the right to the change of the dimensions.

Kod / Code No	Açıklama / Description	Renk / Colour	Birim / Unit			Profil mt. / Profiles mt.	Bağ / Bnd.
105-7400-1300	25 Kg Katlanır Gardirop Sistem / 25 Kg Folding Wardrobe System	Galvaniz / Galvanized	1 Kapak / 1 Kit	24	768	-	-
105-7423-1300	Katlanır Kapak Sac Menteşe / Folding Door Sheet Iron Hinge	Galvaniz / Galvanized	1 Adet / 1 Pcs	250	-	-	-
105-7425-1300	Katlanır Kapak Zamak Menteşe / Folding Door Zinc Hinge	Galvaniz / Galvanized	1 Adet / 1 Pcs	240	-	-	-
105-7426-1700	Kulp Montaj Aparatı / Handle Assembly Kit	Gri / Grey	1 Adet / 1 Pcs	480	-	-	-
150-7450-1410	Alüminyum Üst Ray Profili / Aluminium Top Rail Profile	Eloksal / Mat Anodized	mt.	-	-	2,0	3,0
150-7460-1410	Alüminyum Alt Ray Profili / Aluminium Bottom Rail Profile	Eloksal / Mat Anodized	mt.	-	-	2,0	3,0



Bilgi / Information

- Maksimum kapak yüksekliği 240 cm önerilir.
- Maksimum 25 kg / 1 kapak
- Maksimum kapak eni 60 cm önerilir.
- Max. height of 240 cm
- Maximum 25 kg / 1 door
- Maximum width 60 cm

Yavaşlatıcı Alternatifi / Soft Closer Alternative

- Katlanır kapak sistemlerinde yavaşlatıcı için, yavaşlatıcı menteşe tercih edebilirsiniz.
- For foldable door systems with soft closing, you can prefer soft closing hinge.



105-7405 1 Takım İçeriği / 1 Kit Includes

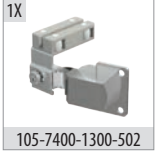
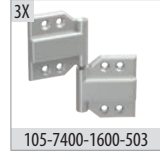
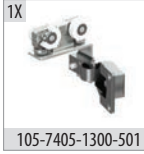

Ray Profilleri / Rail Profiles

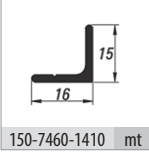
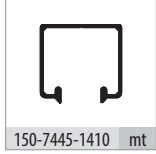

Opsiyonel / Optional

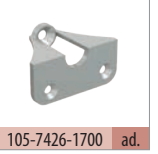
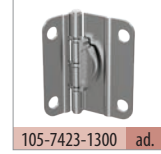

Teknik Detay / Technical Detail

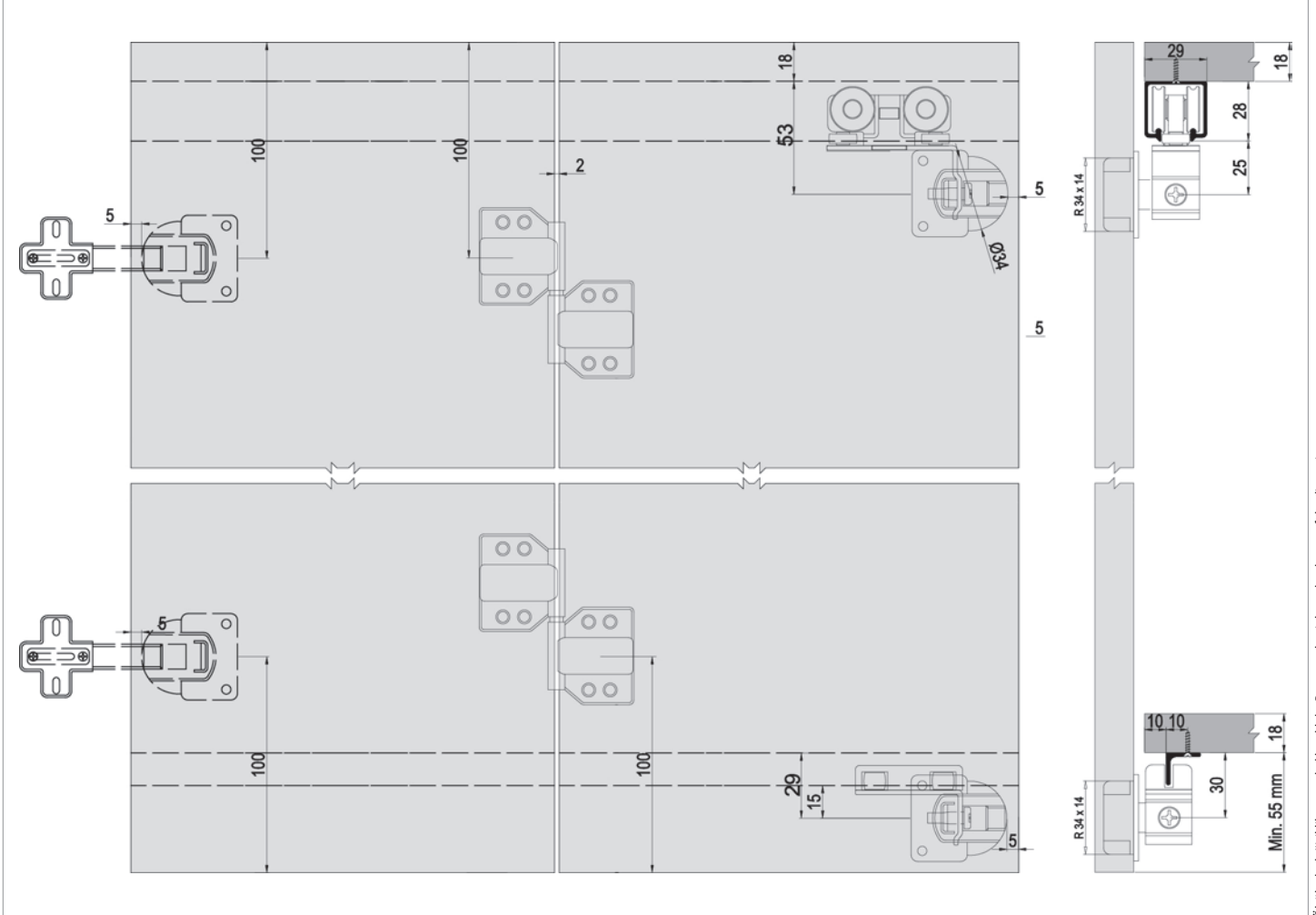

Ölçülerde değişiklik yapma hakkı saklıdır. Reserves the right to the change of the dimensions.

Kod / Code No	Açıklama / Description	Renk / Colour	Birim / Unit			Profil mt. / Profiles mt.	Bağ / Bnd.
105-7405-1300	25 Kg Katlanır Gardirop Sistem / 25 Kg Folding Wardrobe System	Galvaniz / Galvanized	1 Kapak / 1 Kit	24	768	-	-
105-7423-1300	Katlanır Kapak Sac Menteşe / Folding Door Sheet Iron Hinge	Galvaniz / Galvanized	1 Adet / 1 Pcs	250	-	-	-
105-7425-1300	Katlanır Kapak Zamak Menteşe / Folding Door Zinc Hinge	Galvaniz / Galvanized	1 Adet / 1 Pcs	240	-	-	-
105-7426-1700	Kulp Montaj Aparatı / Handle Assembly Kit	Gri / Grey	1 Adet / 1 Pcs	480	-	-	-
150-7445-1410	Alüminyum Üst Ray Profili / Aluminium Top Rail Profile	Eloksal / Mat Anodized	mt.	-	-	2,0	3,0
150-7460-1410	Alüminyum Alt Ray Profili / Aluminium Bottom Rail Profile	Eloksal / Mat Anodized	mt.	-	-	2,0	3,0

WingSlide 7410

105-7410

15 KG AYARLI KATLANIR SÜRME GARDIROP SİSTEMİ
15 KG ADJUSTABLE SLIDING SYSTEM FOR FOLDING DOORS

Özel Üretim
Special Production



Bilgi / Information

- Maksimum kapak yüksekliği 150 cm önerilir.
- Maksimum 15 kg / 1 kapak
- Maksimum kapak eni 50 cm önerilir.
- Max. height of 150 cm
- Maximum 15 kg / 1 door
- Maximum width 50 cm

Yavaşlatıcı Alternatifi / Soft Closer Alternative

- Katlanır kapak sistemlerinde yavaşlatıcı için, yavaşlatıcı menteşe tercih edebilirsiniz.
- For foldable door systems with soft closing, you can prefer soft closing hinge.



105-7410 1 Takım İçeriği / 1 Kit Includes

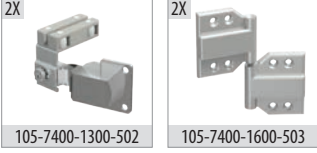

Ray Profilleri / Rail Profiles

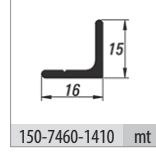

Opsiyonel / Optional



Teknik Detay / Technical Detail

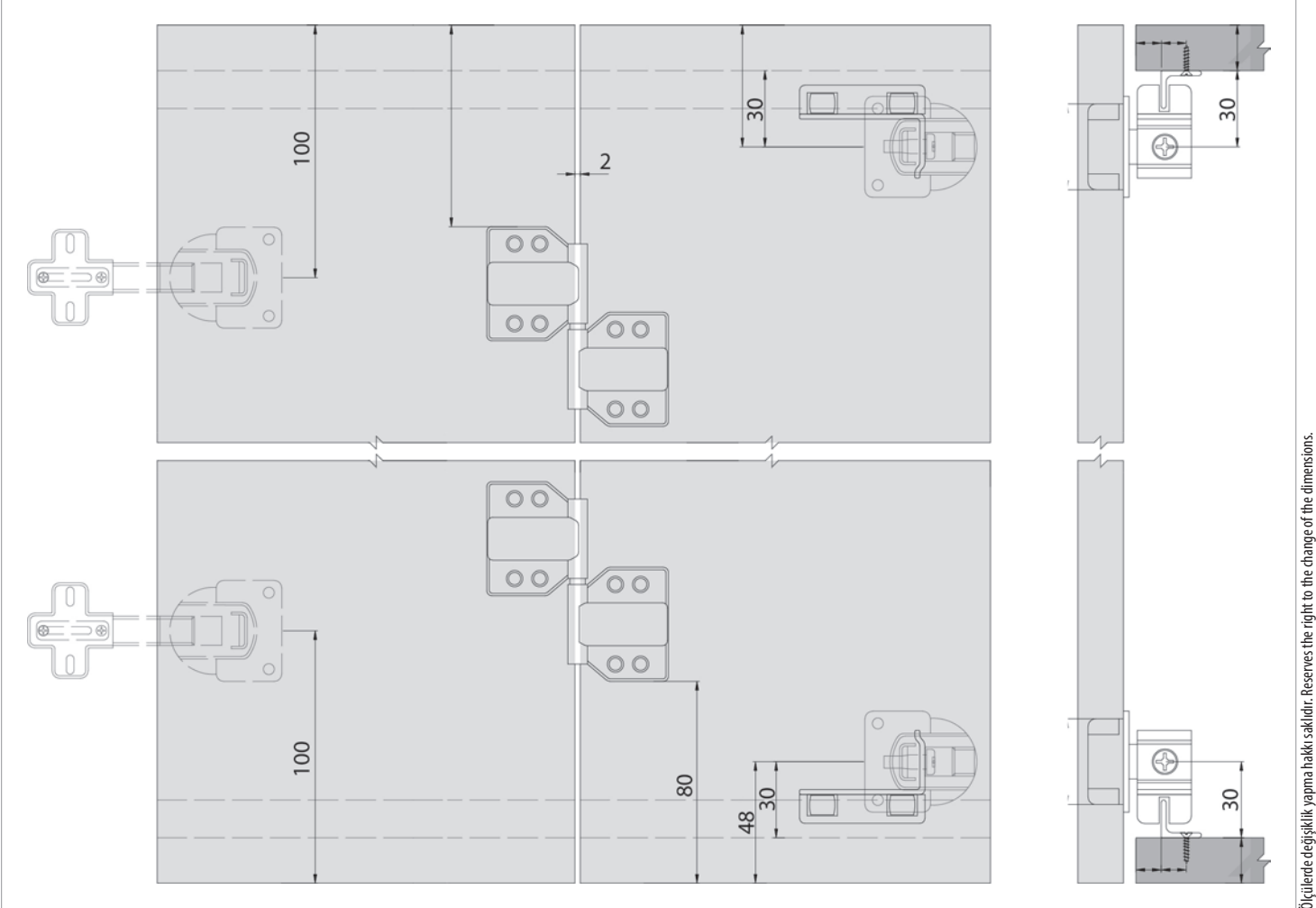

Ölçülerde değişiklik yapma hakkı saklıdır. Reserves the right to the change of the dimensions.

Kod / Code No	Açıklama / Description	Renk / Colour	Birim / Unit			Profil mt. / Profiles mt.	Bağ / Bnd.
105-7410-1300	25 Kg Katlanır Gardirop Sistem / 25 Kg Folding Wardrobe System	Galvaniz / Galvanized	1 Kapak / 1 Kit	24	768	- - -	-
105-7423-1300	Katlanır Kapak Sac Menteşe / Folding Door Sheet Iron Hinge	Galvaniz / Galvanized	1 Adet / 1 Pcs	250	-	- - -	-
105-7425-1300	Katlanır Kapak Zamak Menteşe / Folding Door Zinc Hinge	Galvaniz / Galvanized	1 Adet / 1 Pcs	240	-	- - -	-
105-7426-1700	Kulp Montaj Aparatı / Handle Assembly Kit	Gri / Grey	1 Adet / 1 Pcs	480	-	- - -	-
150-7460-1410	Alüminyum Alt Ray Profili / Aluminium Bottom Rail Profile	Eloksal / Mat Anodized	mt.	-	-	2,0 - 3,0	12 ad/pcs

WingSlide 7420

105-7420

40 KG AYARLI KATLANIR SÜRME GARDIROP SİSTEMİ
40 KG ADJUSTABLE SLIDING SYSTEM FOR FOLDING DOORS



Bilgi / Information

- Maksimum kapak yüksekliği 240 cm önerilir.
- Maksimum 40 kg / 1 kapak
- Maksimum kapak eni 60 cm önerilir.
- Max. height of 240 cm
- Maximum 40 kg / 1 door
- Maximum width 60 cm



Yavaşlatıcı Alternatifi / Soft Closer Alternative

- Katlanır kapak sistemlerinde yavaşlatıcı için, yavaşlatıcı menteşe tercih edebilirsiniz.
- For foldable door systems with soft closing, you can prefer soft closing hinge.

105-7420 1 Takım İçeriği / 1 Kit Includes



Ray Profilleri / Rail Profiles

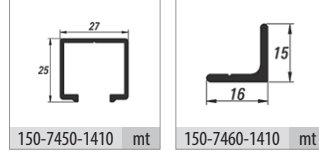

Opsiyonel / Optional



Teknik Detay / Technical Detail

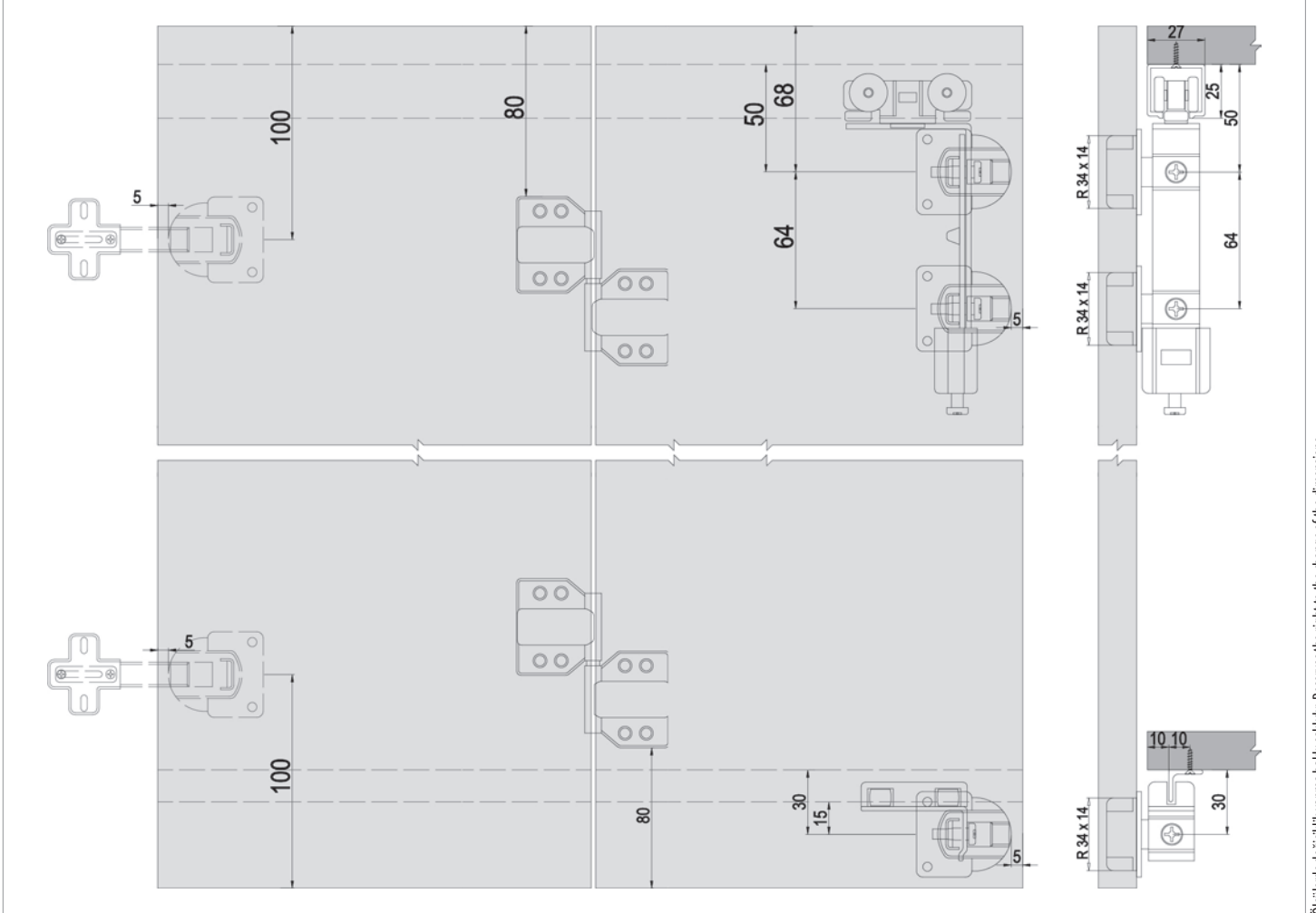

Ölçülerde değişiklik yapma hakkı saklıdır. Reserves the right to the change of the dimensions.

Kod / Code No	Açıklama / Description	Renk / Colour	Birim / Unit			Profil mt. / Profiles mt.	Bağ / Bnd.
105-7420-1300	40 Kg Katlanır Gardirop Sistem / 40 Kg Folding Wardrobe System	Galvaniz / Galvanized	1 Kapak / 1 Kit	24	576	-	-
105-7423-1300	Katlanır Kapak Sac Menteşe / Folding Door Sheet Iron Hinge	Galvaniz / Galvanized	1 Adet / 1 Pcs	250	-	-	-
105-7425-1300	Katlanır Kapak Zamak Menteşe / Folding Door Zinc Hinge	Galvaniz / Galvanized	1 Adet / 1 Pcs	240	-	-	-
105-7426-1700	Kulp Montaj Aparatı / Handle Assembly Kit	Gri / Grey	1 Adet / 1 Pcs	480	-	-	-
150-7450-1410	Alüminyum Üst Ray Profili / Aluminium Top Rail Profile	Eloksal / Mat Anodized	mt.	-	-	2,0	3,0
150-7460-1410	Alüminyum Alt Ray Profili / Aluminium Bottom Rail Profile	Eloksal / Mat Anodized	mt.	-	-	2,0	3,0

WingSlide 7430

105-7430

40 KG AYARLI KATLANIR SÜRME GARDIROP SİSTEMİ
40 KG ADJUSTABLE SLIDING SYSTEM FOR FOLDING DOORS



Bilgi / Information

- Maksimum kapak yüksekliği 240 cm önerilir.
- Maksimum 40 kg / 1 kapak
- Maksimum kapak eni 60 cm önerilir.
- Max. height of 240 cm
- Maximum 40 kg / 1 door
- Maximum width 60 cm

Yavaşlatıcı Alternatifi / Soft Closer Alternative

- Katlanır kapak sistemlerinde yavaşlatıcı için, yavaşlatıcı menteşe tercih edebilirsiniz.
- For foldable door systems with soft closing, you can prefer soft closing hinge.



105-7430 1 Takım İçeriği / 1 Kit Includes

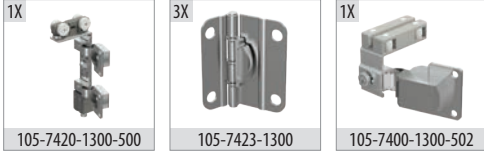

Ray Profilleri / Rail Profiles

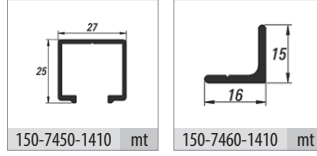

Opsiyonel / Optional



Teknik Detay / Technical Detail

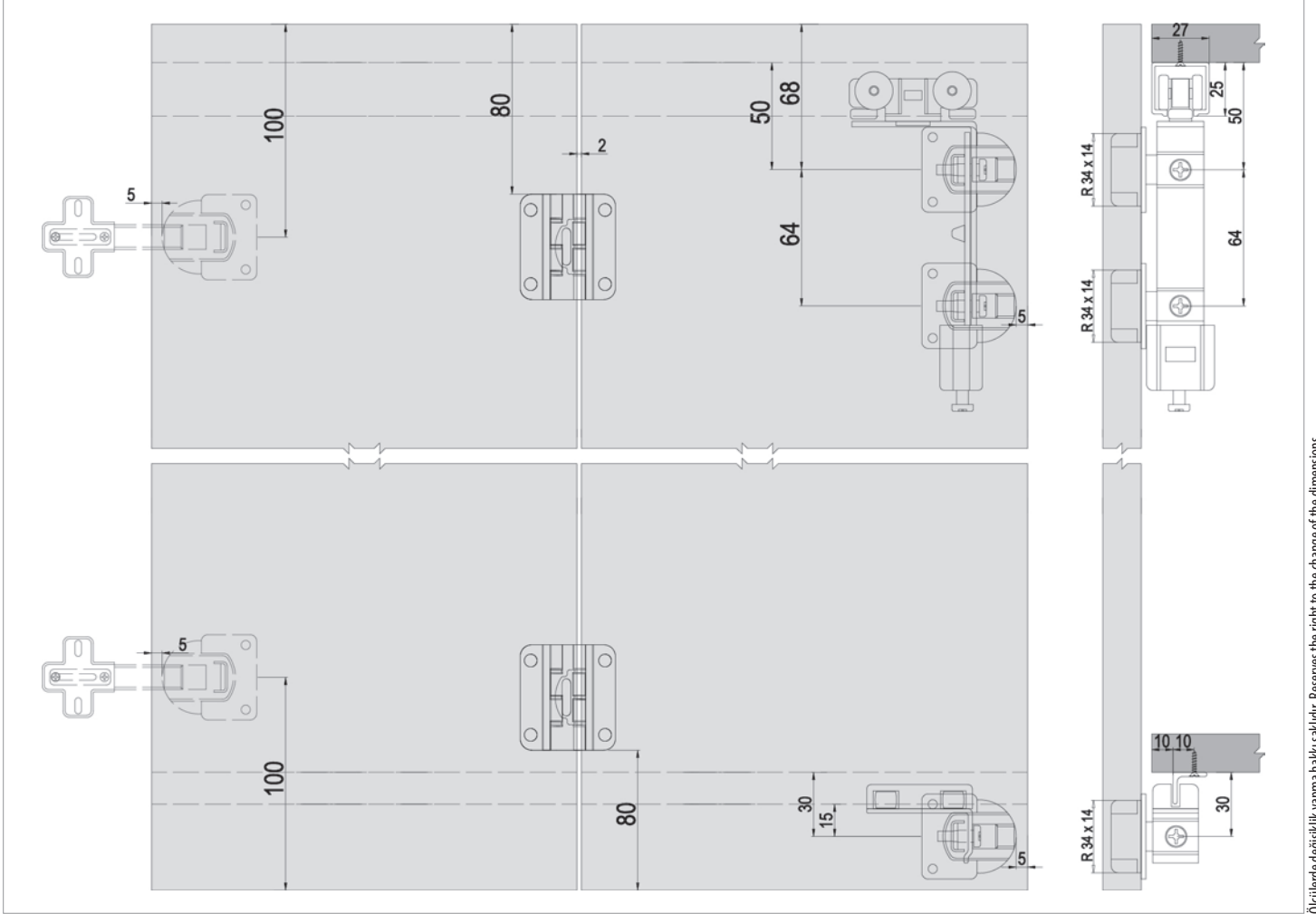

Ölçülerde değişiklik yapma hakkı saklıdır. Reserves the right to the change of the dimensions.

Kod / Code No	Açıklama / Description	Renk / Colour	Birim / Unit			Profil mt. / Profiles mt.	Bağ / Bnd.
105-7430-1300	40 Kg Katlanır Gardirop Sistem / 40 Kg Folding Wardrobe System	Galvaniz / Galvanized	1 Kapak / 1 Kit	24	576	-	-
105-7423-1300	Katlanır Kapak Sac Menteşe / Folding Door Sheet Iron Hinge	Galvaniz / Galvanized	1 Adet / 1 Pcs	250	-	-	-
105-7425-1300	Katlanır Kapak Zamak Menteşe / Folding Door Zinc Hinge	Galvaniz / Galvanized	1 Adet / 1 Pcs	240	-	-	-
105-7426-1700	Kulp Montaj Aparatı / Handle Assembly Kit	Gri / Grey	1 Adet / 1 Pcs	480	-	-	-
150-7450-1410	Alüminyum Üst Ray Profili / Aluminium Top Rail Profile	Eloksal / Mat Anodized	mt.	-	-	2,0	3,0
150-7460-1410	Alüminyum Alt Ray Profili / Aluminium Bottom Rail Profile	Eloksal / Mat Anodized	mt.	-	-	2,0	3,0

WingSlide 7440

105-7440

40 KG AYARLI KATLANIR SÜRME GARDIROP SİSTEMİ
40 KG ADJUSTABLE SLIDING SYSTEM FOR FOLDING DOORS



Bilgi / Information

- Maksimum kapak yüksekliği 240 cm önerilir.
- Maksimum 40 kg / 1 kapak
- Maksimum kapak eni 60 cm önerilir.
- 2 m'nin üzerindeki kapaklarda ilave menteşe kullanılmalıdır.
- Max. height of 240 cm
- Maximum 40 kg / 1 door
- Maximum width 60 cm
- Should be used additional hinges over 2 mt doors

Yavaşlatıcı Alternatifi / Soft Closer Alternative

- Katlanır kapak sistemlerinde yavaşlatıcı için, yavaşlatıcı menteşe tercih edebilirsiniz.
- For foldable door systems with soft closing, you can prefer soft closing hinge.



105-7440 1 Takım İçeriği / 1 Kit Includes

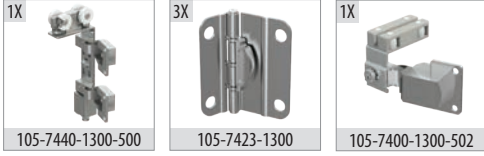

Ray Profilleri / Rail Profiles

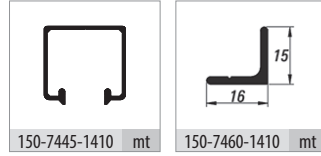

Opsiyonel / Optional



Teknik Detay / Technical Detail

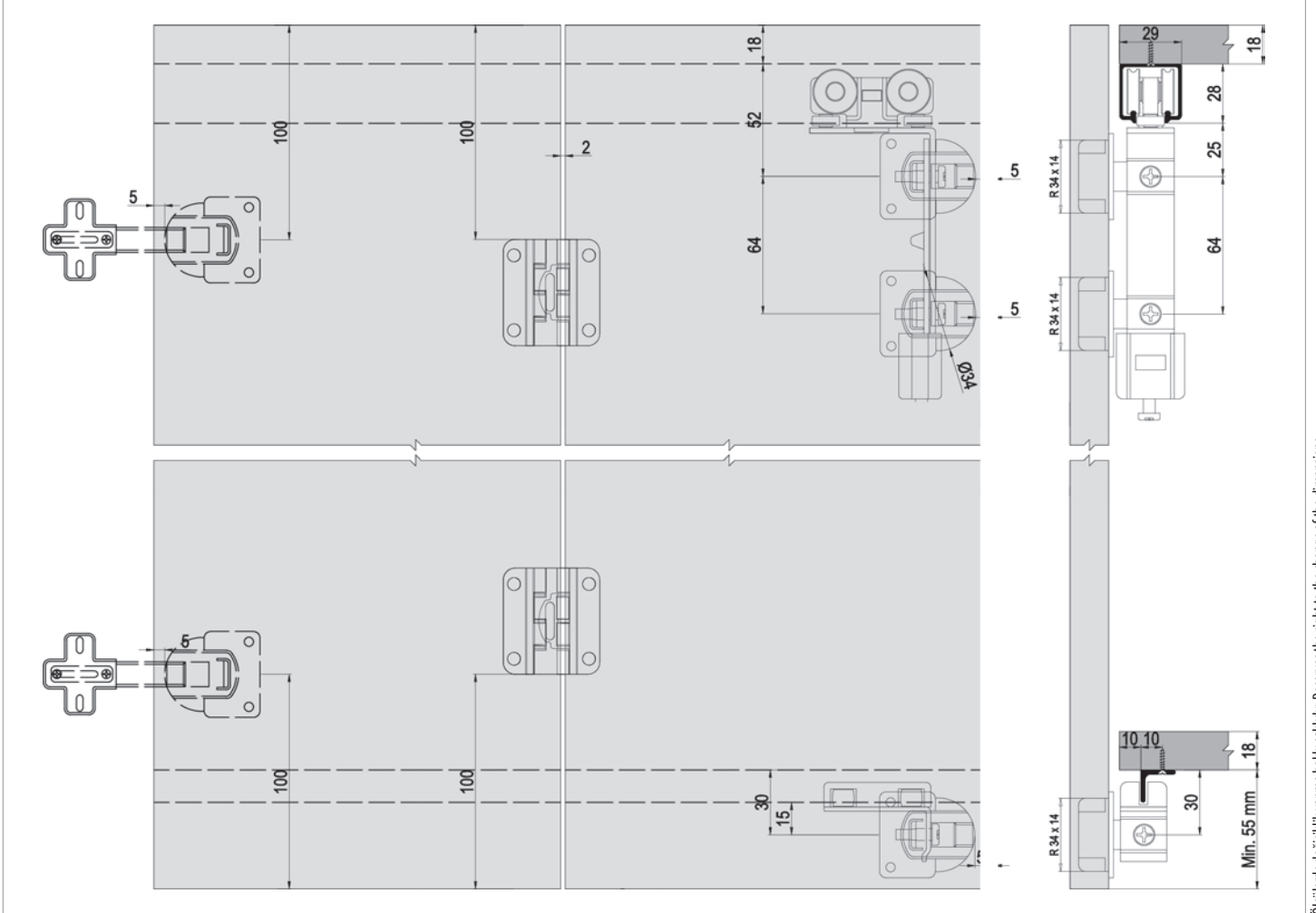

Ölçülerde değişiklik yapma hakkı saklıdır. Reserves the right to the change of the dimensions.

Kod / Code No	Açıklama / Description	Renk / Colour	Birim / Unit			Profil mt. / Profiles mt.	Bağ / Bnd.
105-7440-1300	40 Kg Katlanır Gardirop Sistem / 40 Kg Folding Wardrobe System	Galvaniz / Galvanized	1 Kapak / 1 Kit	24	576	-	-
105-7423-1300	Katlanır Kapak Sac Menteşe / Folding Door Sheet Iron Hinge	Galvaniz / Galvanized	1 Adet / 1 Pcs	250	-	-	-
105-7425-1300	Katlanır Kapak Zamak Menteşe / Folding Door Zinc Hinge	Galvaniz / Galvanized	1 Adet / 1 Pcs	240	-	-	-
105-7426-1700	Kulp Montaj Aparatı / Handle Assembly Kit	Gri / Grey	1 Adet / 1 Pcs	480	-	-	-
150-7445-1410	Alüminyum Üst Ray Profili / Aluminium Top Rail Profile	Eloksal / Mat Anodized	mt.	-	-	2,0	3,0
150-7460-1410	Alüminyum Alt Ray Profili / Aluminium Bottom Rail Profile	Eloksal / Mat Anodized	mt.	-	-	2,0	3,0



Bilgi / Information

- Maksimum kapak yüksekliği 240 cm önerilir.
- Maksimum 40 kg / 1 kapak
- Maksimum kapak eni 60 cm önerilir.
- 2 m'nin üzerindeki kapaklarda ilave menteşe kullanılmalıdır.
- Max. height of 240 cm
- Maximum 40 kg / 1 door
- Maximum width 60 cm
- Should be used additional hinges over 2 mt doors

Yavaşlatıcı Alternatifi / Soft Closer Alternative

- Katlanır kapak sistemlerinde yavaşlatıcı için, yavaşlatıcı menteşe tercih edebilirsiniz.
- For foldable door systems with soft closing, you can prefer soft closing hinge.



105-7441 1 Takım İçeriği / 1 Kit Includes

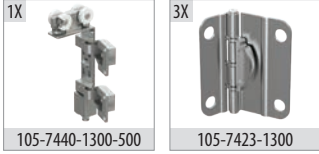

Ray Profilleri / Rail Profiles

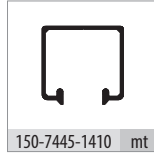

Opsiyonel / Optional



Teknik Detay / Technical Detail

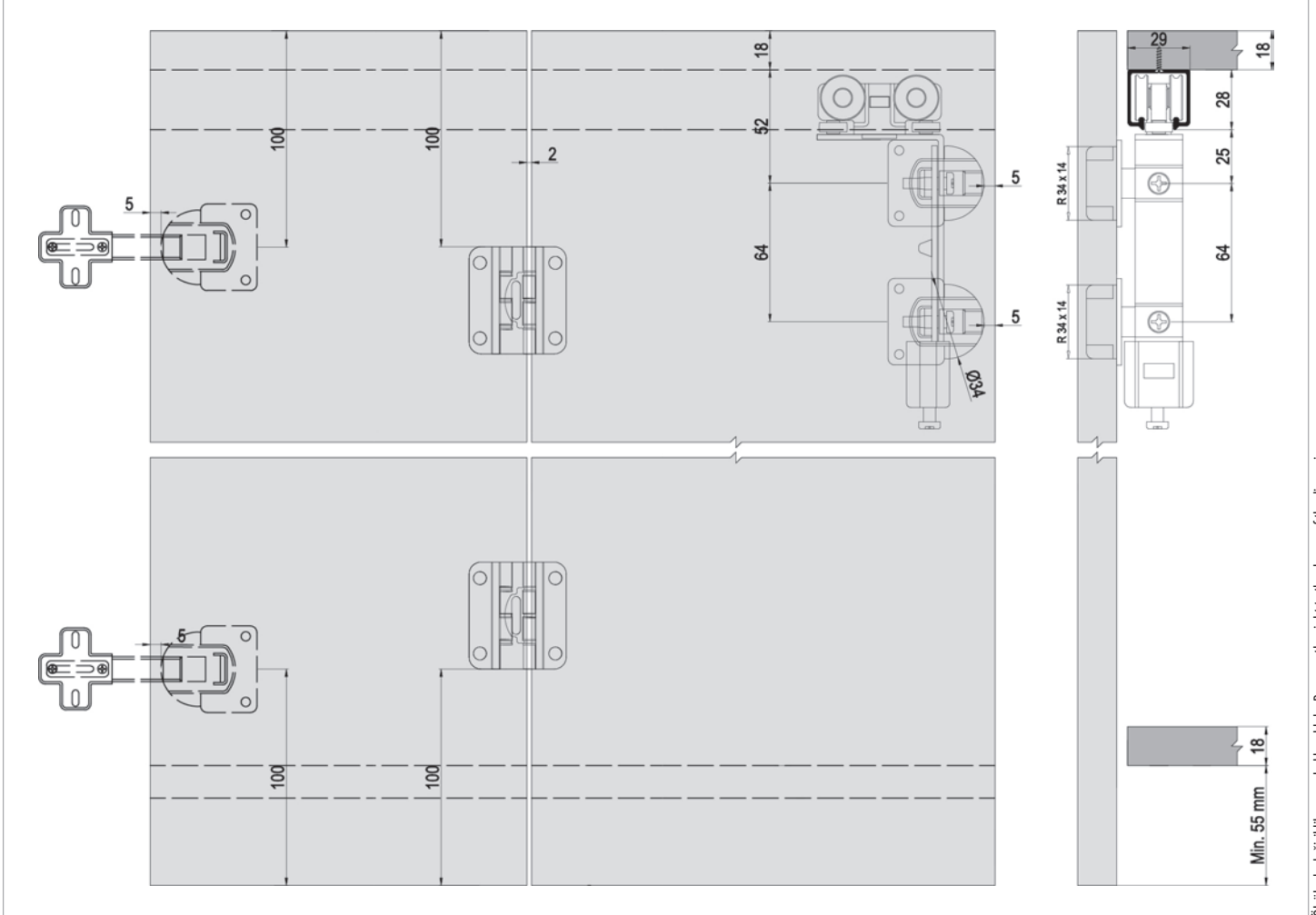



Ölçülerde değişiklik yapma hakkı saklıdır. Reserves the right to the change of the dimensions.

Kod / Code No	Açıklama / Description	Renk / Colour	Birim / Unit			Profil mt. / Profiles mt.	Bağ / Bnd.
105-7441-1300	40 Kg Katlanır Gardirop Sistem / 40 Kg Folding Wardrobe System	Galvaniz / Galvanized	1 Kapak / 1 Kit	24	576	- - -	-
105-7423-1300	Katlanır Kapak Sac Menteşe / Folding Door Sheet Iron Hinge	Galvaniz / Galvanized	1 Adet / 1 Pcs	250	-	- - -	-
105-7425-1300	Katlanır Kapak Zamak Menteşe / Folding Door Zinc Hinge	Galvaniz / Galvanized	1 Adet / 1 Pcs	240	-	- - -	-
105-7426-1700	Kulp Montaj Aparatı / Handle Assembly Kit	Gri / Grey	1 Adet / 1 Pcs	480	-	- - -	-
150-7445-1410	Alüminyum Üst Ray Profili / Aluminium Top Rail Profile	Eloksal / Mat Anodized	mt.	-	-	2,0 - 3,0	12 ad/pcs



WinaSlide 7440

<p>SINCE 1976</p>	 <p>Bearing Systems</p>	<p>EN 1527 100.000 CYCLES TEST</p> 	 <p>The Sliding System</p>
-----------------------	--	--	---



Group 108

Glassline[®]

Sürme Cam Kapak Serisi

Sliding Glass Door Series



Bu serideki tüm ürünleri incelemek için QR kodu okutabilirsiniz.

You can analyze the QR code to see all the products in these series.

	OEM Kod OEM Code	Ürün Kodu Product Code	Sistem Tipi System Type	Panel Tipi Panel Type	Fren Yönü Brake Direc.	Panel mm	Taşıma Kg Capacity Kg	Video	Üst Ray Upper Rail	Alt Ray Lower Rail	Kapı Adeti Number of Doors	Yavaşlatıcı Dahil Soft Closer Including
1	108-7020	Glassline 2				4 - 5	20	✓	150-7631	150-7633	2	✓
2	108-7500	Glassline 7500				4 - 6	25		150-7505	-	2	-
3	108-7600	Glassline 7600				4	15	✓	150-7615	-	2	-
4	108-7700	Glassline 7700				4 - 6	25	✓	150-7715	150-7710	2	-
5	108-7702	Glassline 7702				4 - 6	25	✓	150-7715	150-7710	2	-

- Verilen ölçüler bağlayıcı değildir. Önerilen kurulum ölçüleridir. Albatur ürün özelliklerinde haber vermeden değişiklik yapabilir.
- The given dimension are not binding. These are recommended asamble dimensions. Albatur can make alteration to product specification without notice.

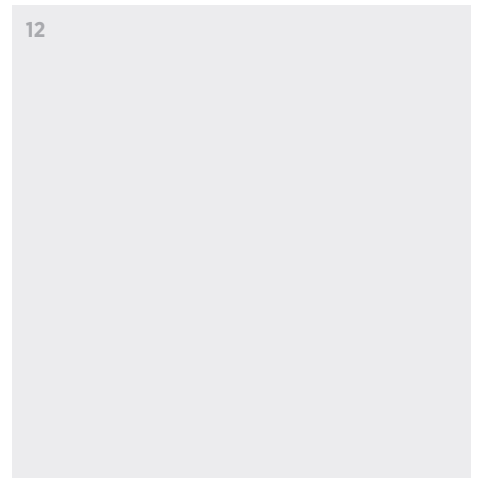
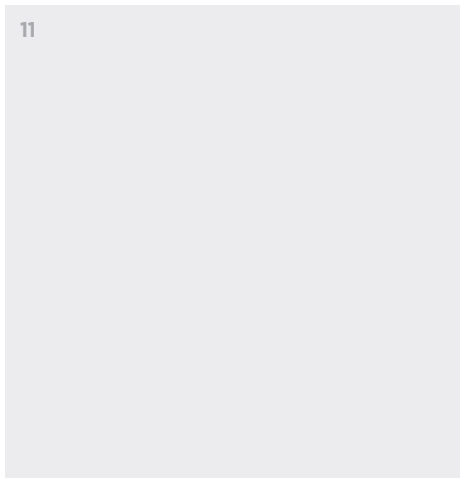
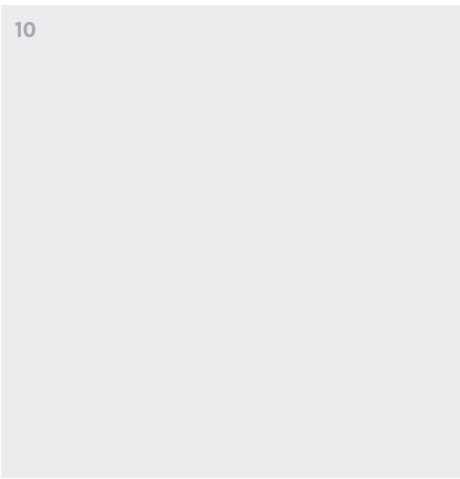
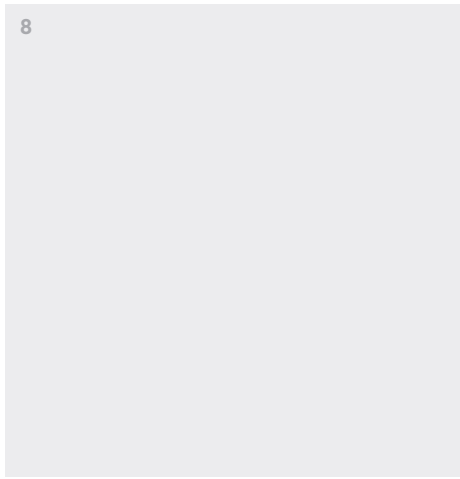
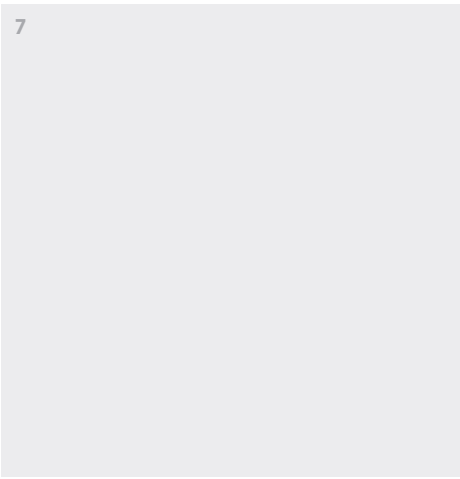
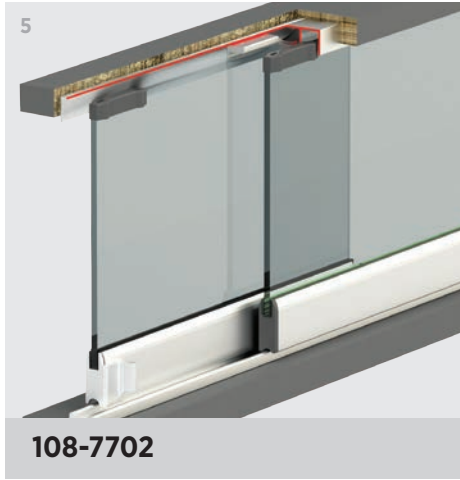
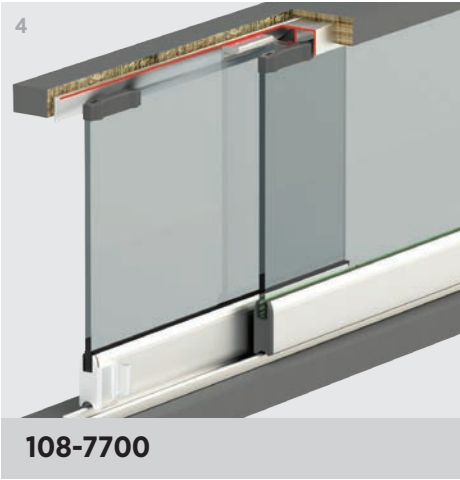
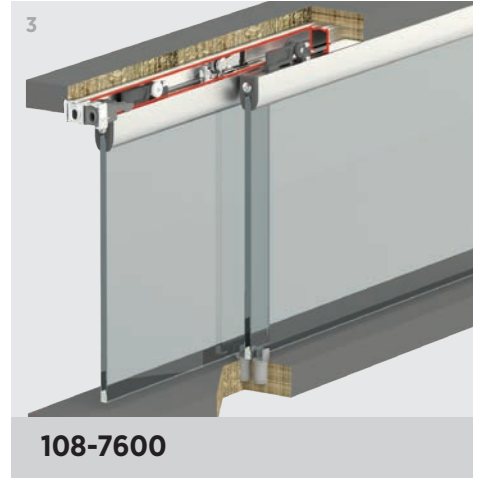
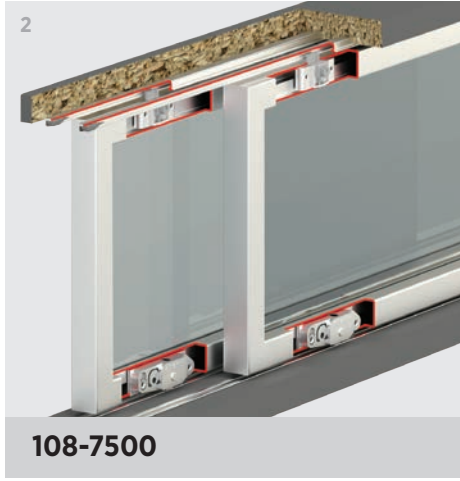
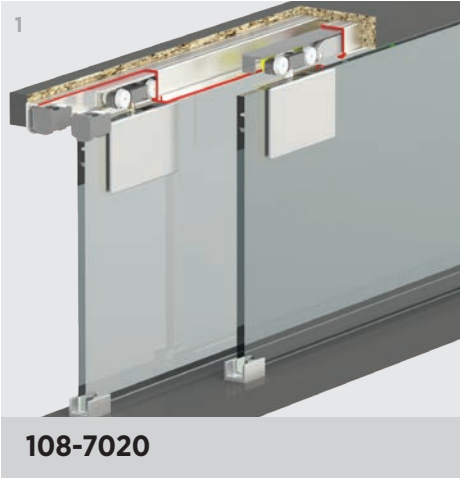

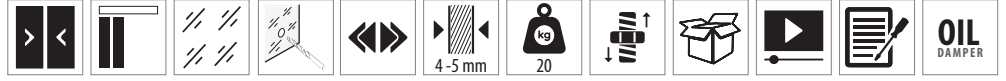
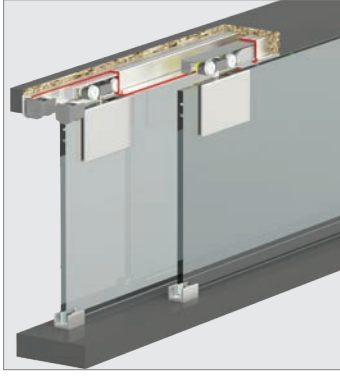

■ Yavaşlatıcı Alternatifi / Soft Closer Alternative

- Sistem üzerinde entegre yavaşlatıcı mevcuttur.
- There is an integrated soft close on the system.



■ 108-7020 1 Takım İçeriği / 1 Kit Includes

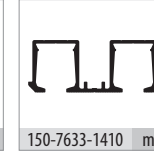
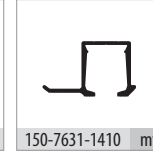
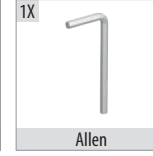
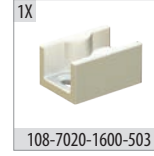
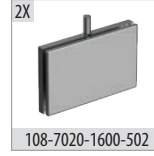
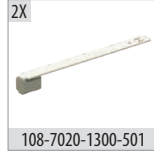
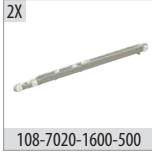

■ Ray Profilleri / Rail Profiles

■ Teknik Detay / Technical Detail

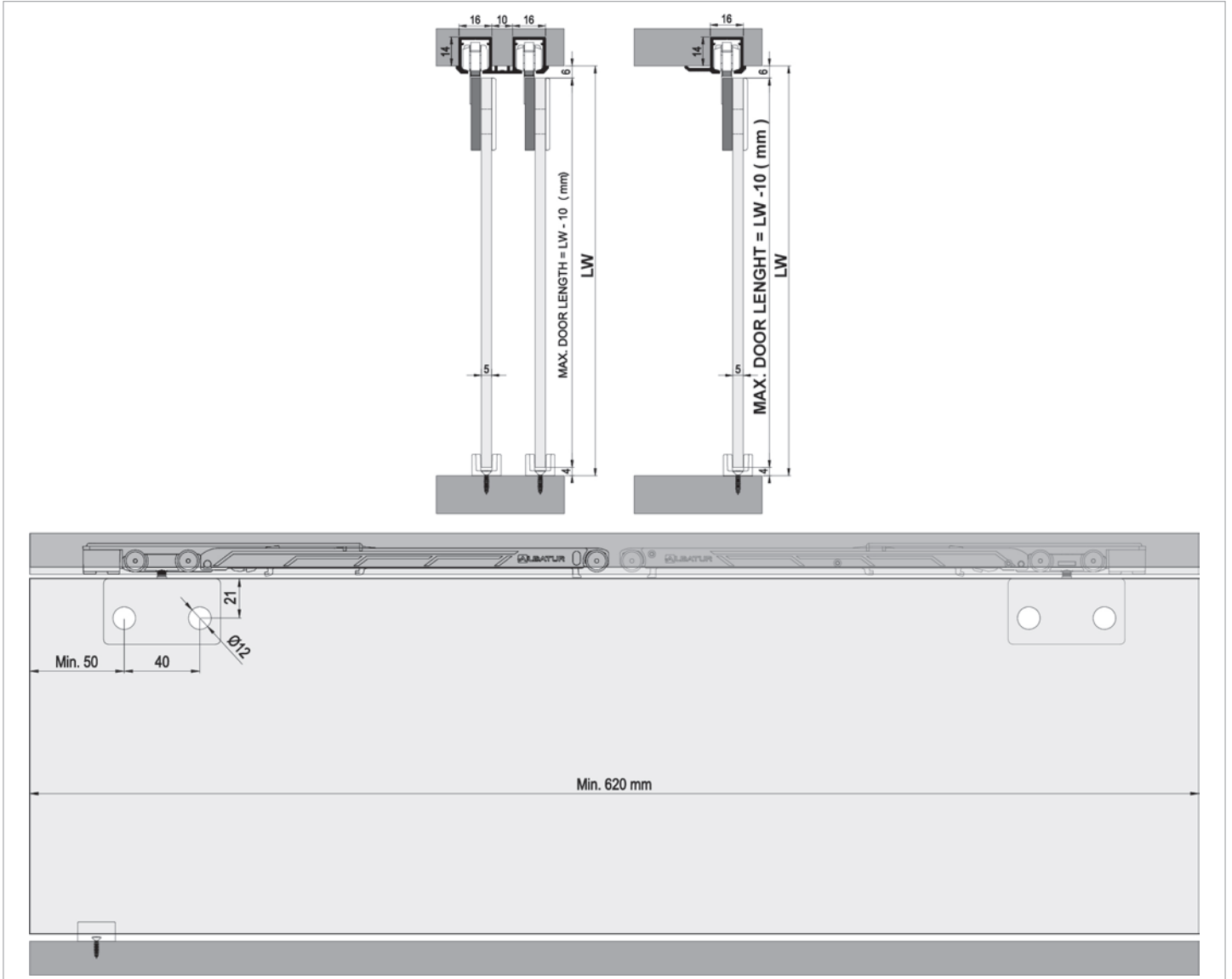

Özelliklerde değişiklik yapma hakkı saklıdır. Reserves the right to the change of the dimensions.

Kod / Code No	Açıklama / Description	Renk / Colour	Birim / Unit			Profil mt. / Profiles mt.	Bağ / Bnd.
108-7020-1600	Glassline 2 - 20 Kg Sürme Cam Kapak Sistemi / 20 Kg Sliding Glass Door System	Gri / Grey	1 Kapak / 1 Kit	12	360	-	-
150-7631-1410	Alüminyum Üst Ray Profili / Aluminium Top Rail Profile	Eloksal / Mat Anodized	mt.	-	-	-	3,0 10 ad/pcs
150-7633-1410	Alüminyum Üst Ray Profili / Aluminium Top Rail Profile	Eloksal / Mat Anodized	mt.	-	-	-	3,0 10 ad/pcs

Glassline 7500

108-7500

25 KG AYARLI ALÜMİNYUM ÇERÇEVE SÜRME SİSTEMİ
25 KG ADJUSTABLE ALUMINIUM FRAME SLIDING SYSTEM

Özel Üretim
Special Production

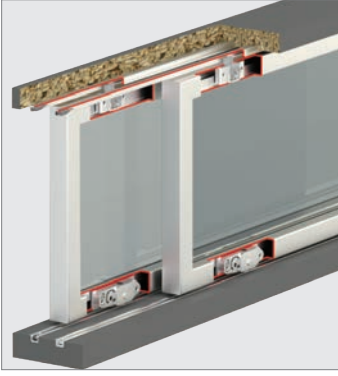

108-7500 1 Takım İçeriği / 1 Kit Includes

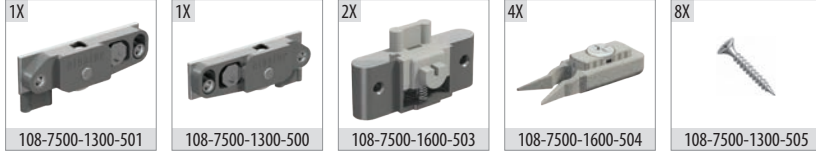

Ray Profilleri / Rail Profiles

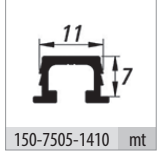

Örnek Uygulama Profilleri / Sample Application Profiles

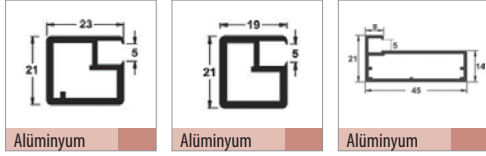

Uygulama / Application



Teknik Detay / Technical Detail

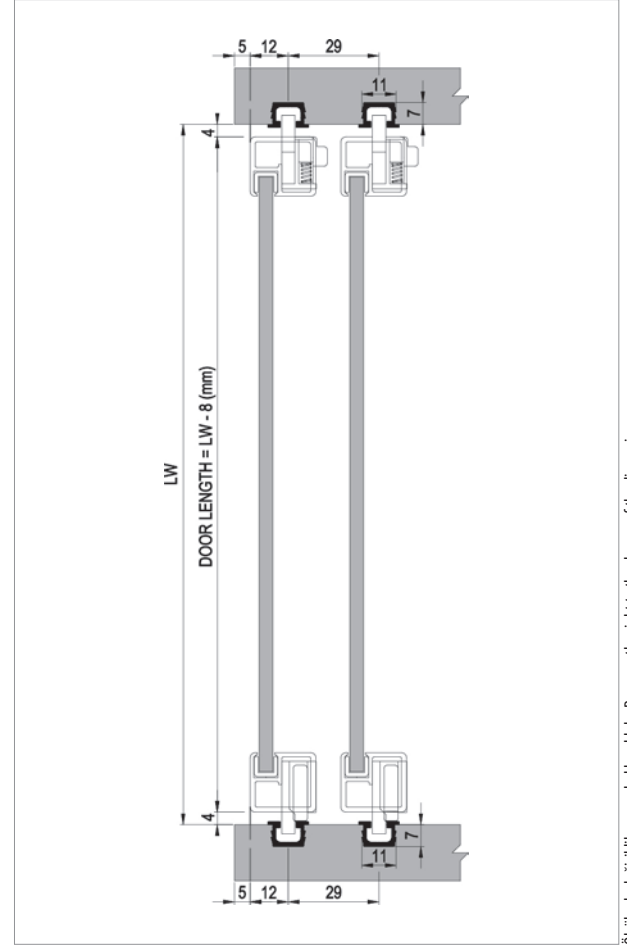

Ölçülerde değişiklik yapma hakkı saklıdır. Reserves the right to the change of the dimensions.

Kod / Code No	Açıklama / Description	Renk / Colour	Birim / Unit			Profil mt. / Profiles mt.	Bağ / Bnd.
108-7500-1300	Glassline 7500 - 25 Kg Sürme Cam Kapak Sistemi / 25 Kg Sliding Glass Door System	Galvaniz / Galvanized	1 Kapak / 1 Kit	20	2.400	- - -	-
150-7505-1410	Alüminyum Ray Profili / Aluminium Rail Profile	Eloksal / Mat Anodized	mt.	-	-	- - 3,0	30 ad/pcs

Glassline 7600

108-7600

15 KG AYARLI CAM SÜRME KAPAK SİSTEMİ
15 KG ADJUSTABLE GLASS DOOR SLIDING SYSTEM

Özel Üretim
Special Production

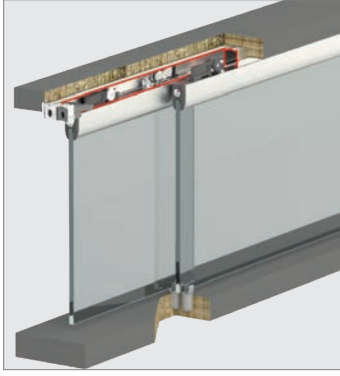

108-7600 1 Takım İçeriği / 1 Kit Includes



Ray Profilleri / Rail Profiles

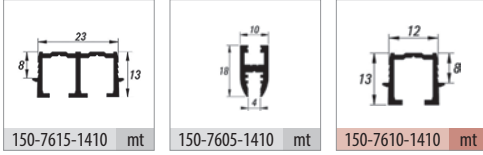

Teknik Detay / Technical Detail

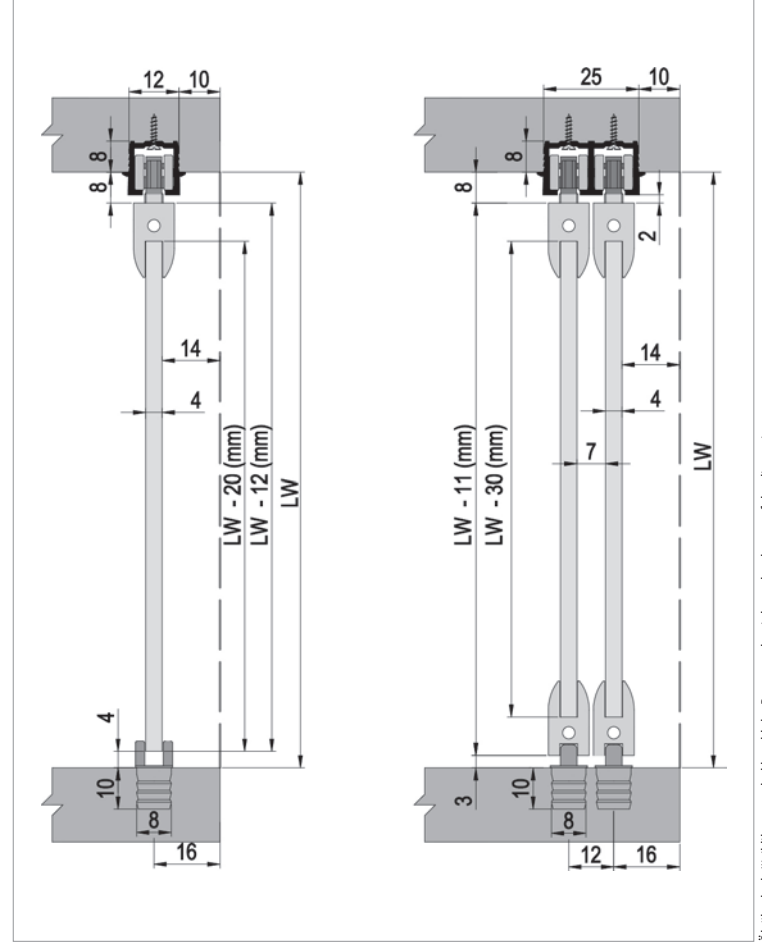

Ölçülerde değişiklik yapma hakkı saklıdır. Reserves the right to the change of the dimensions.

Kod / Code No	Açıklama / Description	Renk / Colour	Birim / Unit			Profil mt. / Profiles mt.	Bağ / Bnd.
108-7600-1600	Glassline 7600 - 15 Kg Sürme Cam Kapak Sistemi / 15 Kg Sliding Glass Door System	Gri / Grey	1 Kapak / 1 Kit	20	2.400	- - -	-
150-7615-1410	Alüminyum Üst Ray Profili / Aluminium Top Rail Profile	Eloksal / Mat Anodized	mt.	-	-	- - 3,0	10 ad/pcs
150-7610-1410	Alüminyum Üst Ray Profili / Aluminium Top Rail Profile	Eloksal / Mat Anodized	mt.	-	-	- - 3,0	10 ad/pcs
150-7605-1410	Alüminyum Cam Tutucu / Aluminium Frame	Eloksal / Mat Anodized	mt.	-	-	- - 3,0	10 ad/pcs

Glassline 7700

108-7700

25 KG CAM SÜRME CAM KAPAK SİSTEMİ
25 KG GLASS DOOR SLIDING SYSTEM

Özel Üretim
Special Production

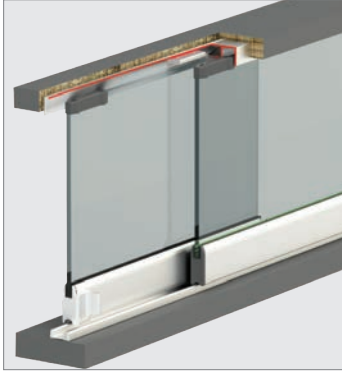

Bilgi / Information

- 4 mm uygulama için 145.1015.1640 fitil kullanılmalıdır.
- For 4 mm applications should be use 145.1015.1640 wick.



108-7700 1 Takım İçeriği - Kutuda 2 takım / 1 Kit Includes - 2 Set in a Box

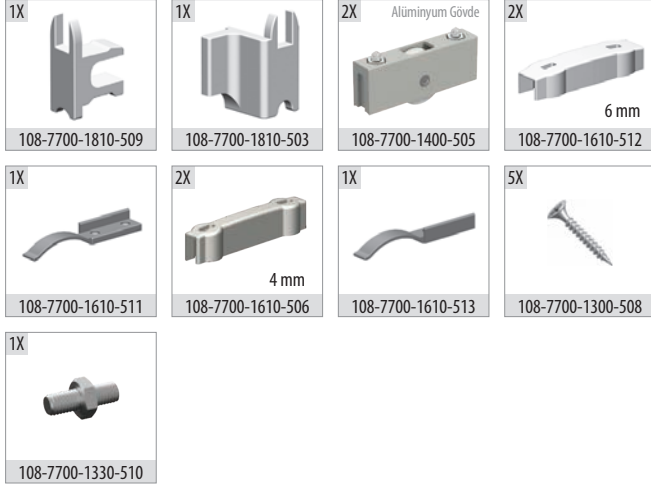

Ray Profilleri / Rail Profiles

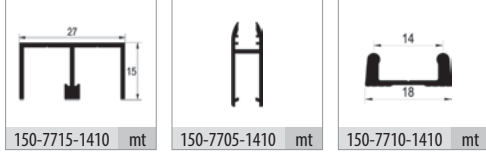

Opsiyonel Aksesuar / Optional Accessories



Teknik Detay / Technical Detail

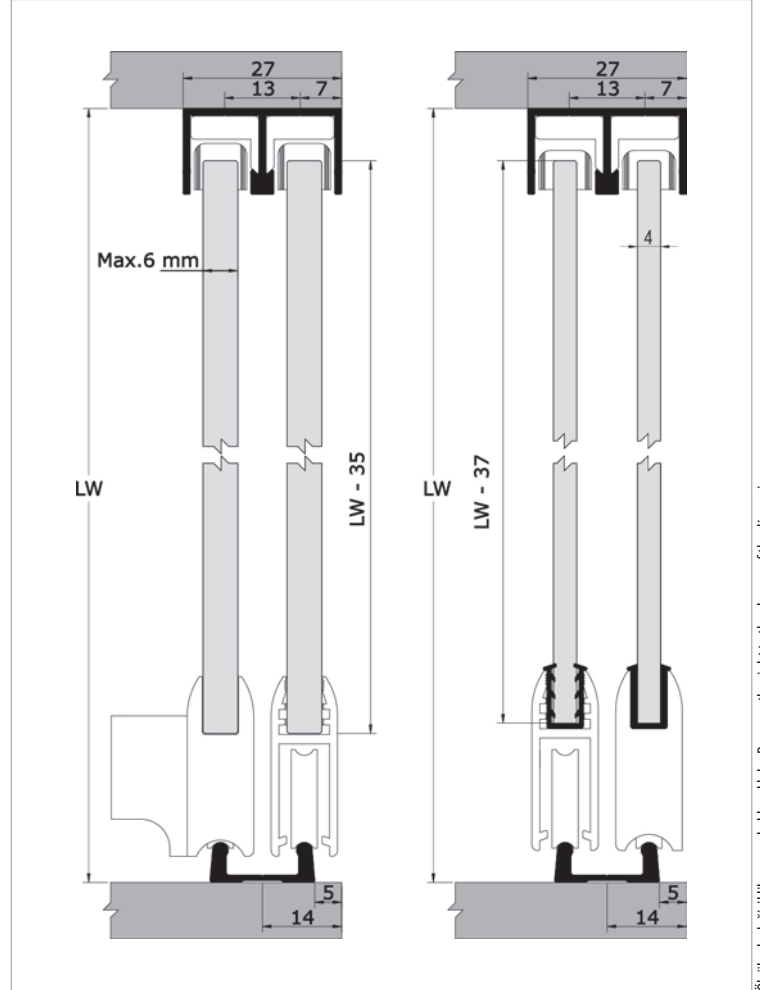

Ölçülerde değişiklik yapma hakkı saklıdır. Reserves the right to the change of the dimensions.

Kod / Code No	Açıklama / Description	Renk / Colour	Birim / Unit			Profil mt. / Profiles mt.	Bağ / Bnd.
108-7700-1400	Glassline 7700 - 25 Kg Sürme Cam Kapak Sistemi / 25 Kg Sliding Glass Door System	Gri / Grey	1 Kapak / 1 Kit	30	1.920	- - -	-
145-1015-1640	4 mm Cam Fitili / 4 mm Glass Wick	Şeffaf / Transparan	mt.	100	3.600	- - -	-
150-7715-1410	Alüminyum Üst Ray Profili / Aluminium Top Rail Profile	Eloksal / Mat Anodized	mt.	-	-	2,0 - 3,0	10 ad/pcs
150-7705-1410	Alüminyum Cam Tutucu / Aluminium Frame	Eloksal / Mat Anodized	mt.	-	-	2,0 - 3,0	10 ad/pcs
150-7710-1410	Alüminyum Alt Ray Profili / Aluminium Bottom Rail Profile	Eloksal / Mat Anodized	mt.	-	-	2,0 - 3,0	10 ad/pcs

Glassline 7702

108-7702

25 KG CAM SÜRME CAM KAPAK SİSTEMİ
25 KG GLASS DOOR SLIDING SYSTEM

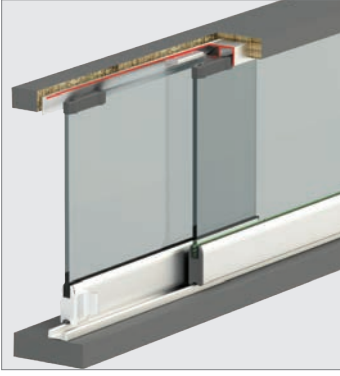

Bilgi / Information

- 4 mm uygulama için 145.1015.1640 fitil kullanılmalıdır.
- For 4 mm applications should be use 145.1015.1640 wick.



108-7702 1 Takım İçeriği - Kutuda 2 takım / 1 Kit Includes - 2 Set in a Box

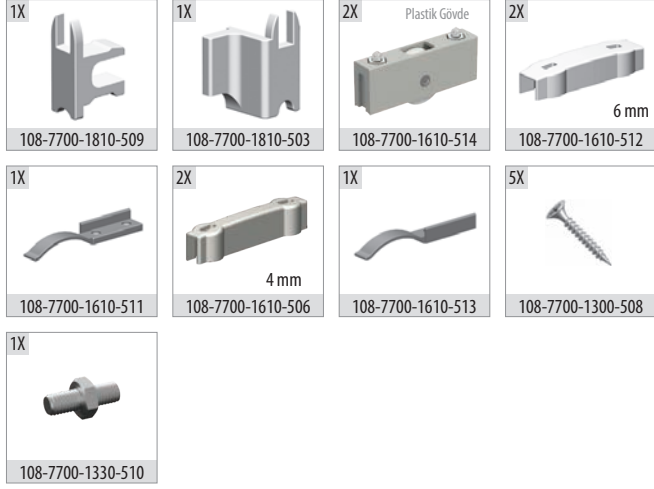

Ray Profilleri / Rail Profiles

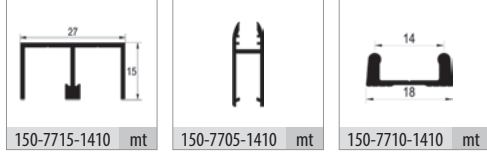

Opsiyonel Aksesuar / Optional Accessories



Teknik Detay / Technical Detail

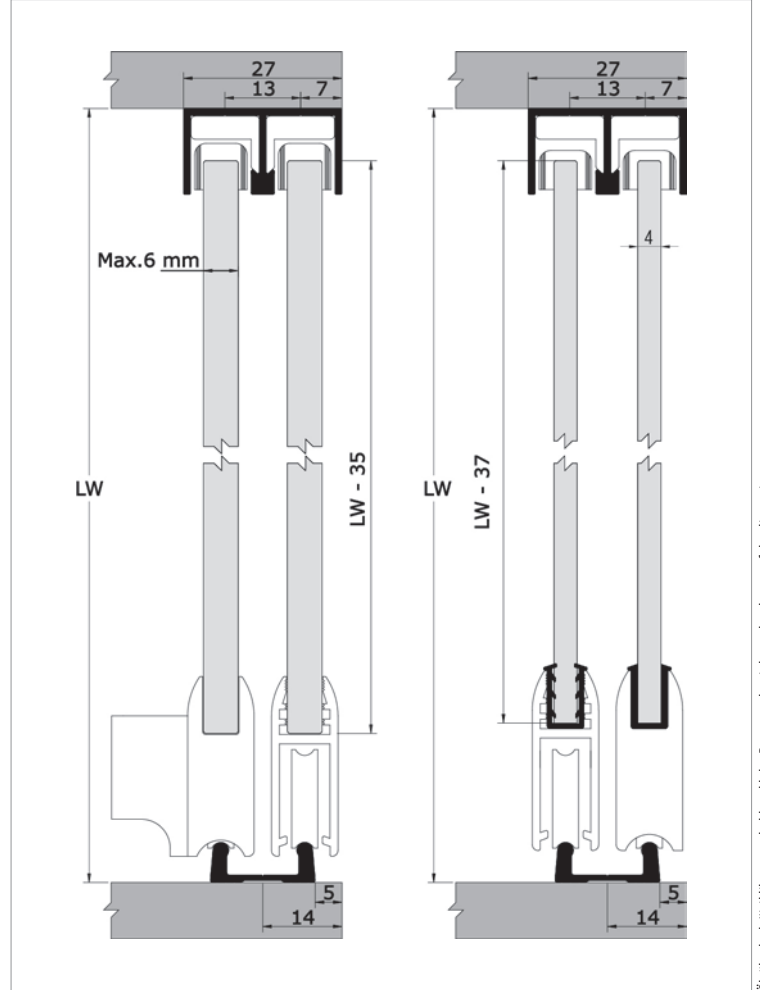

Ölçülerde değişiklik yapma hakkı saklıdır. Reserves the right to the change of the dimensions.

Kod / Code No	Açıklama / Description	Renk / Colour	Birim / Unit			Profil mt. / Profiles mt.	Bağ / Bnd.
108-7702-1600	Glassline 7702 - 25 Kg Sürme Cam Kapak Sistemi / 25 Kg Sliding Glass Door System	Gri / Grey	1 Kapak / 1 Kit	30	1.920	- - -	-
145-1015-1640	4 mm Cam Fitili / 4 mm Glass Wick	Şeffaf / Transparan	mt.	100	3.600	- - -	-
150-7715-1410	Alüminyum Üst Ray Profili / Aluminium Top Rail Profile	Eloksal / Mat Anodized	mt.	-	-	2,0 - 3,0	10 ad/pcs
150-7705-1410	Alüminyum Cam Tutucu / Aluminium Frame	Eloksal / Mat Anodized	mt.	-	-	2,0 - 3,0	10 ad/pcs
150-7710-1410	Alüminyum Alt Ray Profili / Aluminium Bottom Rail Profile	Eloksal / Mat Anodized	mt.	-	-	2,0 - 3,0	10 ad/pcs

Group 109

Rigel[®]

Sürme Ray Dolap Serisi
Sliding Rail Wardrobe Series

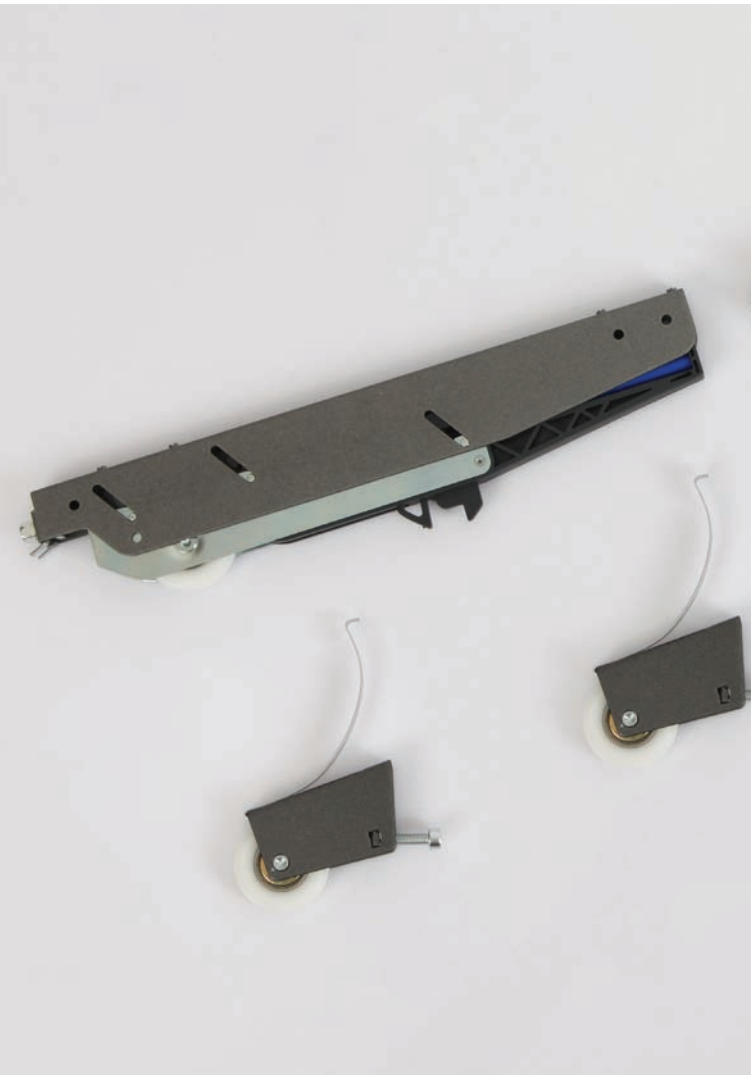



Bu serideki tüm ürünleri incelemek için
QR kodu okutabilirsiniz.

You can analyze the QR code to see all the
products in these series.



<p>SINCE 1976</p>	 <p>Bearing Systems</p>	<p>EN 1527 100.000 CYCLES TEST</p> 	<p>R</p> <p>The Sliding System</p>
-----------------------	--	--	---



	OEM Kod OEM Code	Ürün Kodu Product Code	Sistem Tipi System Type	Panel Tipi Panel Type	Fren Yönü Brake Direc.	Panel mm	Taşıma Kg Capacity Kg	Video	Üst Ray Upper Rail	Alt Ray Lower Rail	Kapak Adeti Number of Doors	Yavaşlatıcı Dahil Soft Closer Including
1	109-0251	Rigel 1				4 - 8	50	✓	150-2003	150-2003	2	✓
2	109-0252	Rigel 2				4 - 8	50	✓	150-2003	150-2003	2	✓
3	109-0253	Rigel 3				4 - 8	50	✓	150-2003	150-2003	2	✓
4	109-0254	Rigel 4				4 - 8	50		150-2003	150-2003	2	Optional
5	109-1801	Rigel 1801				4 - 8	60		150-1802	150-1813	2	Optional
6	109-1812	Rigel 1812				4 - 8	60		150-1802	150-1813	2	Optional

- Verilen ölçüler bağlayıcı değildir. Önerilen kurulum ölçüleridir. Albatür ürün özelliklerinde haber vermeden değişiklik yapabilir.
- The given dimension are not binding. These are recommended asamble dimensions. Albatür can make alteration to product specification without notice.

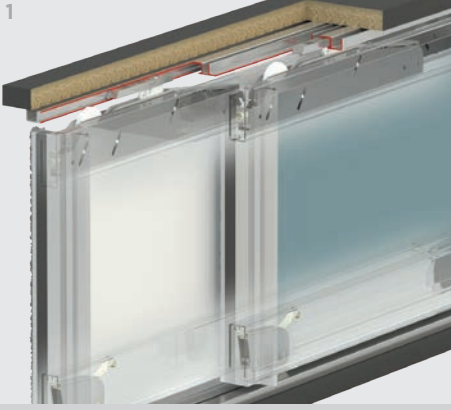

109-0251

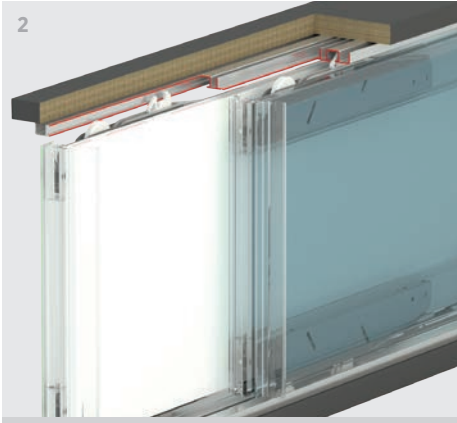

109-0252

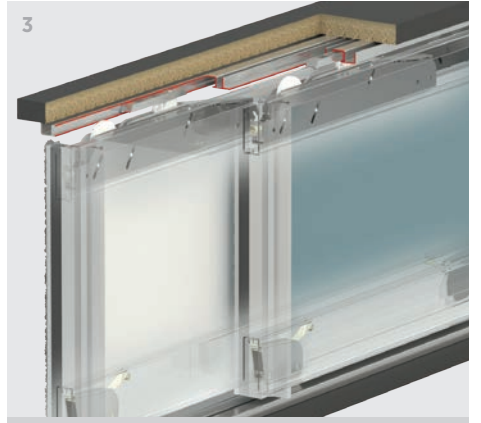

109-0253

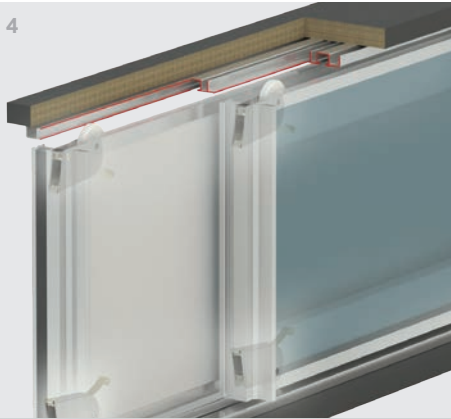

109-0254

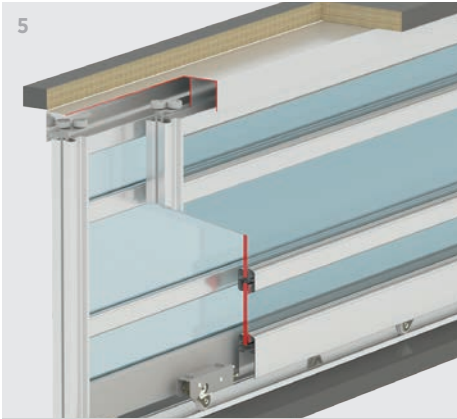

109-1801

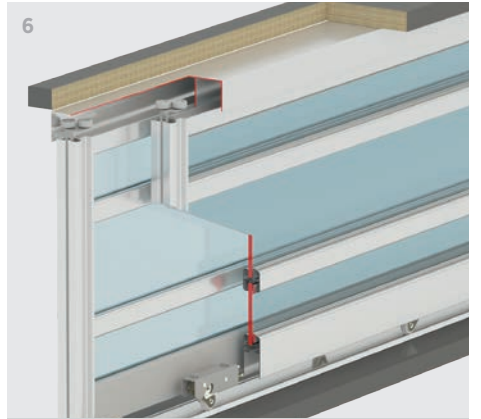

109-1812

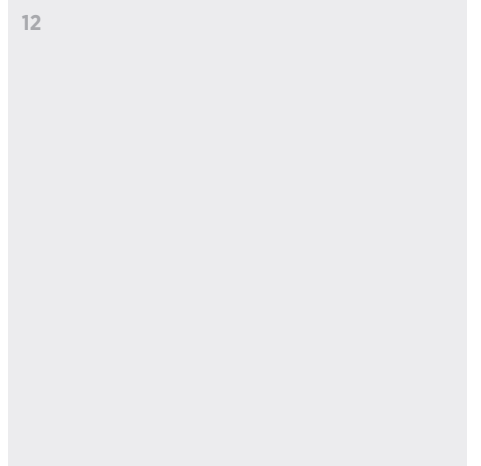
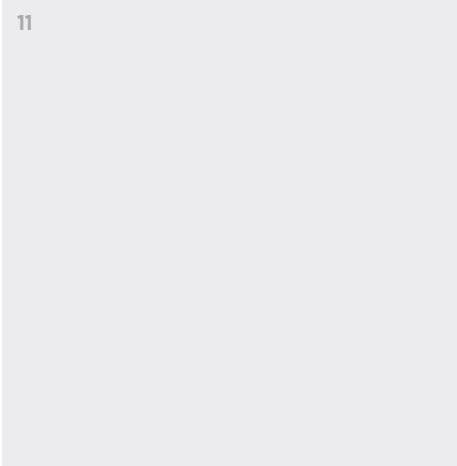
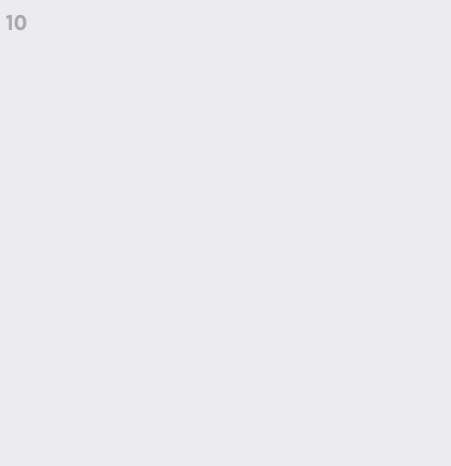
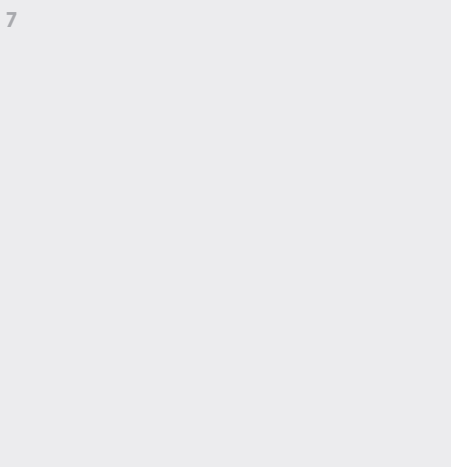

Rigel 1

109-0251

50 KG AYARLI SÜRME PANO SİSTEMİ

50 KG ADJUSTABLE SLIDING PANEL SYSTEM

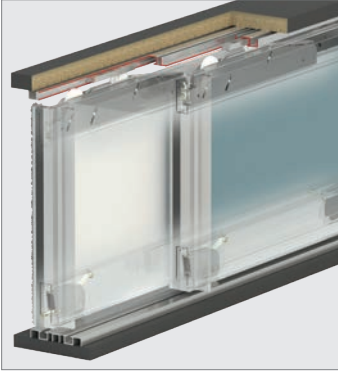

■ Yavaşlatıcı Alternatifi / Soft Closer Alternative

- Sistem üzerinde entegre yavaşlatıcı mevcuttur.
- There is an integrated soft close on the system.



■ 109-0251 1 Takım İçeriği / 1 Kit Includes

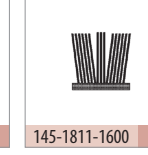
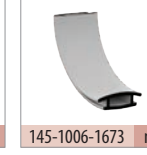
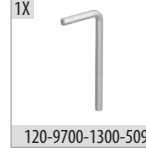
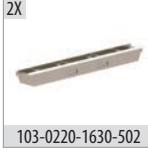
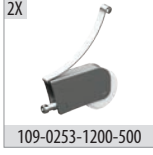
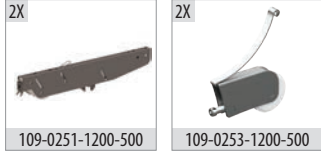

■ Alüminyum Fitilleri / Aluminium Wicks

■ Ray Profilleri / Rail Profiles

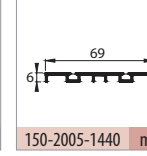
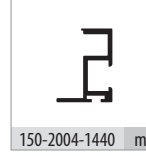
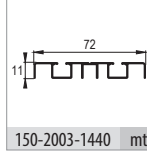
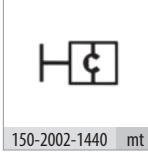
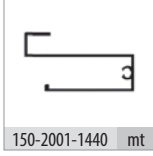
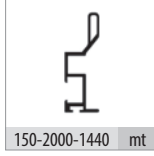

■ Teknik Detay / Technical Detail

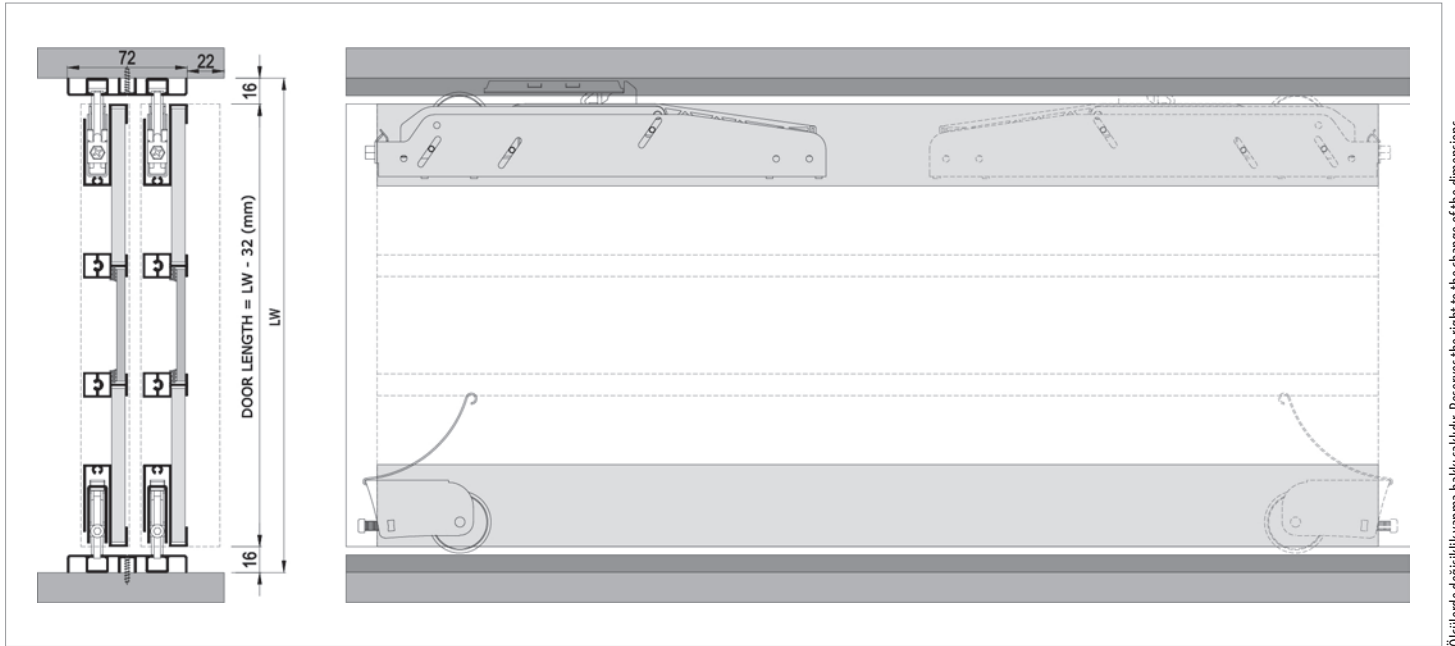

Ölçülerde değişiklik yapma hakkı saklıdır. Reserves the right to the change of the dimensions.

Kod / Code No	Açıklama / Description	Renk / Colour	Birim / Unit			Profil mt. / Profiles mt.	Bağ / Bnd.
109-0251-1200	RIGEL 1 - 50 Kg Sürme Pano Sistemi / 50 Kg Sliding Panel System	Silver	1 Kapak / 1 Kit	24	720	- - -	-
145-1810-1640	Cam Fitolu / Glass Wick	Gri / Grey	mt.	100	3.600	- - -	-
145-1006-1673	Kapama Fitolu / Closing Wick	Gri / Grey	mt.	100	3.600	- - -	-
145-1811-1600	Kıl Fitolu / Ec-Wf Hair Wick	Gri / Grey	mt.	300	7.200	- - -	-
150-2003-1440	Alüminyum Ray Profili / Aluminium Rail Profile	Bronz Parlak / Bronze Bright	mt.	-	-	- - 3,0	10 ad/pcs
150-2000-1440	Alüminyum Kulp Profili / Aluminium Handle Profile	Bronz Parlak / Bronze Bright	mt.	-	-	- - 3,0	6 ad/pcs
150-2001-1440	Alüminyum Alt-Üst Kayıt Profili / Aluminium Bottom-Top Profile	Bronz Parlak / Bronze Bright	mt.	-	-	- - 3,0	6 ad/pcs
150-2002-1440	Alüminyum Orta Kayıt Profili / Aluminium Horizontal Central Profile	Bronz Parlak / Bronze Bright	mt.	-	-	- - 3,0	10 ad/pcs
150-2004-1440	Alüminyum Kulp Profili / Aluminium Handle Profile	Bronz Parlak / Bronze Bright	mt.	-	-	- - 3,0	6 ad/pcs

Rigel 2

109-0252

50 KG AYARLI SÜRME PANO SİSTEMİ
50 KG ADJUSTABLE SLIDING PANEL SYSTEM

Özel Üretim
Special Production

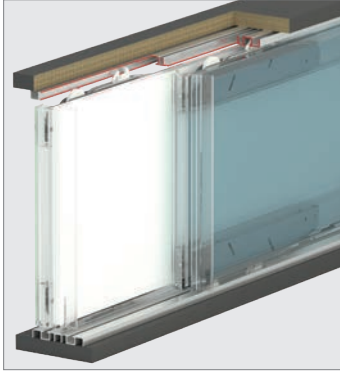

■ Yavaşlatıcı Alternatifi / Soft Closer Alternative

- Sistem üzerinde entegre yavaşlatıcı mevcuttur.
- There is an integrated soft close on the system.



■ 109-0252 1 Takım İçeriği / 1 Kit Includes

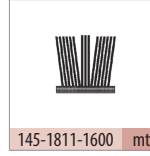
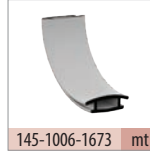
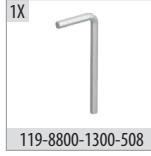

■ Alüminyum Fitilleri / Aluminium Wicks

■ Ray Profilleri / Rail Profiles

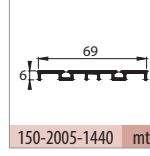
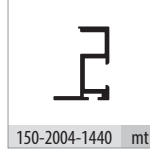
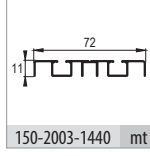
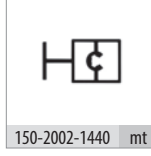
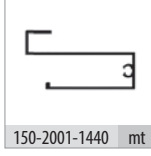
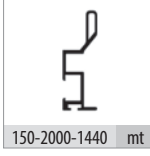

■ Teknik Detay / Technical Detail

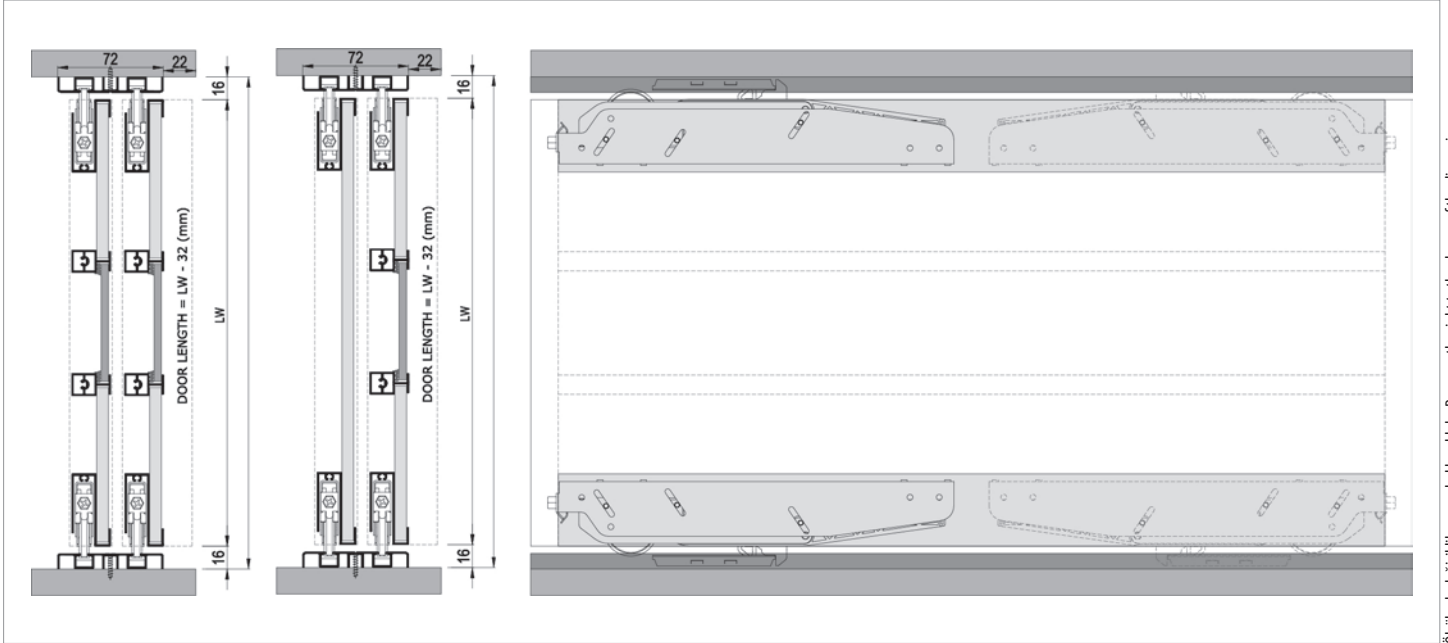

Ölçülerde değişiklik yapma hakkı saklıdır. Reserves the right to the change of the dimensions.

Kod / Code No	Açıklama / Description	Renk / Colour	Birim / Unit			Profil mt. / Profiles mt.	Bağ / Bnd.
109-0252-1200	RIGEL 2 - 50 Kg Sürme Pano Sistemi / 50 Kg Sliding Panel System	Silver	1 Kapak / 1 Kit	12	360	- - -	-
145-1810-1640	Cam Fitolu / Glass Wick	Gri / Grey	mt.	100	3.600	- - -	-
145-1006-1673	Kapama Fitolu / Closing Wick	Gri / Grey	mt.	100	3.600	- - -	-
145-1811-1600	Kıl Fitolu / Ec-Wf Hair Wick	Gri / Grey	mt.	300	7.200	- - -	-
150-2003-1440	Alüminyum Ray Profili / Aluminium Rail Profile	Bronz Parlak / Bronze Bright	mt.	-	-	- - 3,0	10 ad/pcs
150-2000-1440	Alüminyum Kulp Profili / Aluminium Handle Profile	Bronz Parlak / Bronze Bright	mt.	-	-	- - 3,0	6 ad/pcs
150-2001-1440	Alüminyum Alt-Üst Kayıt Profili / Aluminium Bottom-Top Profile	Bronz Parlak / Bronze Bright	mt.	-	-	- - 3,0	6 ad/pcs
150-2002-1440	Alüminyum Orta Kayıt Profili / Aluminium Horizontal Central Profile	Bronz Parlak / Bronze Bright	mt.	-	-	- - 3,0	10 ad/pcs
150-2004-1440	Alüminyum Kulp Profili / Aluminium Handle Profile	Bronz Parlak / Bronze Bright	mt.	-	-	- - 3,0	6 ad/pcs

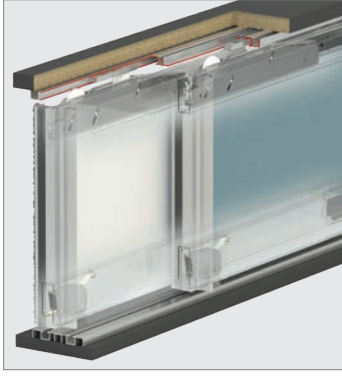

■ Yavaşlatıcı Alternatifi / Soft Closer Alternative

- Sistem üzerinde entegre yavaşlatıcı mevcuttur.
- There is an integrated soft close on the system.



■ 109-0253 1 Adet İçeriği / 1 Pcs. Includes

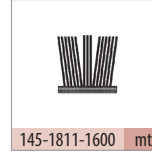
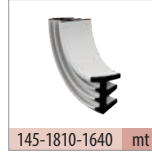

■ Ray Profilleri / Rail Profiles

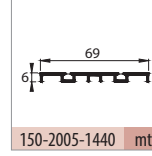
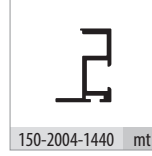
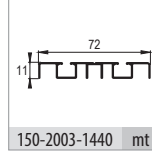
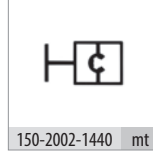
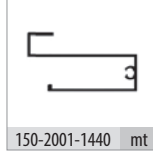
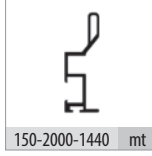

■ Teknik Detay / Technical Detail

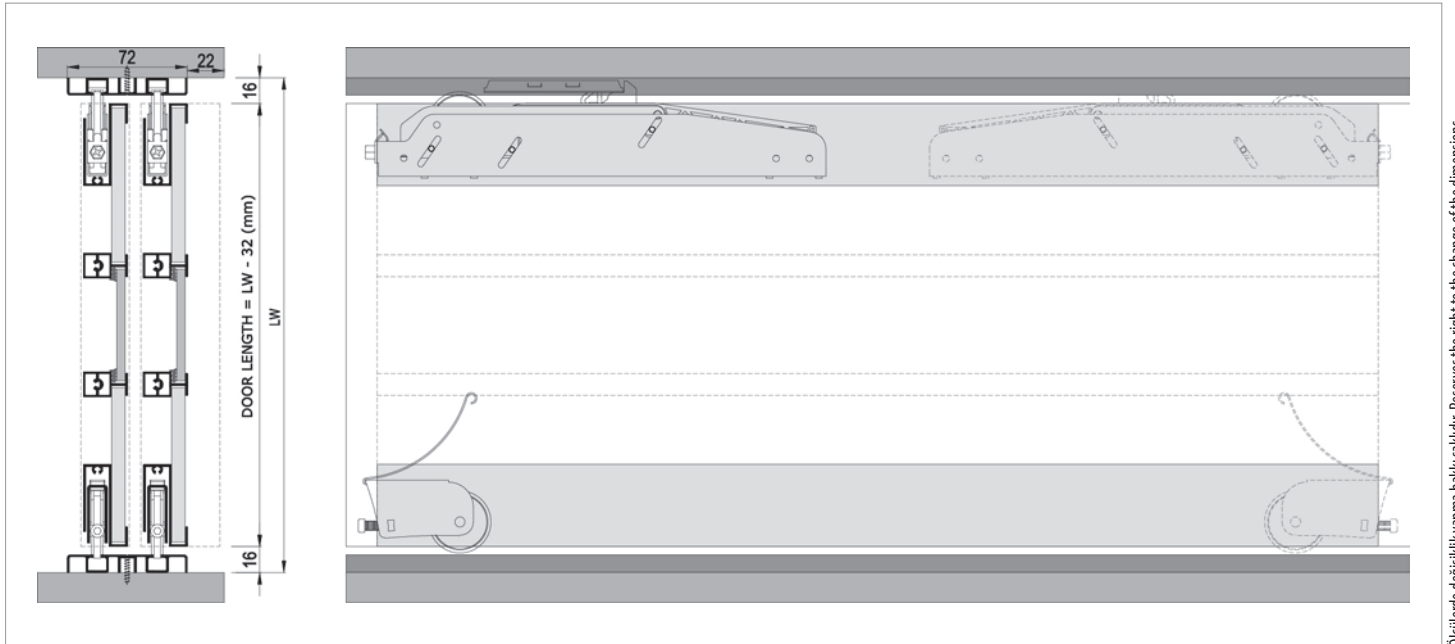

Ölçülerde değişiklik yapma hakkı saklıdır. Reserves the right to the change of the dimensions.

Kod / Code No	Açıklama / Description	Renk / Colour	Birim / Unit			Profil mt. / Profiles mt.	Bağ / Bnd.
109-0253-1200	RIGEL 3 - 50 Kg Sürme Pano Sistemi / 50 Kg Sliding Panel System	Silver	1 Adet / 1 Pcs	40	1.280	- - -	-
145-1810-1640	Kapama Fitolu / Closing Wick	Gri / Grey	mt.	100	3.600	- - -	-
145-1006-1673	Kapama Fitolu / Closing Wick	Gri / Grey	mt.	100	3.600	- - -	-
145-1811-1600	Kıl Fitolu / Ec-Wf Hair Wick	Gri / Grey	mt.	300	7.200	- - -	-
150-2003-1440	Alüminyum Ray Profili / Aluminium Rail Profile	Bronz Parlak / Bronze Bright	mt.	-	-	- - 3,0	10 ad/pcs
150-2000-1440	Alüminyum Kulp Profili / Aluminium Handle Profile	Bronz Parlak / Bronze Bright	mt.	-	-	- - 3,0	6 ad/pcs
150-2001-1440	Alüminyum Alt-Üst Kayıt Profili / Aluminium Bottom-Top Profile	Bronz Parlak / Bronze Bright	mt.	-	-	- - 3,0	6 ad/pcs
150-2002-1440	Alüminyum Orta Kayıt Profili / Aluminium Horizontal Central Profile	Bronz Parlak / Bronze Bright	mt.	-	-	- - 3,0	10 ad/pcs
150-2004-1440	Alüminyum Kulp Profili / Aluminium Handle Profile	Bronz Parlak / Bronze Bright	mt.	-	-	- - 3,0	6 ad/pcs

Rigel 4

109-0254

50 KG AYARLI SÜRME PANO SİSTEMİ
50 KG ADJUSTABLE SLIDING PANEL SYSTEM

Özel Üretim
Special Production

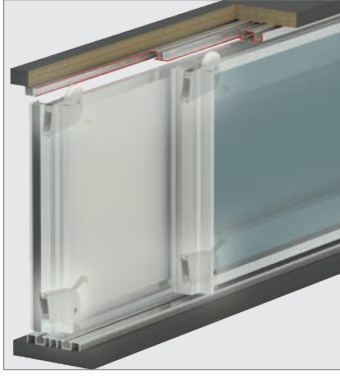

109-0254 1 Takım İçeriği / 1 Kit Includes



Alüminyum Fitilleri / Aluminium Wicks

Ray Profilleri / Rail Profiles

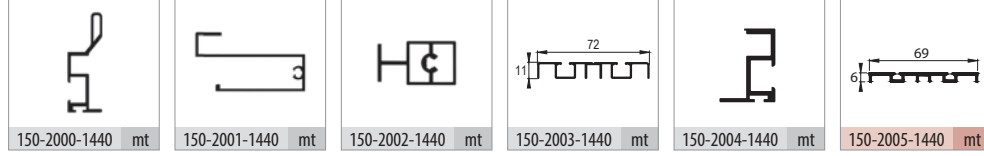

Teknik Detay / Technical Detail

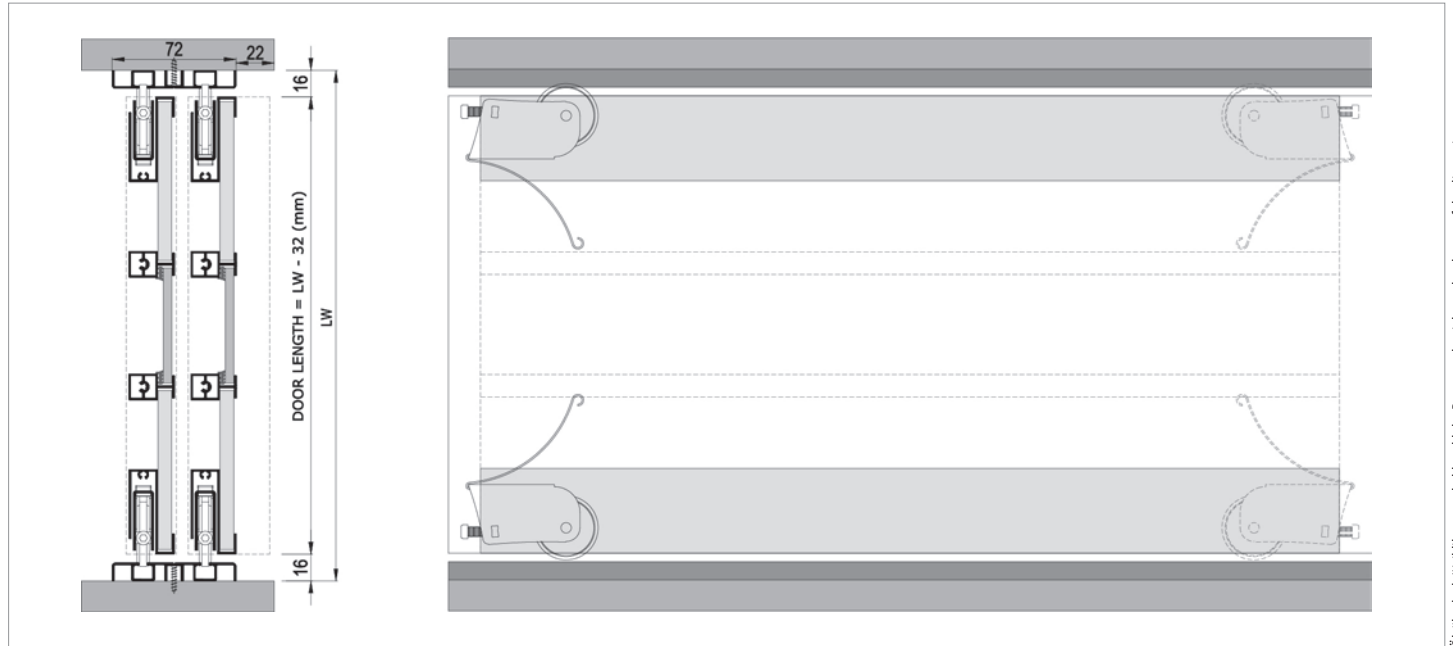

Ölçülerde değişiklik yapma hakkı saklıdır. Reserves the right to the change of the dimensions.

Kod / Code No	Açıklama / Description	Renk / Colour	Birim / Unit			Profil mt. / Profiles mt.	Bağ / Bnd.
109-0254-1200	RIGEL 4 - 50 Kg Sürme Pano Sistemi / 50 Kg Sliding Panel System	Silver	1 Takım / 1 Kit	32	1.024	- - -	-
145-1810-1640	Kapama Fitolu / Closing Wick	Gri / Grey	mt.	100	3.600	- - -	-
145-1006-1673	Kapama Fitolu / Closing Wick	Gri / Grey	mt.	100	3.600	- - -	-
145-1811-1600	Kıl Fitolu / Ec-Wf Hair Wick	Gri / Grey	mt.	300	7.200	- - -	-
150-2003-1440	Alüminyum Ray Profili / Aluminium Rail Profile	Bronz Parlak / Bronze Bright	mt.	-	-	- - 3,0	10 ad/pcs
150-2000-1440	Alüminyum Kulp Profili / Aluminium Handle Profile	Bronz Parlak / Bronze Bright	mt.	-	-	- - 3,0	6 ad/pcs
150-2001-1440	Alüminyum Alt-Üst Kayıt Profili / Aluminium Bottom-Top Profile	Bronz Parlak / Bronze Bright	mt.	-	-	- - 3,0	6 ad/pcs
150-2002-1440	Alüminyum Orta Kayıt Profili / Aluminium Horizontal Central Profile	Bronz Parlak / Bronze Bright	mt.	-	-	- - 3,0	10 ad/pcs
150-2004-1440	Alüminyum Kulp Profili / Aluminium Handle Profile	Bronz Parlak / Bronze Bright	mt.	-	-	- - 3,0	6 ad/pcs

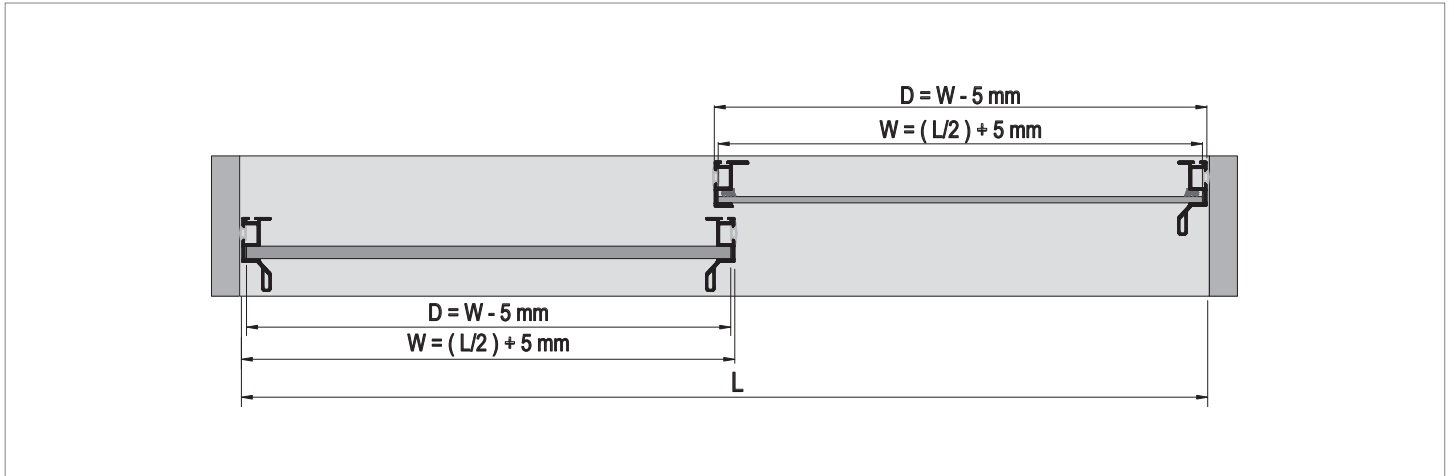
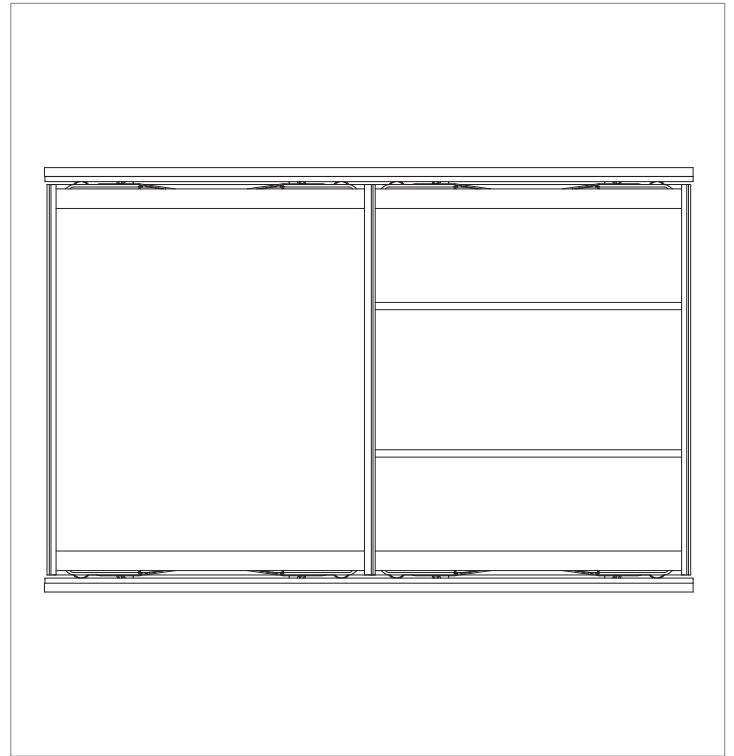
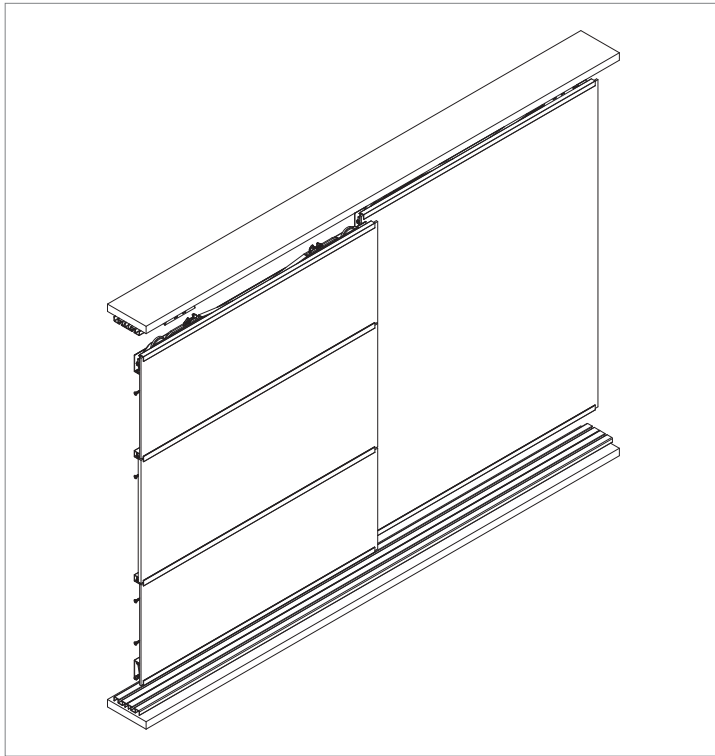
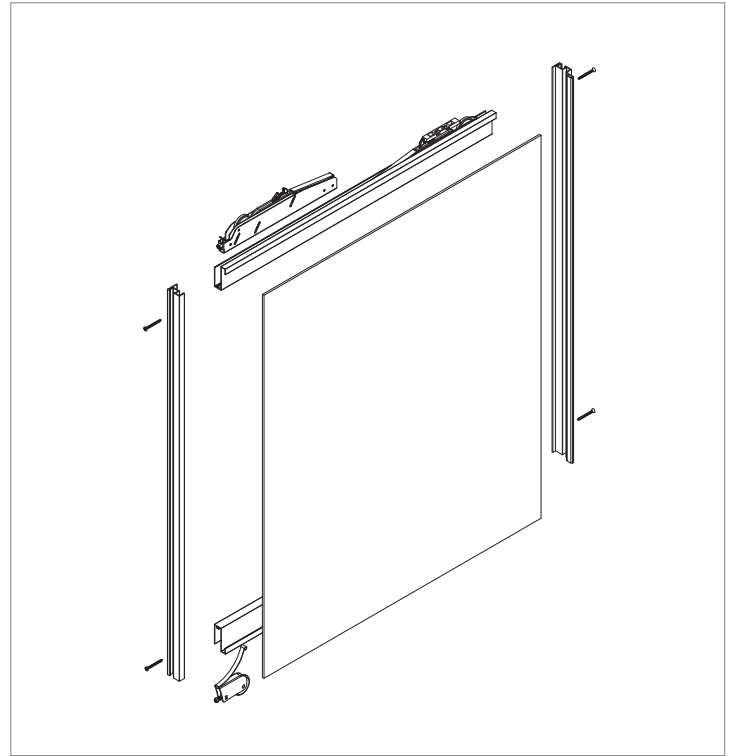
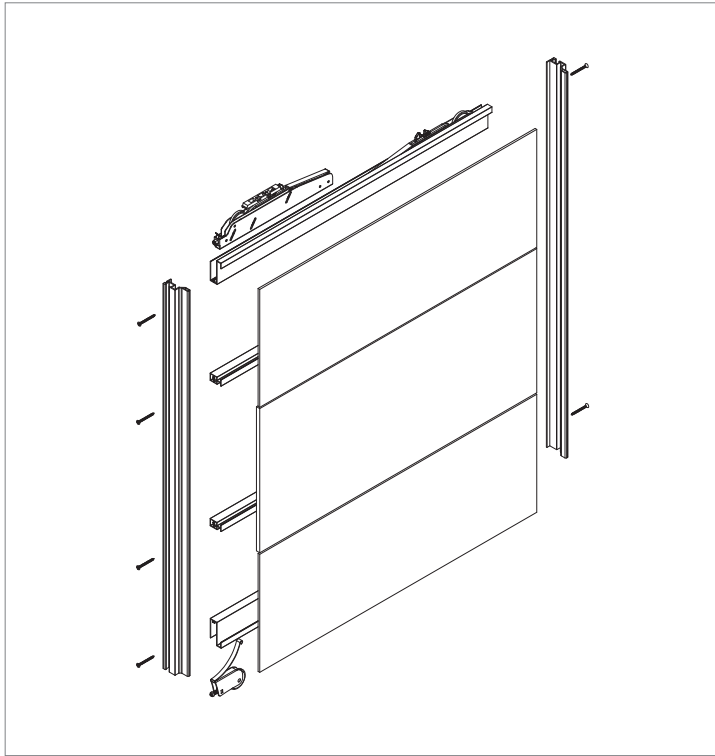

Rigel 1801

109-1801

60 KG AYARLI ALÜMİNYUM RAYLI PANO SİSTEMİ

60 KG ADJUSTABLE SLIDING ALUMINIUM PANEL / DOOR SYSTEM

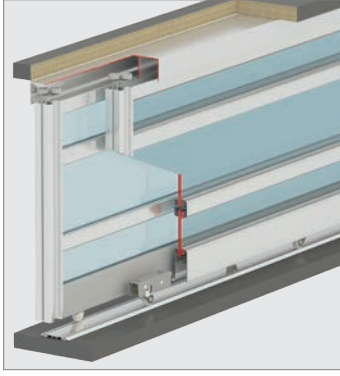

Yavaşlatıcı Alternatifi / Soft Closer Alternative

117-6700-1600 <<>> 117-6922-1610 <<>> 117-6921-1600 <<>>



109-1801 1 Takım İçeriği / 1 Kit Includes

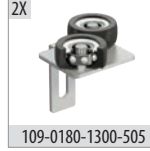
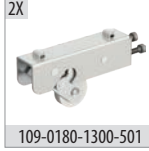
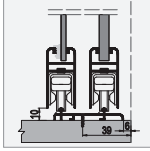

109-1812 1 Takım İçeriği / 1 Kit Includes

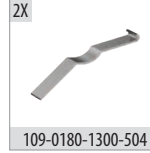
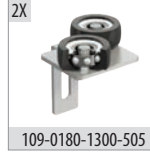
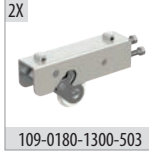
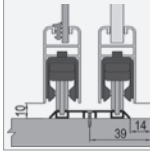

Alüminyum Fitilleri / Aluminium Wicks

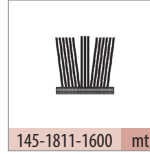

Ray Profilleri / Rail Profiles

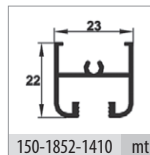
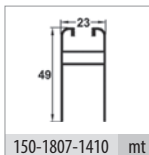
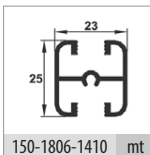
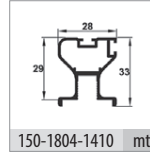
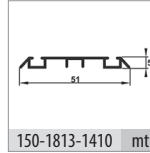
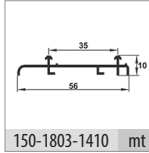
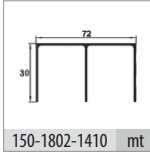

Teknik Detay / Technical Detail

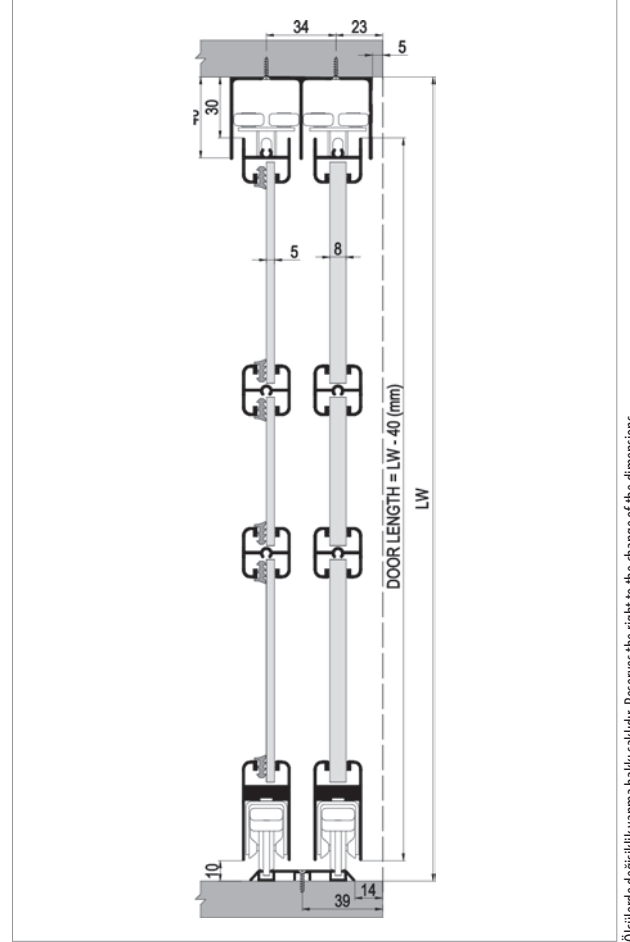

Ölçülerde değişiklik yapma hakkı saklıdır. Reserves the right to the change of the dimensions.

Kod / Code No	Açıklama / Description	Renk / Colour	Birim / Unit			Profil mt. / Profiles mt.	Bağ / Bnd.
109-1801-1300	60 Kg. Pano Dişi Teker Mekanizması / Panel System Beta	Galvaniz / Galvanized	1 Kapak / 1 Kit	48	1.152	- - -	-
109-1812-1300	60 Kg. Pano Erkek Teker Mekanizması / Panel System Gama	Galvaniz / Galvanized	1 Kapak / 1 Kit	48	1.152	- - -	-
145-1808-1600	Kapama Fitolu / Closing Wick	Gri / Grey	mt.	100	3.600	- - -	-
145-1810-1640	Cam Fitolu / Glass Wick	Şeffaf / Transparan	mt.	100	3.600	- - -	-
145-1811-1600	Kıl Fitolu / Ec-Wf Hair Wick	Gri / Grey	mt.	300	7.200	- - -	-
150-1802-1410	Alüminyum Üst Ray Profili / Aluminium Top Rail Profile	Eloksal / Mat Anodized	mt.	-	-	- -	6,0 -
150-1803-1410	Alüminyum Alt Ray Profili / Aluminium Bottom Rail Profile	Eloksal / Mat Anodized	mt.	-	-	- -	6,0 -
150-1813-1410	Alüminyum Alt Ray Profili / Aluminium Bottom Rail Profile	Eloksal / Mat Anodized	mt.	-	-	- -	6,0 -
150-1804-1410	Alüminyum Kulp Profili / Aluminium Handle Profile	Eloksal / Mat Anodized	mt.	-	-	- -	6,0 -
150-1806-1410	Alüminyum Orta Kayıt Profili / Aluminium Horizontal Central Profile	Eloksal / Mat Anodized	mt.	-	-	- -	6,0 -
150-1807-1410	Alüminyum Kapama Profili / Aluminium Closure Profile	Eloksal / Mat Anodized	mt.	-	-	- -	6,0 -
150-1852-1410	Alüminyum Üst Kayıt Profili / Aluminium Top Entry Profile	Eloksal / Mat Anodized	mt.	-	-	- -	6,0 -

Group 110

TvSlide[®]

Sürme Tv Ünite Serisi

Sliding Tv Unit Series



Bu serideki tüm ürünleri incelemek için
QR kodu okutabilirsiniz.

You can analyze the QR code to see all the
products in these series.

TvSlide 5100

110-5100

45 KG AYARLI TV ÜNİTESİ SÜRME KAPAK SİSTEMİ
45 KG ADJUSTABLE TV UNIT SLIDING DOOR SYSTEM

Özel Üretim
Special Production



Yavaşlatıcı Alternatifi / Soft Closer Alternative

117-6901-1610 <<>> 117-6950-1610 <<>>



110-5100 1 Takım İçeriği / 1 Kit Includes



Ray Profilleri / Rail Profiles

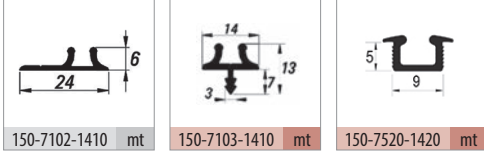

Opsiyonel Aksesuar / Optional Accessories



Teknik Detay / Technical Detail

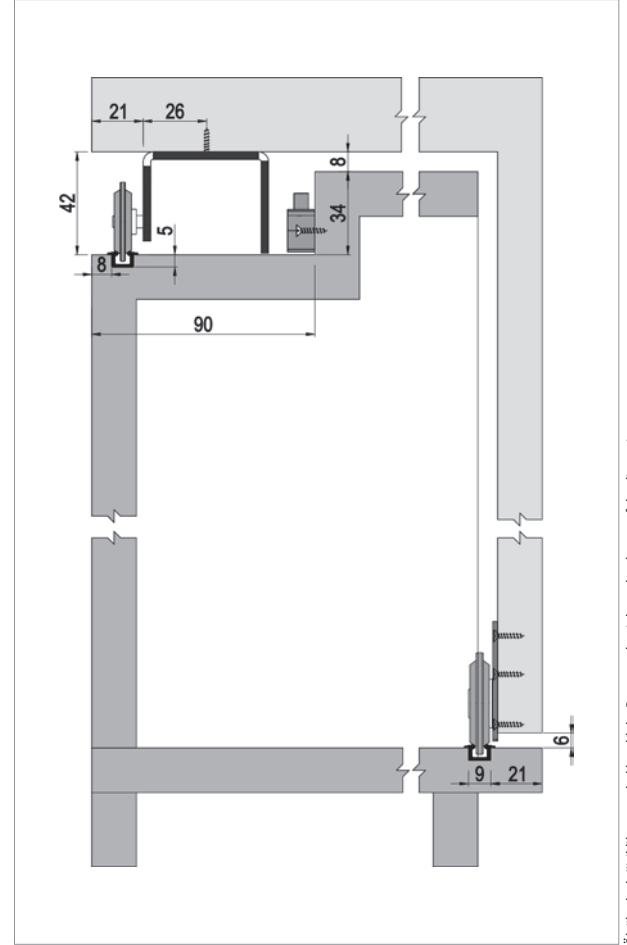

Ölçülerde değişiklik yapma hakkı saklıdır. Reserves the right to the change of the dimensions.

Kod / Code No	Açıklama / Description	Renk / Colour	Birim / Unit			Profil mt. / Profiles mt.	Bağ / Bnd.
110-5100-1300	45 Kg TV Ünitesi Sürme Kapak Sistemi / TV Unit Sliding Door System	Galvaniz / Galvanized	1 Kapak / 1 Kit	12	360	- - -	-
117-1011-1600	Plastik Ray Tapası / Plastic Rail Cap	Gri / Grey	1 Adet / 1 Pcs	1.000	120.000	- - -	-
150-7102-1410	Alüminyum Ray Profili / Aluminium Rail Profile	Eloksal / Mat Anodized	mt.	-	-	- - 3,0	20 ad/pcs
150-7103-1410	Alüminyum Ray Profili / Aluminium Rail Profile	Eloksal / Mat Anodized	mt.	-	-	- - 3,0	30 ad/pcs
150-7520-1410	Alüminyum Ray Profili / Aluminium Rail Profile	Eloksal / Mat Anodized	mt.	-	-	- - 3,0	30 ad/pcs

Group 117

Softline[®]

Yavaşlatıcı Serisi
Soft Closers Series



Bu serideki tüm ürünleri incelemek için
QR kodu okutabilirsiniz.

You can analyze the QR code to see all the
products in these series.



Softline Series

SINCE
1976









































Bearing
Systems

EN 1527
100.000
CYCLES
TEST



The
Sliding
System



	OEM Kod OEM Code	Ürün Kodu Product Code	Panel Tipi Panel Type	Fren Yönü Brake Direc.	Taşıma Kg Capacity Kg	Video
1	117-6710	Softline 6710			100	
2	117-6711	Softline 6711			100	
3	117-6666	Softline 6666			60	✓
4	117-6740	Softline 6740			60	
5	117-6940	Softline 6940			40	✓
6	117-6950	Softline 6950			50	✓
7	117-6970	Softline 6970			70	✓
8	117-6800	Softline 6800			80	✓
9	117-6810	Softline 6810			80	✓
10	117-6942	Softline 6942			50	
11	117-6901	Softline 6901			50	
12	117-6820	Softline 6820			80	✓
13	117-6990	Softline 6990			80	
14	117-6700	Softline 6700			80	
15	117-6922	Softline 6922			50	
16	117-6921	Softline 6921			70	
17	117-6959	Softline 6959			50	
18	117-1010	Softline 1010				
19	117-1011	Softline 1011				
20	117-1050	Softline 1050				
21	117-1220	Softline 1220				

• Verilen ölçüler bağlayıcı değildir. Önerilen kurulum ölçüleridir. Albatür ürün özelliklerinde haber vermeden değişiklik yapabilir.
• The given dimension are not binding. These are recommended assemble dimensions. Albatür can make alteration to product specification without notice.

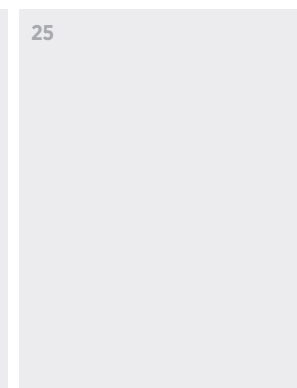
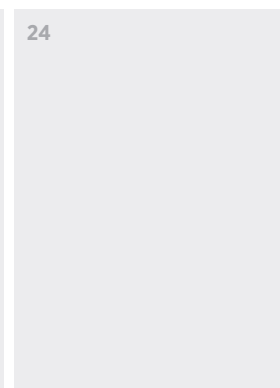
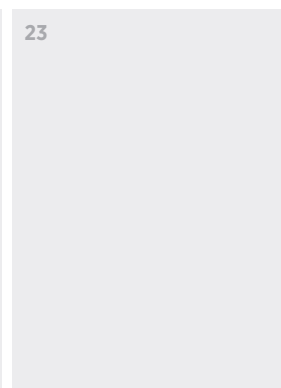
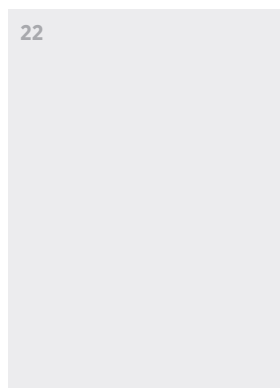

Neden yavaşlatıcı kullanılmalı?



Daha az gürültü

Yavaşlatma mekanizmalı kayar kapı ve kapaklar, yüksek konsantrasyon gerektiren mekanlarda istenmeyen sesleri önler ve gürültüsüz bir ortam sağlar.

Yüksek güvenlik

Yavaşlatma mekanizması, özellikle küçük çocukların, yaşlı ya da engellilerin olduğu ortamlarda parmakların kapı ve duvar veya kapak ve yan panel arasına sıkışma riskini engeller. Otomatik frenleme sistemi ve yavaş kapanma özelliği kapının veya kapağın çarparak kapanmasını engellediği için yüksek güvenlik sağlar.

Düşük maliyet, yüksek verim

Albatur yavaşlatıcı sistemleri, özellikle farklı tipte kayar kapı ve kapaklar için tasarlanmış ve uygulanmış ürünlerdir. Farklı kapı ve kayar kapı tiplerinin bir çoğu vidalanarak kolayca takılabilen Albatur yavaşlatma sistemleri ile yüksek maliyet gerektirmeden donatılabilir.

Malzeme dostu

Sürgülü kapı ve kapakların sertçe kapanması, mekanizmanın işlemlerini sağlayan makaraların, rayların, kapı ve kapak kanatlarının, profillerin, kasa ve pervazların aşırı yıpranmasına neden olur. Yavaşlatma mekanizması kayar kapı ve kapakların kasaya çarparak yıpranmasını önleyerek uzun yıllar güvenle kullanılmasını sağlar.

Why soft closer should be used?

Less Noise

Sliding doors and covers with soft closer mechanisms prevent unwanted sounds and provide a noiseless environment in places that require high concentration.

High Security

The Soft closer mechanism prevents the risk of fingers being caught between the door and the wall or the door and the side panel, especially in the presence of small children, the elderly or the disabled. The automatic braking system and slow closing feature provide high security as it prevents the door or cover from slamming shut.

Low cost, maximum efficiency

Albatur soft closer systems are designed and applied especially different types of sliding doors and covers. Most of the different door and sliding door types can be equipped with Albatur soft closer systems that can be easily screwed and without requiring high cost.

Material friendly

Fast closing of sliding doors and covers causes excessive wear of rollers, rails, door and cover wings, profiles, casing and moldings that enable the mechanism to work. The soft closing mechanism prevents the sliding doors and covers from being worn out by hitting the case, and ensures that they can be used safely for many years.



Softline 6710

117-6710

100 KG YAVAŞLATICI SİSTEM
100 KG SOFT CLOSER SYSTEM

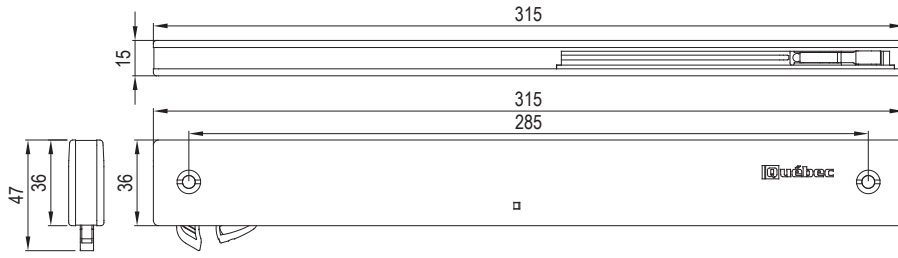
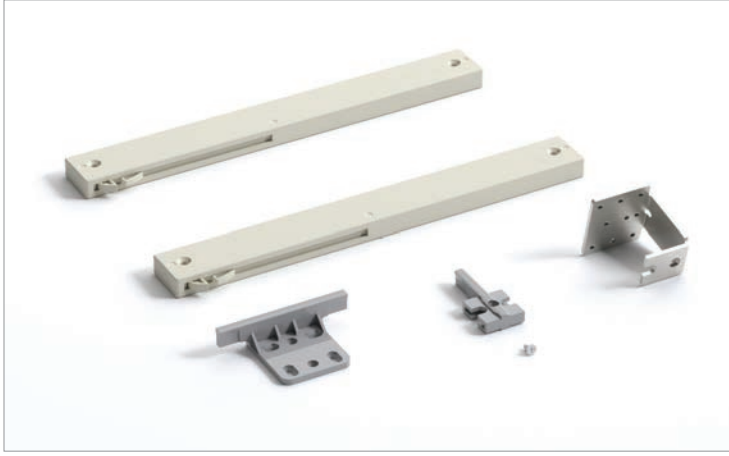

Kod / Code No	Açıklama / Description	Renk / Colour	Birim / Unit		
117-6710-1610	100 Kg Yavaşlatıcı Sistem / 100 Kg Soft Closer	Gri / Grey	1 Takım / 1 Kit	20	480

Softline 6711

117-6711

100 KG YAVAŞLATICI SİSTEM
100 KG SOFT CLOSER SYSTEM

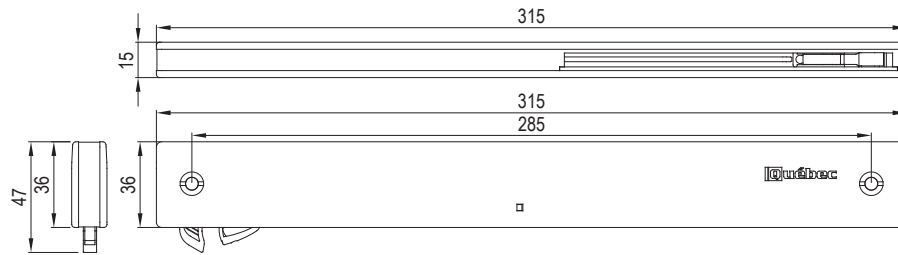
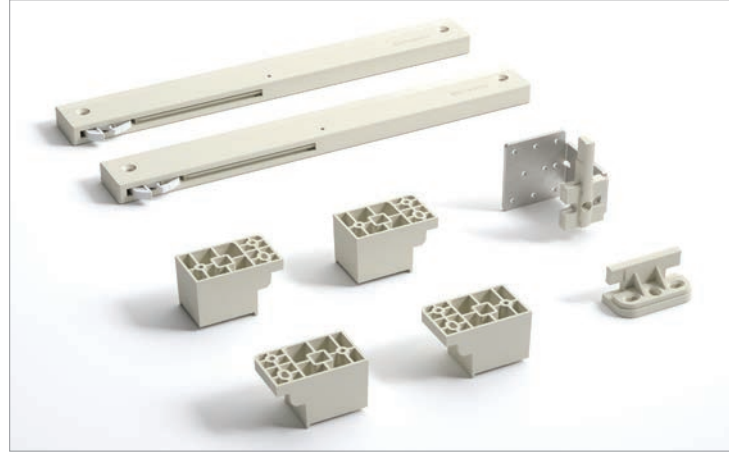

Kod / Code No	Açıklama / Description	Renk / Colour	Birim / Unit		
117-6711-1610	100 Kg Yavaşlatıcı Mekanizma / 100 Kg Soft Closer Mechanism	Gri / Grey	1 Takım / 1 Kit	24	576

Softline 6666

117-6666

60 KG YAVAŞLATICI SİSTEM
60 KG SOFT CLOSER SYSTEM

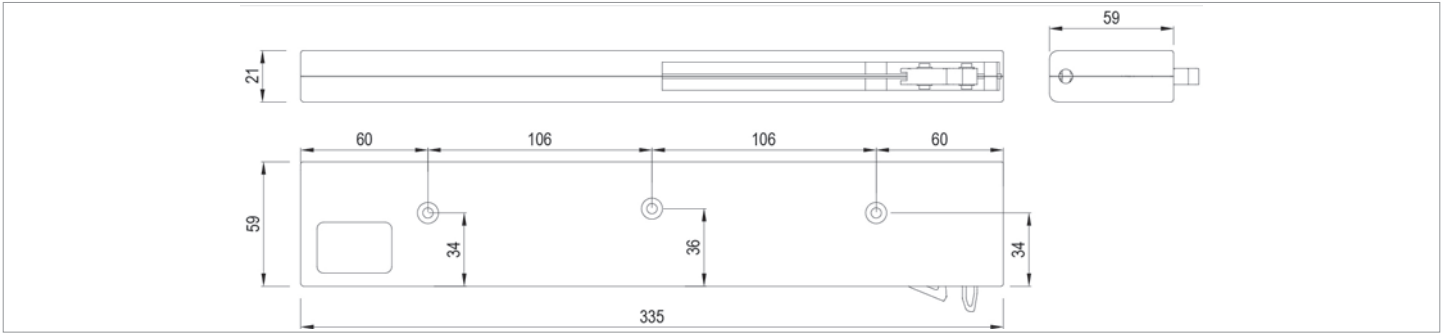
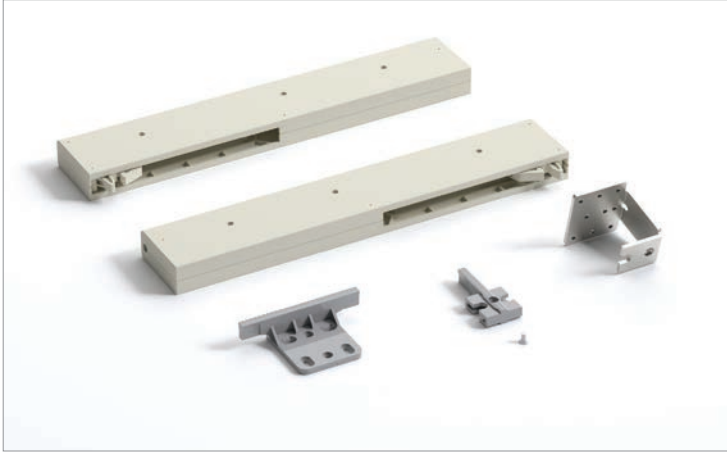

Kod / Code No	Açıklama / Description	Renk / Colour	Birim / Unit		
117-6666-1610	60 Kg Yavaşlatıcı Mekanizma / 60 Kg Soft Closer Mechanism	Gri / Grey	1 Takım / 1 Kit	30	360

Softline 6740

117-6740

60 KG YAVAŞLATICI SİSTEM
60 KG SOFT CLOSER SYSTEM

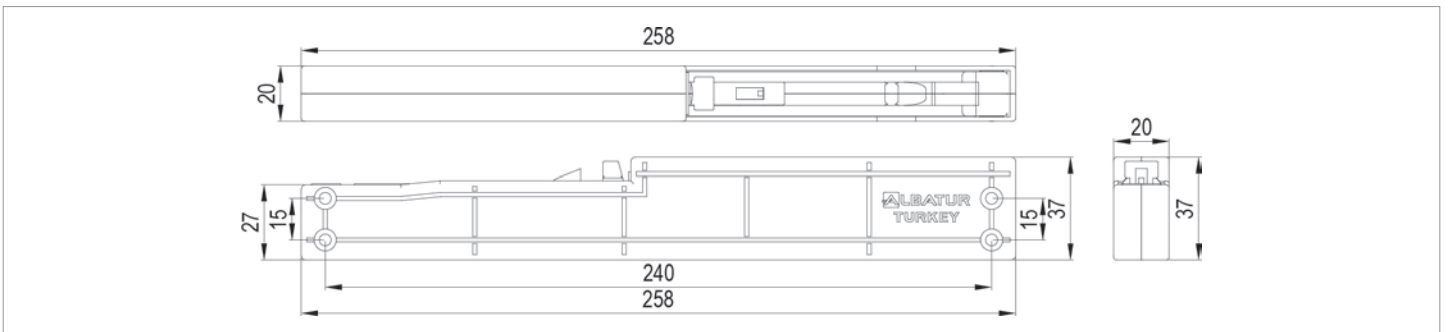

Kod / Code No	Açıklama / Description	Renk / Colour	Birim / Unit		
117-6740-1610	60 Kg Yavaşlatıcı Mekanizma / 60 Kg Soft Closer Mechanism	Gri / Grey	1 Adet / 1 Pcs.	60	1.250

Softline 6940

117-6940

40 KG YAVAŞLATICI SİSTEM
40 KG SOFT CLOSER SYSTEM

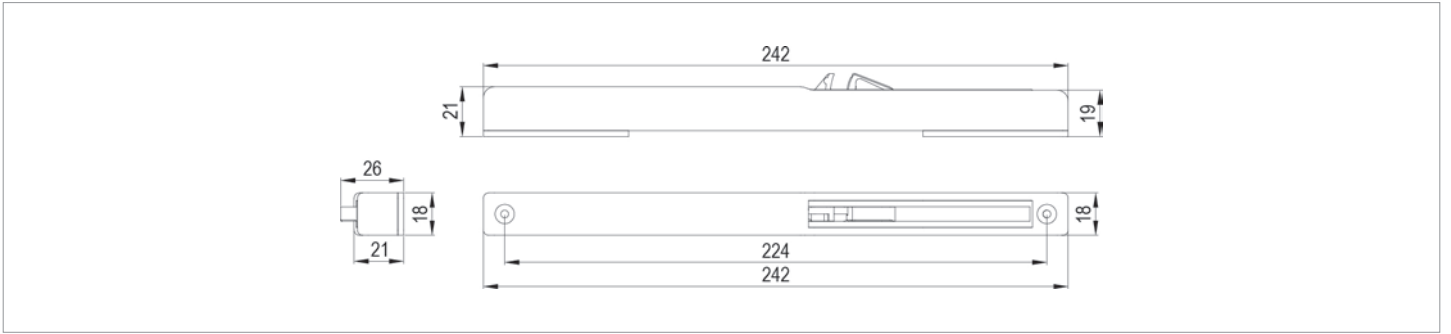

Kod / Code No	Açıklama / Description	Renk / Colour	Birim / Unit		
117-6940-1600	40 Kg Yavaşlatıcı Mekanizma / 40 Kg Soft Closer Mechanism	Gri / Grey	1 Takım / 1 Kit	50	1.250

Softline 6950

117-6950

50 KG YAVAŞLATICI SİSTEM
50 KG SOFT CLOSER SYSTEM

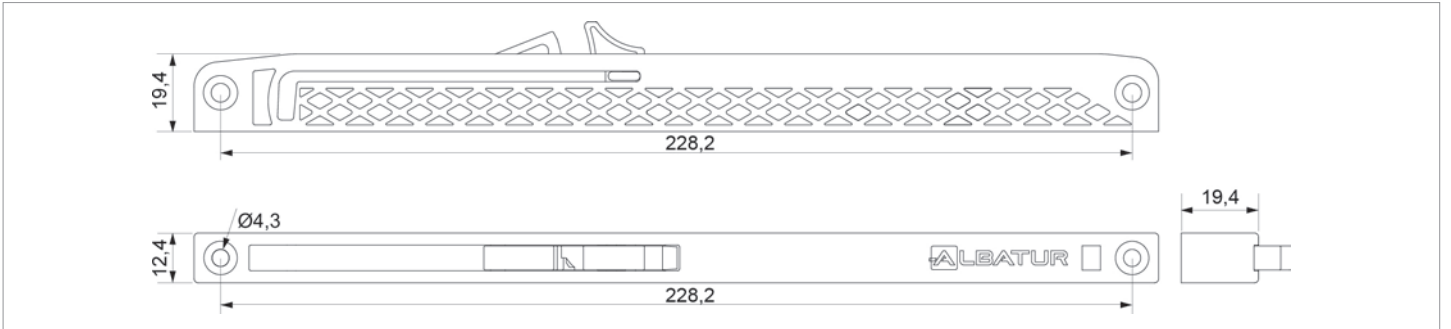
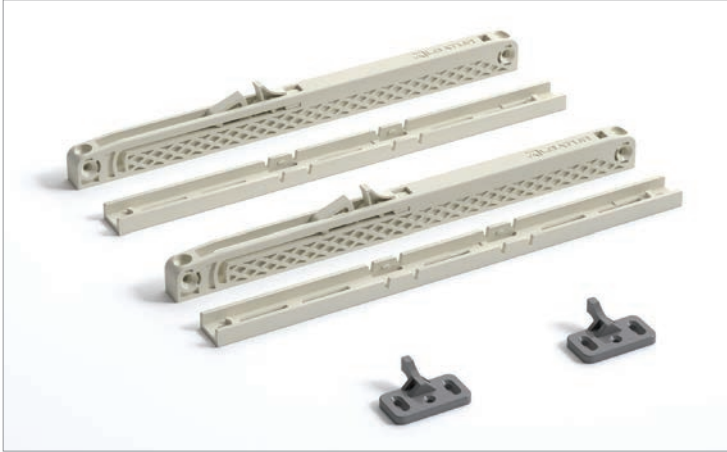

Kod / Code No	Açıklama / Description	Renk / Colour	Birim / Unit		
117-6950-1610	50 Kg Yavaşlatıcı Mekanizma / 50 Kg Soft Closer Mechanism	Gri / Grey	1 Takım / 1 Kit	50	1.250

Softline 6970

117-6970

70 KG YAVAŞLATICI SİSTEM
70 KG SOFT CLOSER SYSTEM

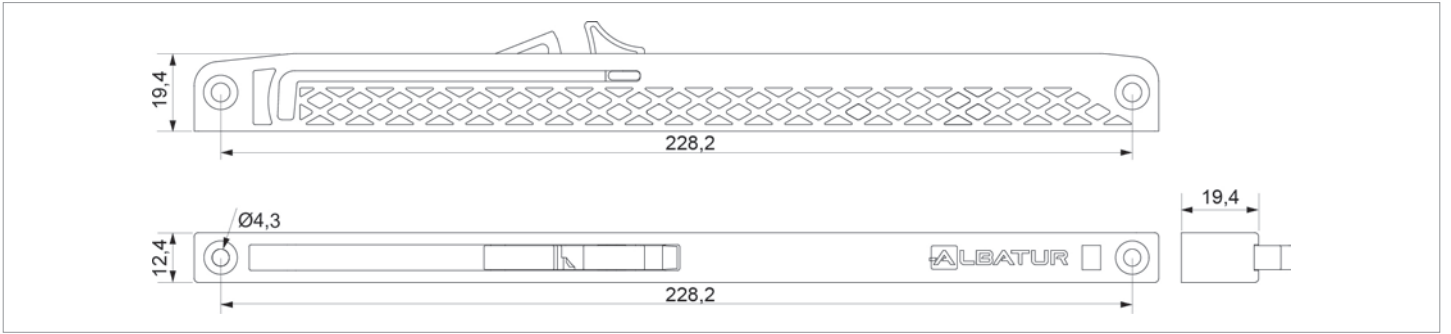

Kod / Code No	Açıklama / Description	Renk / Colour	Birim / Unit		
117-6970-1610	70 Kg Yavaşlatıcı Mekanizma / 70 Kg Soft Closer Mechanism	Gri / Grey	1 Takım / 1 Kit	50	1.250

Softline 6800

117-6800

80 KG YAVAŞLATICI SİSTEM
80 KG SOFT CLOSER SYSTEM

Özel Üretim
Special Production

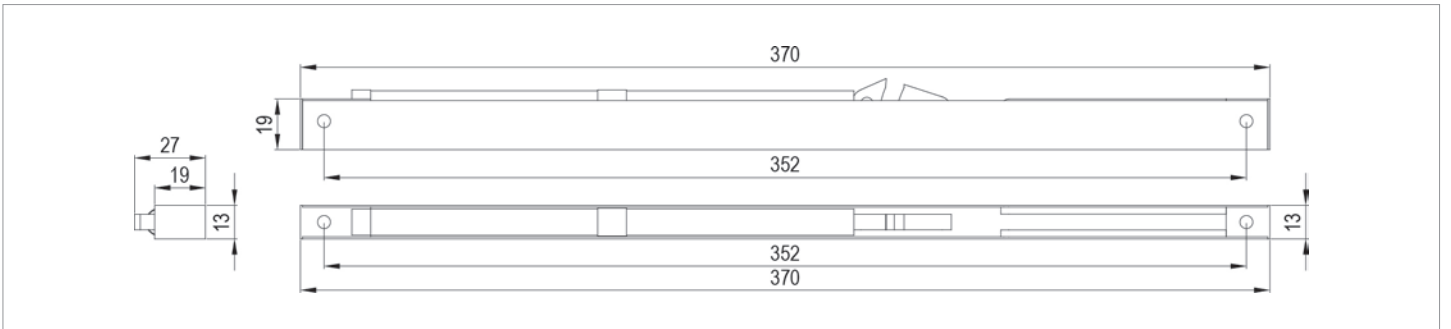

Kod / Code No	Açıklama / Description	Renk / Colour	Birim / Unit		
117-6800-1300	80 Kg Yavaşlatıcı Mekanizma / 80 Kg Soft Closer Mechanism	Galvaniz / Galvanized	1 Takım / 1 Kit	24	576

Softline 6810

117-6810

80 KG YAVAŞLATICI SİSTEM
80 KG SOFT CLOSER SYSTEM

Özel Üretim
Special Production

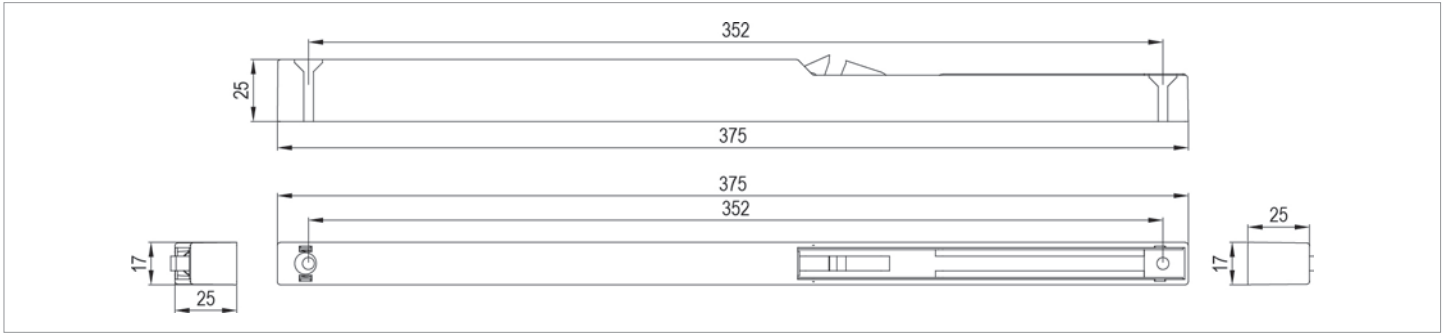

Kod / Code No	Açıklama / Description	Renk / Colour	Birim / Unit		
117-6810-1600	80 Kg Yavaşlatıcı Mekanizma / 80 Kg Soft Closer Mechanism	Gri / Grey	1 Takım / 1 Kit	24	576

Softline 6942

117-6942

50 KG YAVAŞLATICI SİSTEM
50 KG SOFT CLOSER SYSTEM

Özel Üretim
Special Production

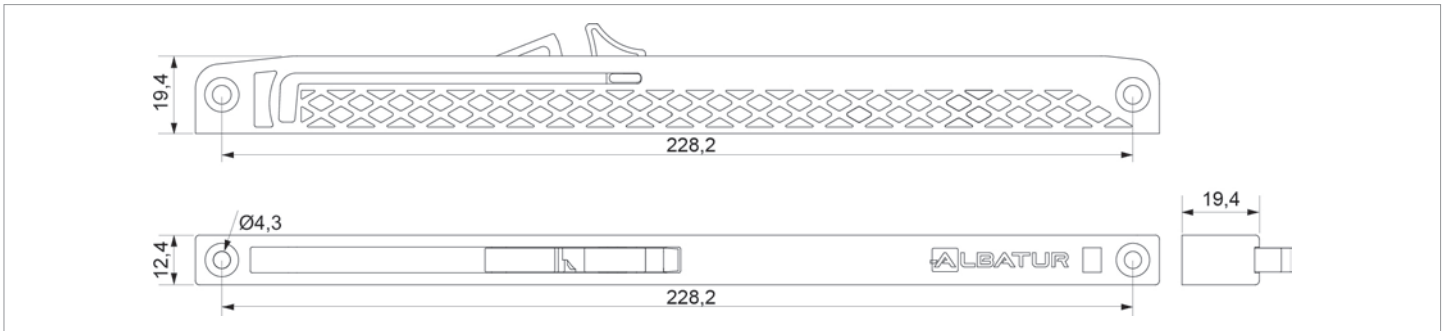

Kod / Code No	Açıklama / Description	Renk / Colour	Birim / Unit		
117-6942-1610	50 Kg Yavaşlatıcı Mekanizma / 50 Kg Soft Closer Mechanism	Gri / Grey	1 Takım / 1 Kit	50	1.250

Softline 6901

117-6901

50 KG YAVAŞLATICI SİSTEM
50 KG SOFT CLOSER SYSTEM

Özel Üretim
Special Production

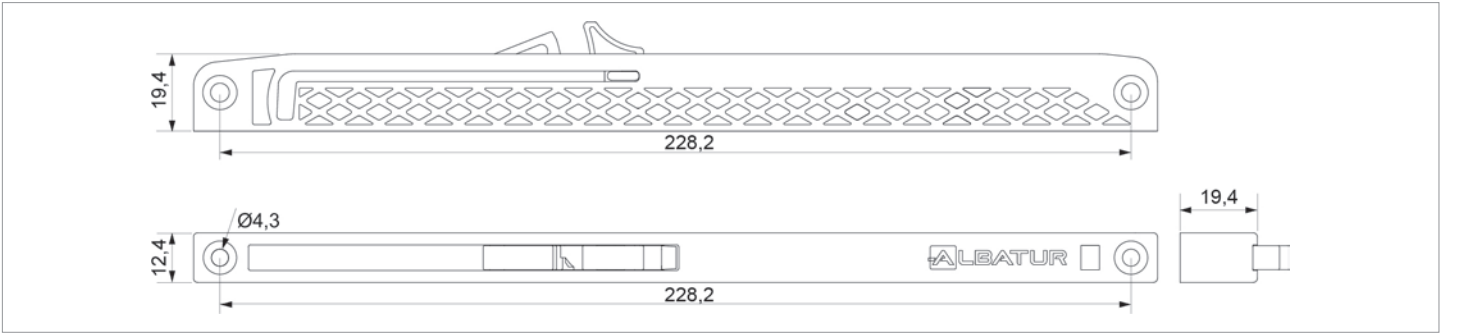

Kod / Code No	Açıklama / Description	Renk / Colour	Birim / Unit		
117-6901-1610	50 Kg Yavaşlatıcı Mekanizma / 50 Kg Soft Closer Mechanism	Gri / Grey	1 Takım / 1 Kit	50	1.250

Softline 6820

117-6820

80 KG YAVAŞLATICI SİSTEM
80 KG SOFT CLOSER SYSTEM

Özel Üretim
Special Production

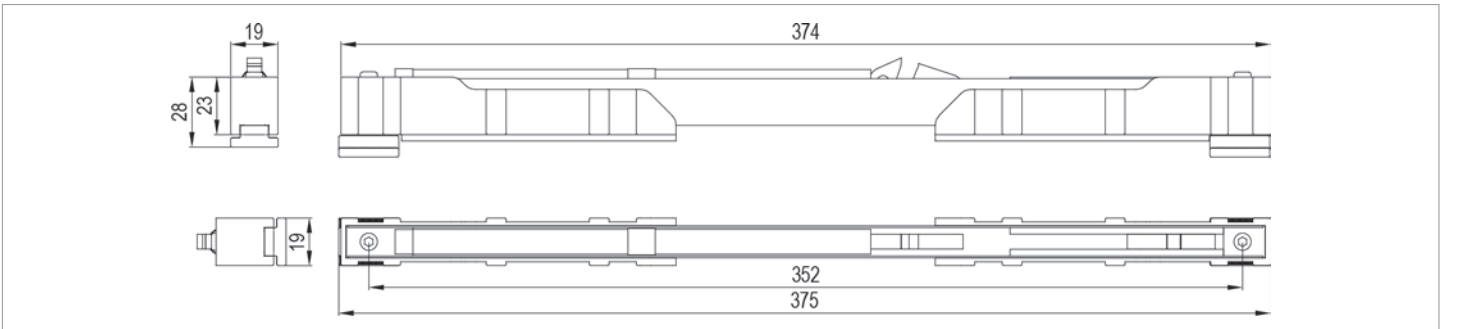

Kod / Code No	Açıklama / Description	Renk / Colour	Birim / Unit		
117-6820-1600	80 Kg Yavaşlatıcı Mekanizma / 80 Kg Soft Closer Mechanism	Gri / Grey	1 Takım / 1 Kit	24	576

Softline 6990

117-6990

80 KG YAVAŞLATICI SİSTEM
80 KG SOFT CLOSER SYSTEM

Özel Üretim
Special Production

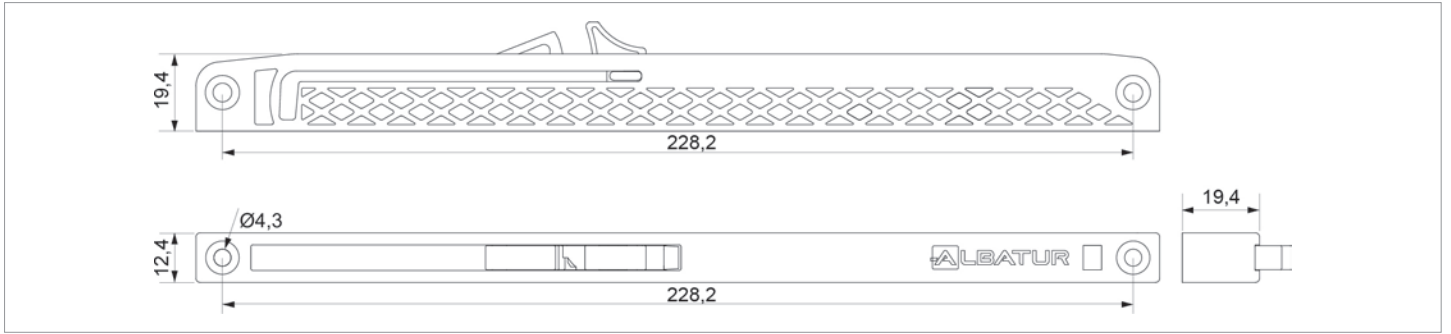

Kod / Code No	Açıklama / Description	Renk / Colour	Birim / Unit		
117-6990-1610	80 Kg Yavaşlatıcı Mekanizma / 80 Kg Soft Closer Mechanism	Gri / Grey	1 Takım / 1 Kit	50	1.250

Softline 6700

117-6700

80 KG YAVAŞLATICI SİSTEM
80 KG SOFT CLOSER SYSTEM

Özel Üretim
Special Production

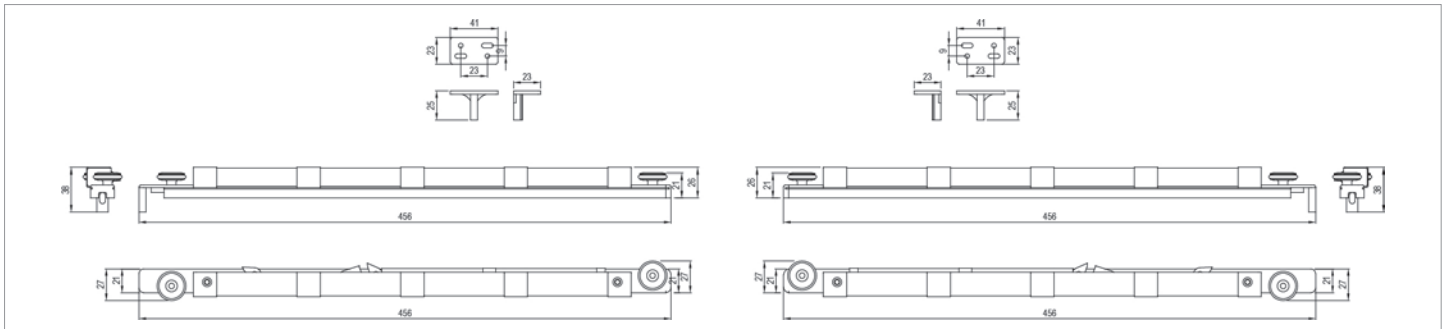
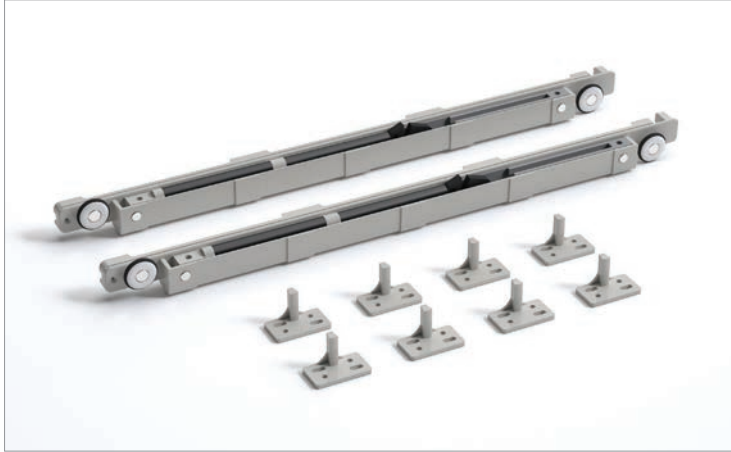

Kod / Code No	Açıklama / Description	Renk / Colour	Birim / Unit		
117-6700-1600	80 Kg Yavaşlatıcı Mekanizma / 80 Kg Soft Closer Mechanism	Gri / Grey	1 Takım / 1 Kit	24	576

Softline 6922

117-6922

50 KG YAVAŞLATICI SİSTEM
50 KG SOFT CLOSER SYSTEM

Özel Üretim
Special Production

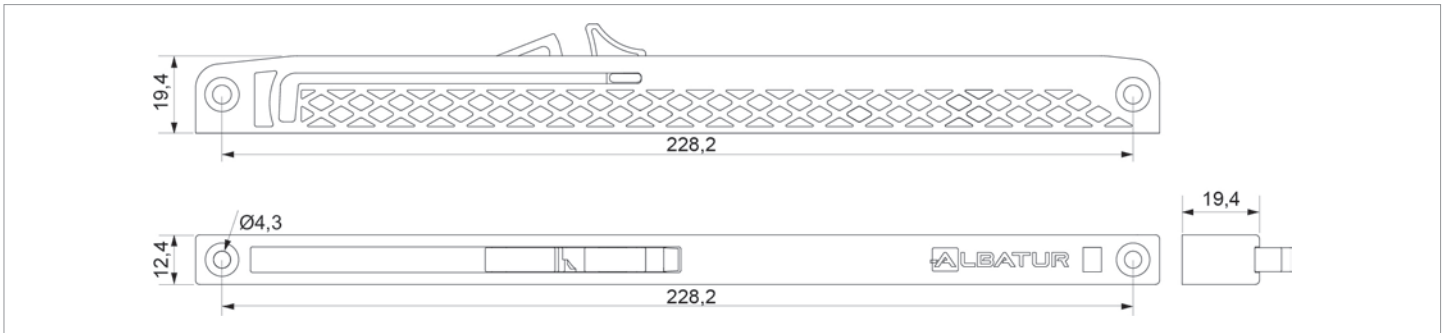
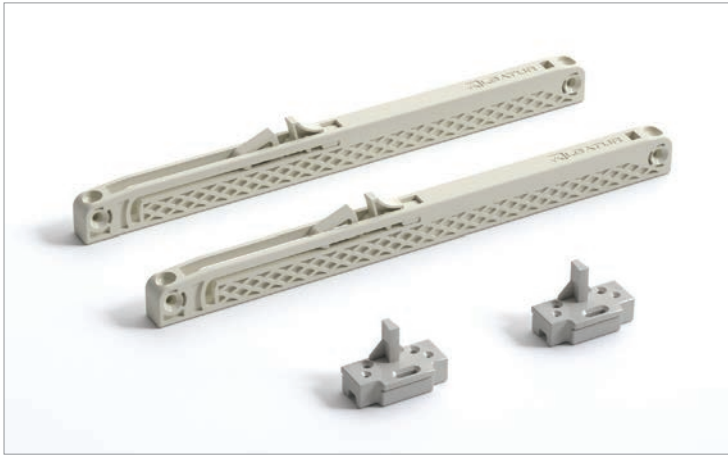

Kod / Code No	Açıklama / Description	Renk / Colour	Birim / Unit		
117-6922-1610	50 Kg Yavaşlatıcı Mekanizma / 50 Kg Soft Closer Mechanism	Gri / Grey	1 Takım / 1 Kit	50	1.250

Softline 6921

117-6921

70 KG YAVAŞLATICI SİSTEM
70 KG SOFT CLOSER SYSTEM

Özel Üretim
Special Production

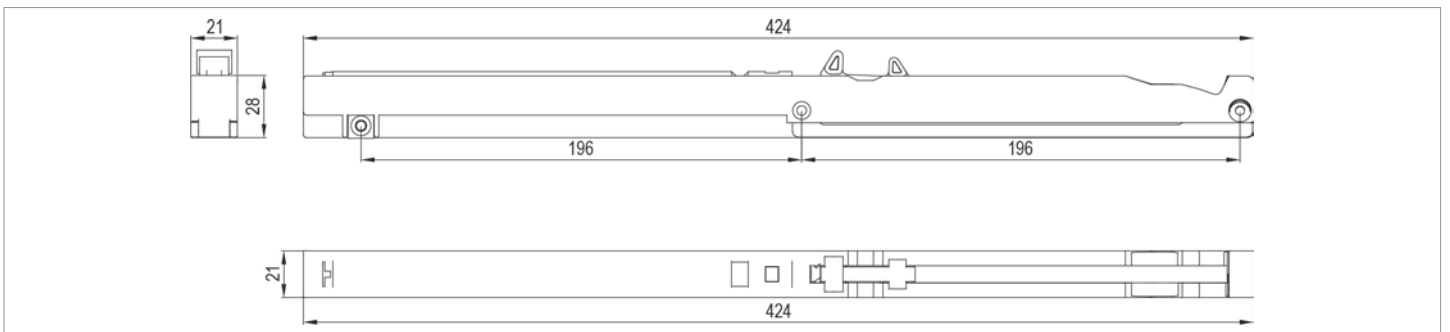



Kod / Code No	Açıklama / Description	Renk / Colour	Birim / Unit		
117-6921-1600	70 Kg Yavaşlatıcı Mekanizma / 70 Kg Soft Closer Mechanism	Gri / Grey	1 Takım / 1 Kit	24	1.200

Softline 6959

117-6959

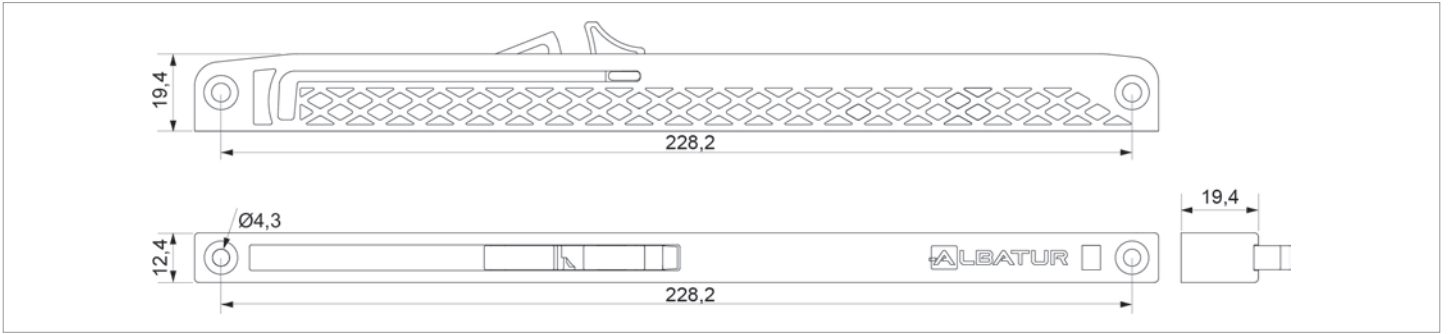
50 KG YAVAŞLATICI SİSTEM
50 KG SOFT CLOSER SYSTEM



Kod / Code No	Açıklama / Description	Renk / Colour	Birim / Unit		
117-6959-1610	50 Kg Yavaşlatıcı Mekanizma / 50 Kg Soft Closer Mechanism	Gri / Grey	1 Takım / 1 Kit	50	1.250



Softline **Series**

Softline 1010

117-1010

PLASTİK STOPER
PLASTIC STOPPER

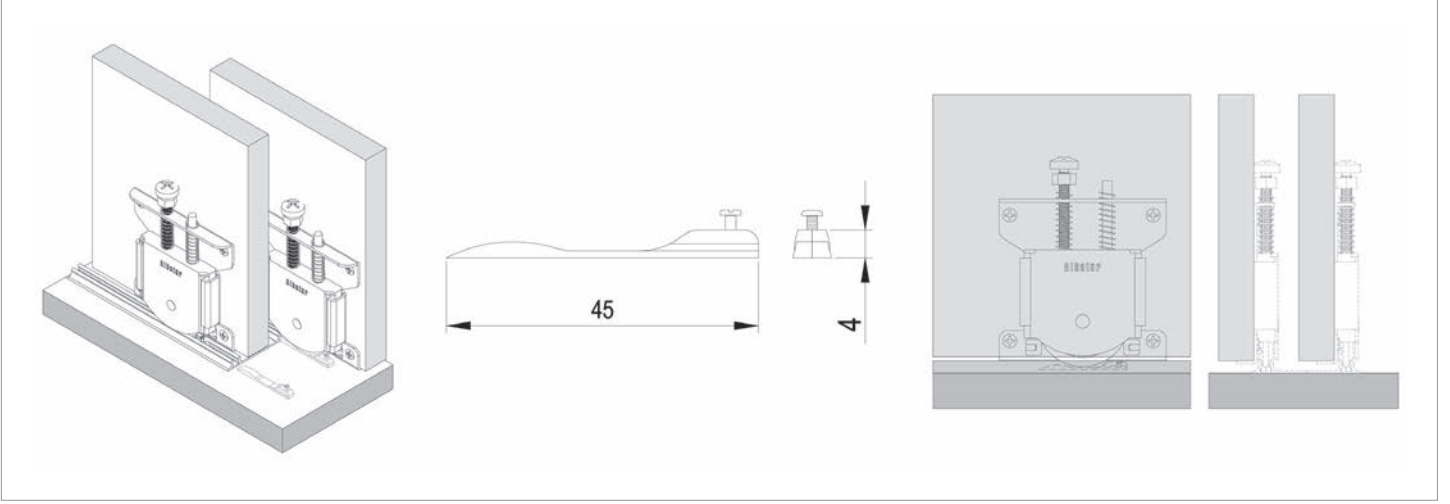
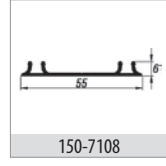
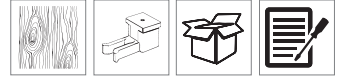

Kod / Code No	Açıklama / Description	Renk / Colour	Birim / Unit		
117-1010-1600	Plastik Stoper Elemanı / Plastic Stopper Element	Gri / Grey	1 Adet / 1 Pcs.	XXXX	XXXX

Softline 1011

117-1011

PROFİL PLASTİK RAY TAPASI
PROFILE PLASTIC RAIL PLUG

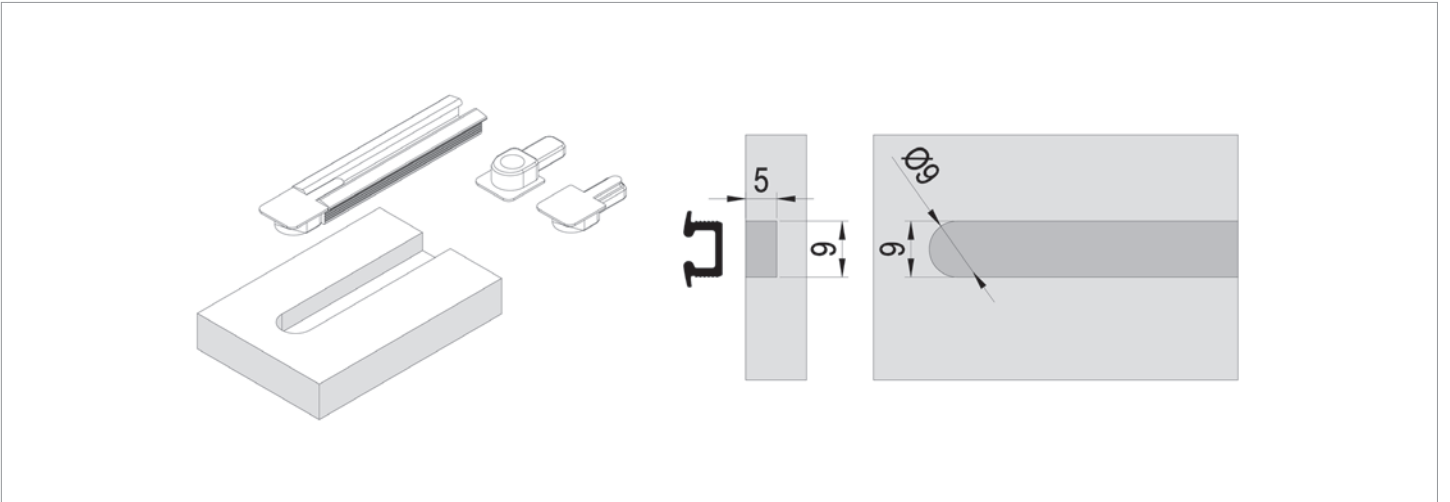
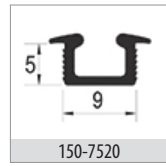
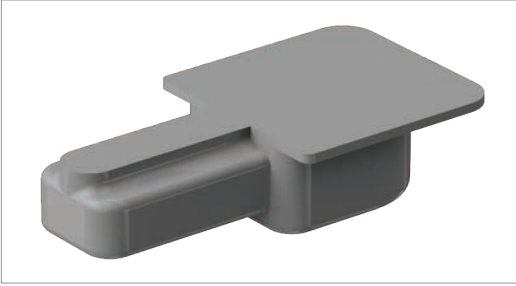

Kod / Code No	Açıklama / Description	Renk / Colour	Birim / Unit		
117-1011-1600	Plastik Stoper Elemanı / Plastic Stopper Element	Gri / Grey	1 Adet / 1 Pcs.	XXXX	XXXX

Softline 1050

117-1050

PLASTİK KAPAK ÇARPMA ÖNLEYİCİ
PLASTIC COVER ANTI-SHOCK

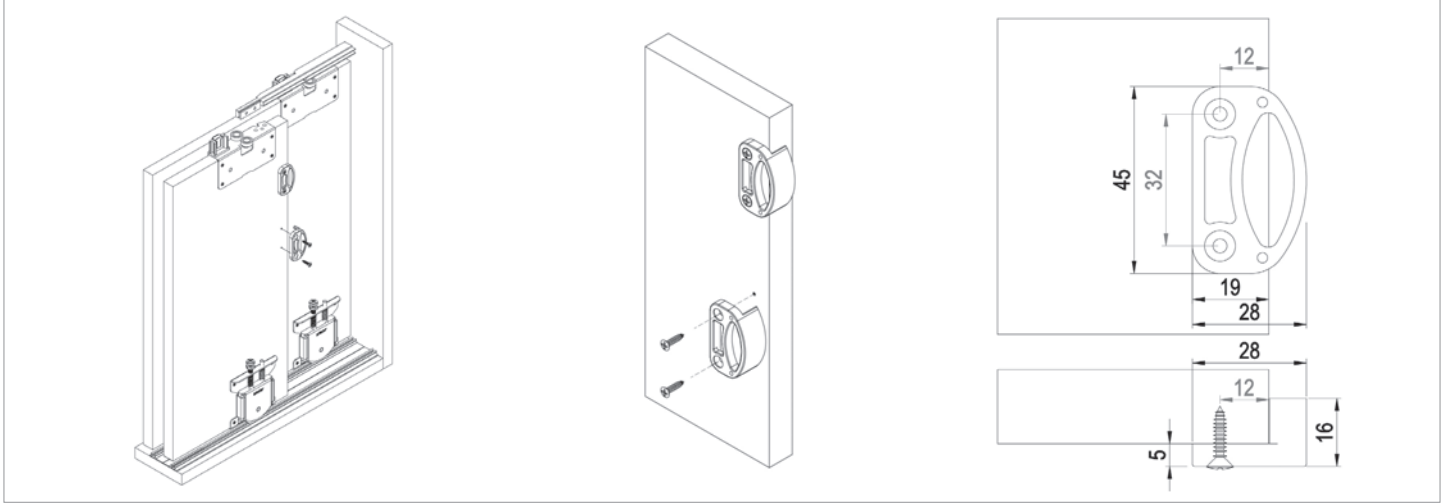
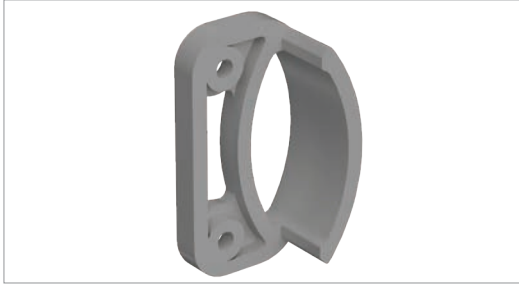

Kod / Code No	Açıklama / Description	Renk / Colour	Birim / Unit		
117-1050-1600	Plastik Stoper Elemanı / Plastic Stopper Element	Gri / Grey	1 Adet / 1 Pcs.	XXXX	XXXX

Softline 1220

117-1220

PROFİL PLASTİK RAY TAPASI
PROFILE PLASTIC RAIL PLUG

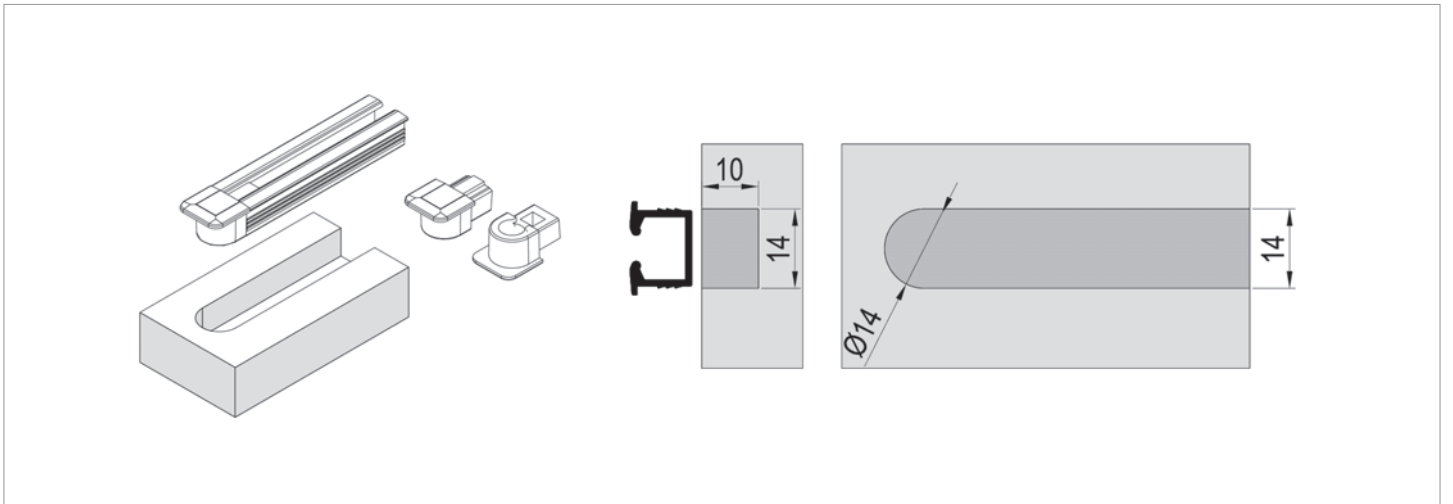
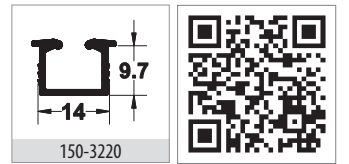
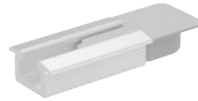
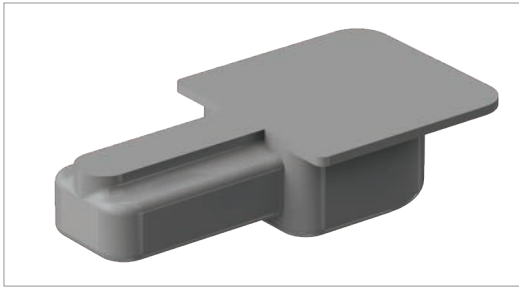

Kod / Code No	Açıklama / Description	Renk / Colour	Birim / Unit		
117-1220-1600	Plastik Stoper Elemanı / Plastic Stopper Element	Gri / Grey	1 Adet / 1 Pcs.	XXXX	XXXX

Group 118

Pulltens[®]

Çek-Ger Serisi

Pull & Tension Series

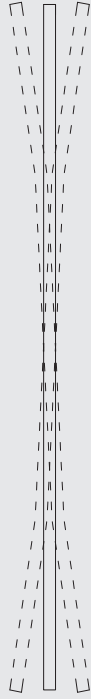

Bu serideki tüm ürünleri incelemek için
QR kodu okutabilirsiniz.

You can analyze the QR code to see all the
products in these series.

1



118-0001

2



118-0002

3



118-0005

4



118-0006

5



118-0007

6



118-0009

7



118-0011

8



118-0012

9

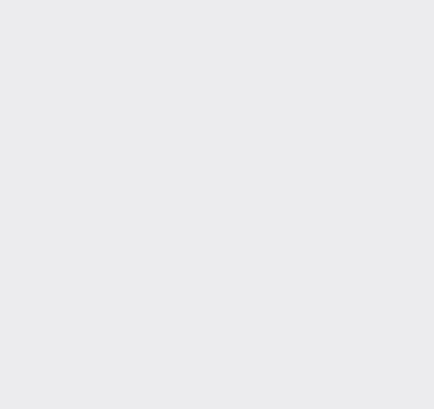

10

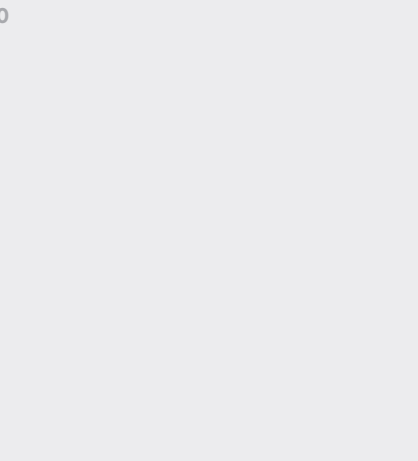

11

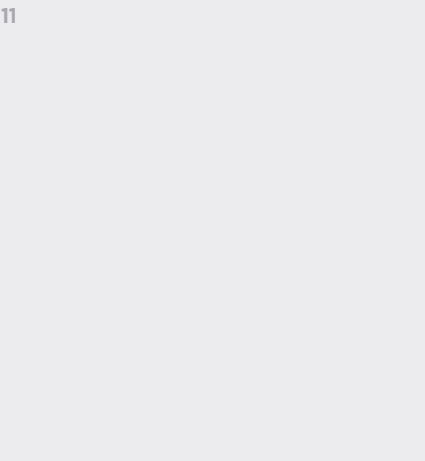

12

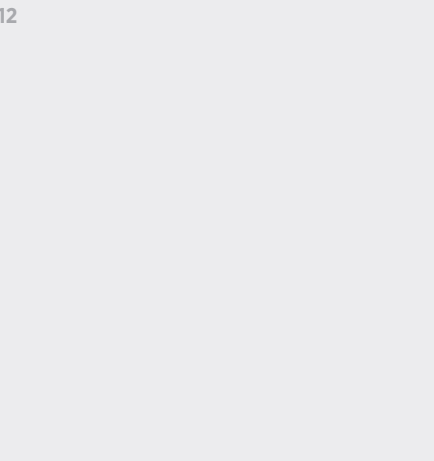

	OEM Kod OEM Code	Ürün Kodu Product Code	Başlık Materyali Head Material	Standart Boy Standard Size (mm)	Video	Gövde Surface	Montaj Şekli Assembly Type	Tavsiye Edilen Kullanım Adeti Recommended Usage Pieces
1	Pulltens 1	118-0001	Metal	1940	✓	Demir / Iron	Gömme / Internal	40 cm >2 Pcs.
2	Pulltens 2	118-0002	Metal	1920	✓	Demir / Iron	Gömme / Internal	40 cm >2 Pcs.
3	Pulltens 5	118-0005	Plastik / Plastic	1910	✓	Demir / Iron	Gömme / Internal	40 cm >2 Pcs.
4	Pulltens 6	118-0006	Alüminyum / Aluminium	2000	✓	Alüminyum / Aluminium	Gömme / Internal	40 cm >2 Pcs.
5	Pulltens 7	118-0007	Zamak / Zinc	2000	✓	Alüminyum / Aluminium	Gömme / Internal	40 cm >2 Pcs.
6	Pulltens 9	118-0009	Alüminyum / Aluminium	2000	✓	Mil Alüminyum / Aluminium	Yüzeyden / External	40 cm >2 Pcs.
7	Pulltens 11	118-0011	Zamak / Zinc	1850	✓	Demir / Iron	Gömme / Internal	40 cm >2 Pcs.
8	Pulltens 12	118-0012	Metal	1838	✓	Demir / Iron	Gömme / Internal	40 cm >2 Pcs.

• Verilen ölçüler bağlayıcı değildir. Önerilen kurulum ölçüleridir. Albatır ürün özelliklerinde haber vermeden değişiklik yapabilir.

• The given dimension are not binding. These are recommended asamble dimensions. Albatır can make alteration to product specification without notice.

Neden ÇEK-GER kullanılmalı?

Hava şartları, rutubet, taşıma ve istifleme (depolama) nedeniyle MDF, sunta ve ahşap kapak malzemelerde kalıcı burkulma ve atıklık oluşabilmektedir. Ayrıca ahşap üzerine eklenen cam, ayna ve diğer aksesuarlar kapağın düzlemselliğine etken faktörlerdir. Kapaklarımızda bu atıklığı gergi sistemleri ve yan duvarlarda kullanacağımız alüminyum dikme kulplar (dik düzlemde ahşabın düzlemselliğini sağlayabilecek kesit ve atık oluşabilecek eksende ahşabın mukavemetinden daha etkin dirençli alüminyum yada metal ekstrüde profil ve aksesuarlar) ile çözmek mümkündür. Lakin dikme kulplar ile çözüm üretim esnasında etkin olmasına karşın, depolama şartlarına bağlı olarak 1 yada 2 ay sonra açılan ambalajlı ürünlerde yetersiz kaldığı görülmektedir. Bu tip ürün gruplarında çekger mekanizmaları kapaktaki atıklıkları, kullanıldıkları eksen yönünde çözüme kavuşturmaktadır. En ölçüsü 40 cm e kadar olan kapaklarda merkezden bir adet, daha büyük en ölçülerinde iki adet çekger kullanımı önerilmektedir. Cam ve ayna yapıştırılan kapaklarda çekger kullanımında dikkat edilmesi gereken bazı hususlar: Cam, ayna v.s. grubu ahşap panele yapıştırılırken ahşap panel kesinlikle çok hassas ve düz bir zeminde tutulmalıdır. Aksi takdirde yapıştırılma anındaki tüm atıklık daha sonra çekger gergi yada kulp marifeti ile düzletilemez bir durum oluşturmaktadır.

Why to Prefer Pull-Tension ?

On the wooden door in materials, MDF materials and chipboard materials can be permanent strain and swelling. Because of bad weather condition, humidity, transport and storage factors. Also other factors effecting the flatness of the wooden covers; installing glass, mirror and other accessories on the wooden panel. Its possible to solve this swelling problem for using Pull & Tension Equipments and using the pillar aluminium handles on the side walls of the wooden panel. However its effective solution using the pillar aluminium handles during the production but it seems to be inadequate solution if the products keep in storage 1 or 2 months. In this type of products group, Pull & Tension mechanism resolve this swelling problem on the cover using the their axis direction side. Width measure to 40 cm covers, from the center of the cover 1 pcs Pul & Tension should be using, more larger width measure 2 pcs Pull & Tension recommended. Issues to be considered Pull & Tension when used glass and mirros on the cover: When use glass and mirros on the wooden cover panel; panel definitely should be keep on the very sensitive and flat ground. Otherwise during the installing glass or mirros, at this moment swelling that may occur unimprovable situation.

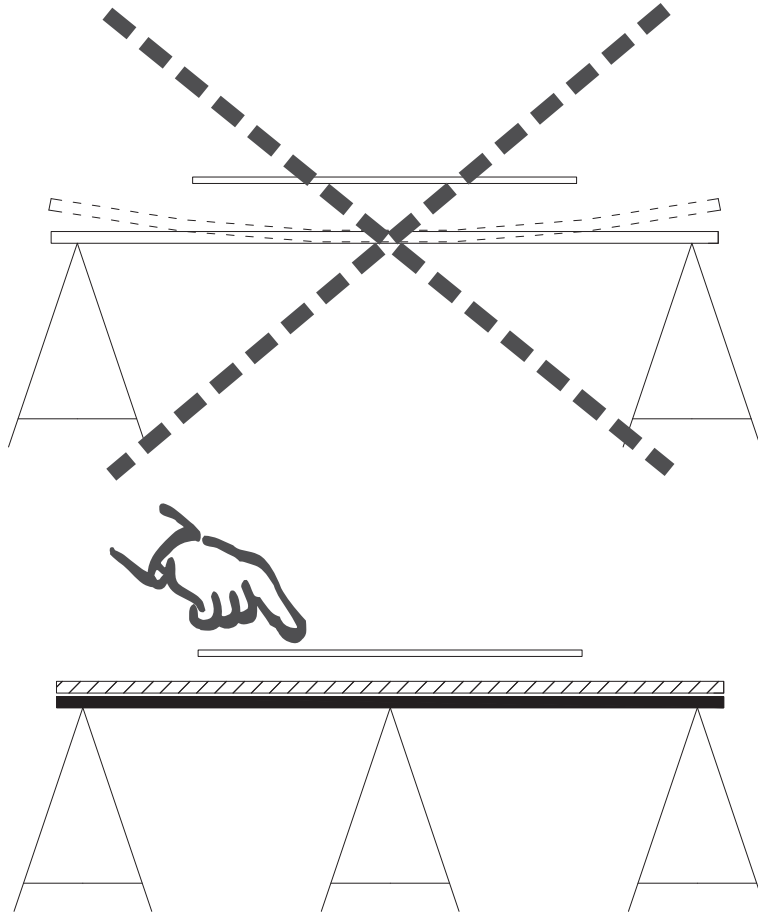

Cam, ayna v.s. grubu ahşap panele yapıştırılırken, panel kesinlikle çok hassas ve düz bir zeminde tutulmalıdır. Aksi takdirde yapıştırılma anındaki tüm atıklık, daha sonra çekger gergi yada kulp marifeti ile düzletilemez bir durum oluşturur.

While the installation glass, mirror etc.. on the panel, the panel must be kept on a very sensitive and flat surface. If not, all the bending while the stick on the panel; later on, it cannot be corrected with the tension or handle

Pulltens 1

118-0001

METAL ÇEK-GER
PULL & TENSION METAL

■ 118-0001

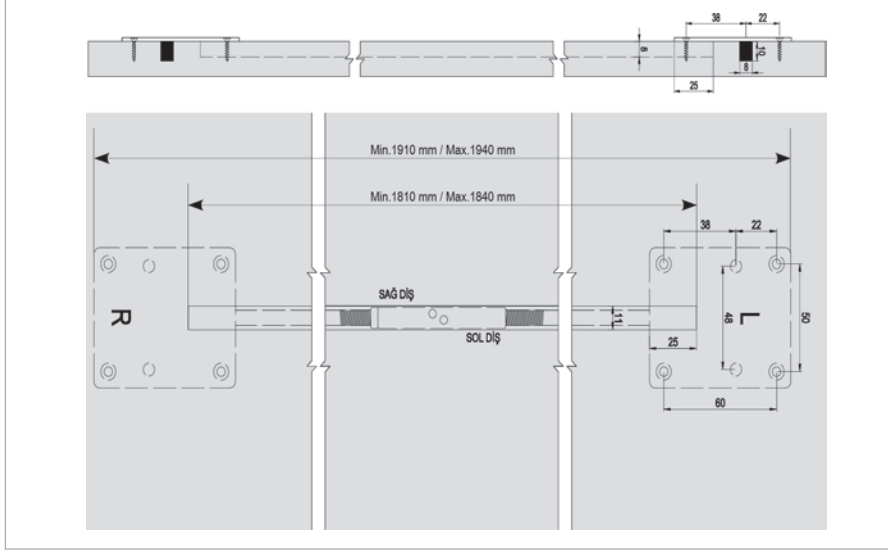

Ölçülerde değişiklik yapma hakkı saklıdır. Reserves the right to the change of the dimensions.



■ Bilgi / Information

- Birim adet fiyatlandır.
- 40 cm'den geniş kapaklarda 2 adet kullanımı önerilir.
- Özel ölçü için müşteri temsilciniz ile görüşünüz.
- Maksimum kapak yüksekliği 2.200 mm tavsiye edilir.
- Minimum kapak yüksekliği 1.700 mm tavsiye edilir.

- Unit Prices
- More than 40 cm width doors, recommended to use 2 pcs
- For special size please contact customer representative.
- Maximum door height is 2.200 mm recommended.
- Minimum door height is 1.700 mm recommended.

Kod / Code No	Açıklama / Description	Renk / Colour	Birim / Unit		
118-0001-1600	CG 01 - Metal Başlı Çek-Ger Mekanizması - Pull & Tension Equipments - Metal	Galvaniz / Galvanized	1 Adet / 1 Pcs	24	384

Pulltens 2

118-0002

METAL BOY ÇEK-GER
PULL & TENSION METAL

■ 118-0002

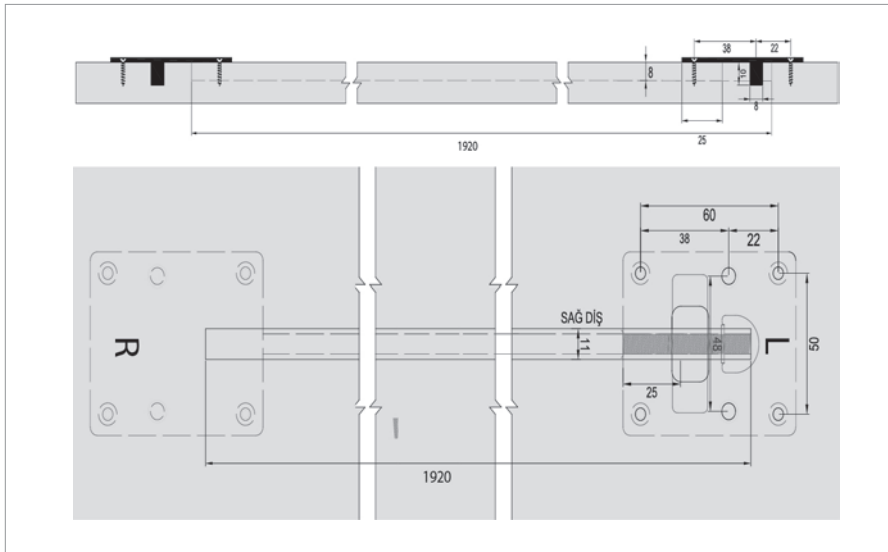

Ölçülerde değişiklik yapma hakkı saklıdır. Reserves the right to the change of the dimensions.



■ Bilgi / Information

- Birim adet fiyatlandır.
- 40 cm'den geniş kapaklarda 2 adet kullanımı önerilir.
- Özel ölçü için müşteri temsilciniz ile görüşünüz.
- Maksimum kapak yüksekliği 2.200 mm tavsiye edilir.
- Minimum kapak yüksekliği 1.800 mm tavsiye edilir.

- Unit Prices
- More than 40 cm width doors, recommended to use 2 pcs
- For special size please contact customer representative.
- Maximum door height is 2.200 mm recommended.
- Minimum door height is 1.800 mm recommended.

Kod / Code No	Açıklama / Description	Renk / Colour	Birim / Unit		
118-0002-1600	CG 02 - Metal Başlı Boy Çek-Ger Mekanizması - Pull & Tension Equipments - Metal	Galvaniz / Galvanized	1 Adet / 1 Pcs	30	360

Pulltens 5

118-0005

PLASTİK BAŞLI ÇEK-GER
PULL & TENSION PLASTIC

■ 118-0005

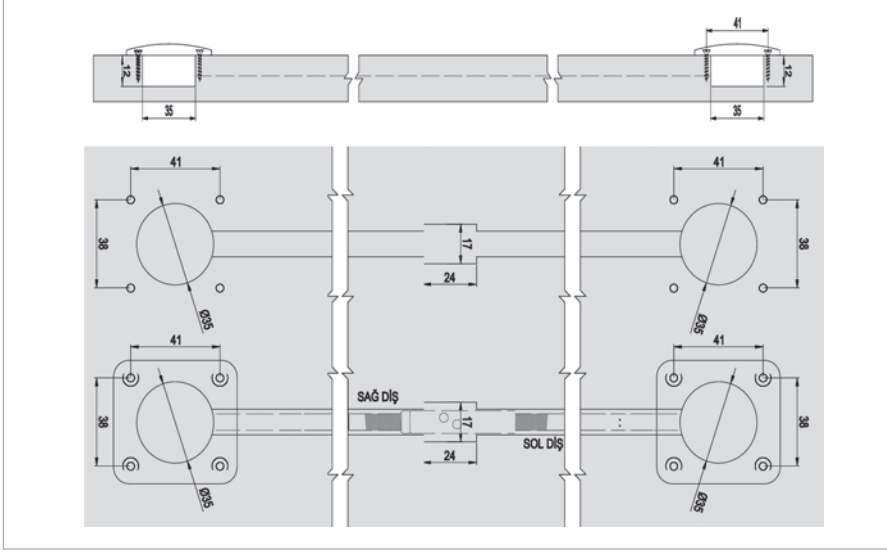

Ölçülerde değişiklik yapma hakkı saklıdır. Reserves the right to the change of the dimensions.

Bilgi / Information

- Birim adet fiyatlandırılır.
- 40 cm'den geniş kapaklarda 2 adet kullanımı önerilir.
- Özel ölçü için müşteri temsilciniz ile görüşünüz.
- Maksimum kapak yüksekliği 2.200 mm tavsiye edilir.
- Minimum kapak yüksekliği 1.700 mm tavsiye edilir.

- Unit Prices
- More than 40 cm width doors, recommended to use 2 pcs
- For special size please contact customer representative.
- Maximum door height is 2.200 mm recommended.
- Minimum door height is 1.700 mm recommended.

Kod / Code No	Açıklama / Description	Renk / Colour	Birim / Unit		
118-0005-1600	CG 05 - Plastik Başlı Çek-Ger Mekanizması - Pull & Tension Equipments - Plastic	Galvaniz / Galvanized	1 Adet / 1 Pcs	24	384

Pulltens 6

118-0006

ALÜMİNYUM ÇEK-GER
PULL & TENSION ALUMINIUM

■ 118-0006

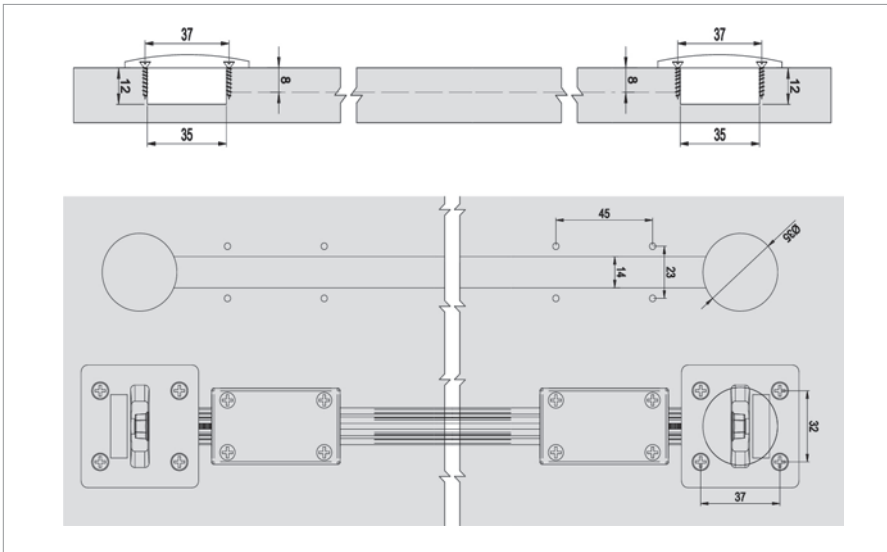
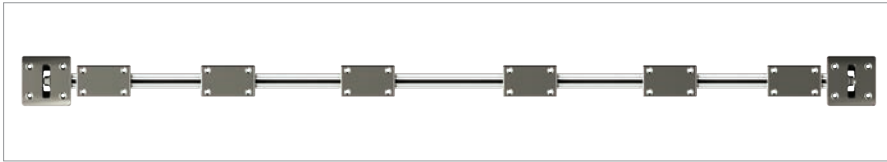

Ölçülerde değişiklik yapma hakkı saklıdır. Reserves the right to the change of the dimensions.

Bilgi / Information

- Birim adet fiyatlandırılır.
- 40 cm'den geniş kapaklarda 2 adet kullanımı önerilir.
- 3.000 mm kadar özel üretim yapılabilir.
- Maksimum kapak yüksekliği 2.300 mm tavsiye edilir.
- Minimum kapak yüksekliği 800 mm tavsiye edilir.

- Unit Prices
- More than 40 cm width doors, recommended to use 2 pcs
- Special production can be made up to 3.000 mm.
- For special size please contact customer representative.
- Maximum door height is 2.300 mm recommended.
- Minimum door height is 800 mm recommended.

Kod / Code No	Açıklama / Description	Renk / Colour	Birim / Unit		
118-0006-1400	Alüminyum Çek-Ger Mekanizması - Pull & Tension Equipments - Aluminium	Pres / Uncoated	1 Adet / 1 Pcs	30	360

Pulltens 7

118-0007

ALÜMİNYUM ZAMAK BAŞLI ÇEK-GER
ZINC PULL & TENSION ALUMINIUM

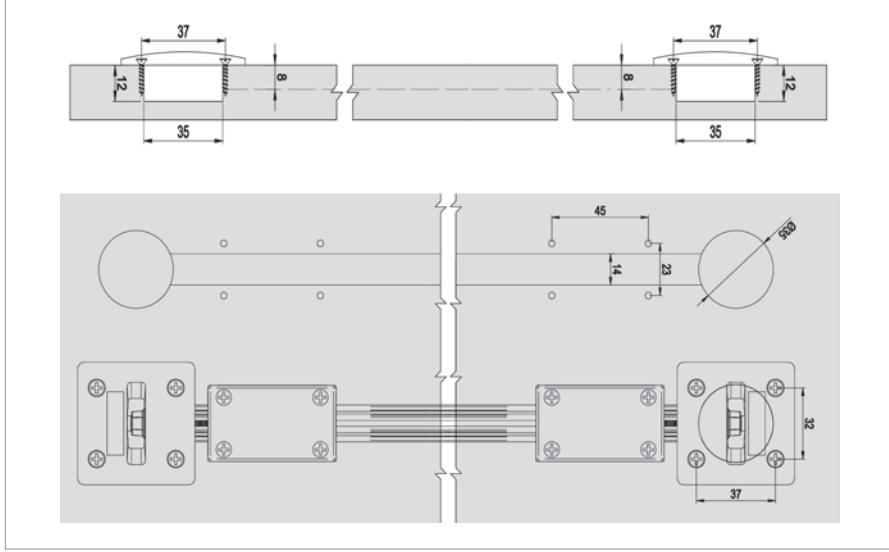
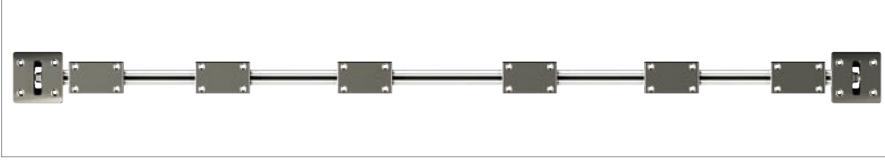

■ 118-0007



■ Bilgi / Information

- Birim adet fiyatlarıdır.
- 40 cm'den geniş kapaklarda 2 adet kullanımı önerilir.
- 3.000 mm kadar özel üretim yapılabilir.
- Maksimum kapak yüksekliği 2.300 mm tavsiye edilir.
- Minimum kapak yüksekliği 800 mm tavsiye edilir.

- Unit Prices
- More than 40 cm width doors, recommended to use 2 pcs
- Special production can be made up to 3.000 mm.
- For special size please contact customer representative.
- Maximum door height is 2.300 mm recommended.
- Minimum door height is 800 mm recommended.

Kod / Code No	Açıklama / Description	Renk / Colour	Birim / Unit		
118-0007-1400	Zamak Başlı Alüminyum Çek-Ger Mekanizması - Zinc Pull & Tension Equipment Alm.	Pres / Uncoated	1 Adet / 1 Pcs	30	360

Pulltens 9

118-0009

ALÜMİNYUM BOY ÇEK-GER
PULL & TENSION ALUMINIUM

■ 118-0009

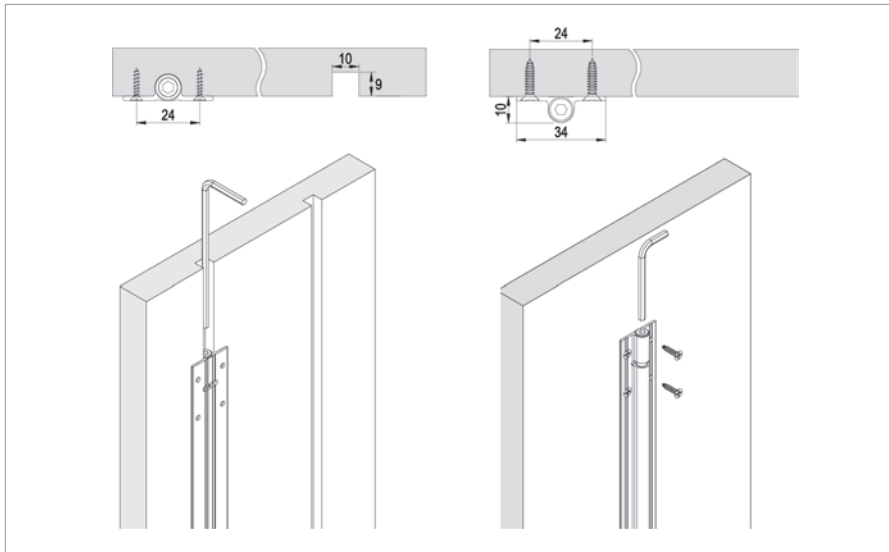
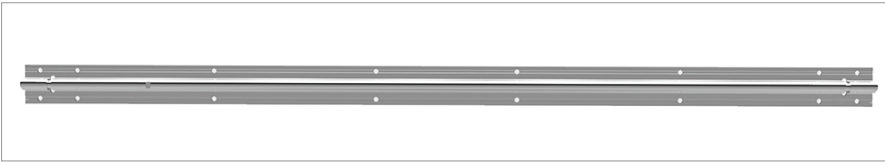

■ Bilgi / Information

- Birim adet fiyatlarıdır.
- 40 cm'den geniş kapaklarda 2 adet kullanımı önerilir.
- Minimum 1.600 - Maksimum 2.500 mm kadar özel üretim yapılabilir.
- Maksimum kapak yüksekliği 2.200 mm tavsiye edilir.
- Minimum kapak yüksekliği 2.000 mm tavsiye edilir.

- Unit Prices
- More than 40 cm width doors, recommended to use 2 pcs
- From Minimum 1.600 mm up to Maximum 2.500 mm can be made special production
- For special size please contact customer representative.
- Maximum door height is 2.200 mm recommended.
- Minimum door height is 2.000 mm recommended.

Kod / Code No	Açıklama / Description	Renk / Colour	Birim / Unit		
118-0009-1400	Alüminyum Boy Gergi Mekanizması - Aluminium Tension Mechanism	Eloksal / Mat Anodized	1 Adet / 1 Pcs	30	360

Pulltens 11

118-0011

ZAMAK BAŞLI GİZLİ ÇEK-GER
ZINC PULL & TENSION METAL

■ 118-0011

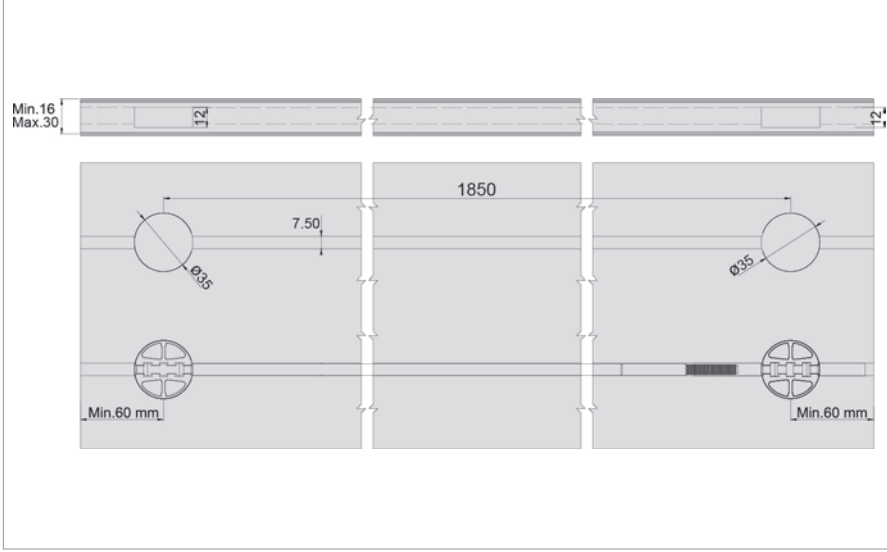



Ölçülerde değişiklik yapma hakkı saklıdır. Reserves the right to the change of the dimensions.



Bilgi / Information

- Birim adet fiyatlandırılır.
- 40 cm'den geniş kapaklarda 2 adet kullanımı önerilir.
- Özel ölçü için müşteri temsilciniz ile görüşünüz.
- Maksimum kapak yüksekliği 2.200 mm tavsiye edilir.
- Minimum kapak yüksekliği 1.950 mm tavsiye edilir.

- Unit Prices
- More than 40 cm width doors, recommended to use 2 pcs
- For special size please contact customer representative.
- Maximum door height is 2.200 mm recommended.
- Minimum door height is 1.950 mm recommended.

Kod / Code No	Açıklama / Description	Renk / Colour	Birim / Unit		
118-0011-1600	Zamak Başlı Alüminyum Çek-Ger Mekanizması - Zinc Pull & Tension Equipment Alm.	Galvaniz /Galvanized	1 Adet / 1 Pcs	30	360

Pulltens 12

118-0012

METAL ÇEK-GER
PULL & TENSION METAL

■ 118-0012

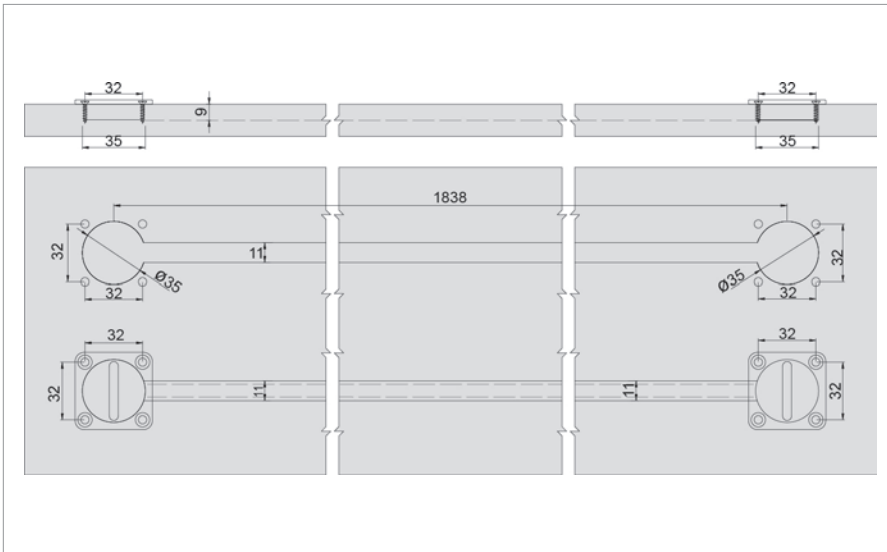



Ölçülerde değişiklik yapma hakkı saklıdır. Reserves the right to the change of the dimensions.



Bilgi / Information

- Birim adet fiyatlandırılır.
- 40 cm'den geniş kapaklarda 2 adet kullanımı önerilir.
- Özel ölçü için müşteri temsilciniz ile görüşünüz.
- Maksimum kapak yüksekliği 2.200 mm tavsiye edilir.
- Minimum kapak yüksekliği 1.950 mm tavsiye edilir.

- Unit Prices
- More than 40 cm width doors, recommended to use 2 pcs
- For special size please contact customer representative.
- Maximum door height is 2.200 mm recommended.
- Minimum door height is 1.950 mm recommended.

Kod / Code No	Açıklama / Description	Renk / Colour	Birim / Unit		
118-0012-1600	Zamak Başlı Alüminyum Çek-Ger Mekanizması - Pull & Tension Equipment Alm.	Galvaniz /Galvanized	1 Adet / 1 Pcs	30	360

Group 119

BarnDoor[®]

Üstten Askı Ahşap Sürme Kapı Serisi

Top Hanger Wooden Sliding Door Series





Bu serideki tüm ürünleri incelemek için QR kodu okutabilirsiniz.

























You can analyze the QR code to see all the products in these series.



BarnDoor 8920

<p>SINCE 1976</p>	 <p>Bearing Systems</p>	<p>EN 1527 100.000 CYCLES TEST</p> 	<p>R</p> <p>The Sliding System</p>
-----------------------	--	--	---



	OEM Kod OEM Code	Ürün Kodu Product Code	Sistem Tipi System Type	Panel Tipi Panel Type	Fren Yönü Brake Direc.	Panel mm	Taşıma Kg Capacity Kg	Video	Yavaşlatıcı Dahil Soft Closer Including
1	119-8800	BarnDoor 8800				32 - 50	60	✓	
2	119-8810	BarnDoor 8810				32 - 50	60	✓	
3	119-8820	BarnDoor 8820				32 - 50	60	✓	✓
4	119-8825	BarnDoor 8825				32 - 50	50	✓	✓
5	119-8830	BarnDoor 8830				32 - 50	80	✓	✓
6	119-8835	BarnDoor 8835				32 - 50	80	✓	✓
7	119-8900	BarnDoor 8900				8 - 12	60	✓	
8	119-8920	BarnDoor 8920				8 - 12	80	✓	✓
9	119-8925	BarnDoor 8925				8 - 12	50	✓	✓

- Verilen ölçüler bağlayıcı değildir. Önerilen kurulum ölçüleridir. Albatur ürün özelliklerinde haber vermeden değişiklik yapabilir.
- The given dimension are not binding. These are recommended asamble dimensions. Albatur can make alteration to product specification without notice.



119-8800



119-8810



119-8820



119-8825



119-8830



119-8835



119-8900



119-8920



119-8925

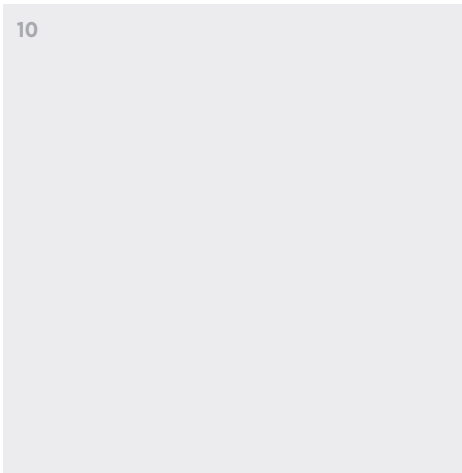

10

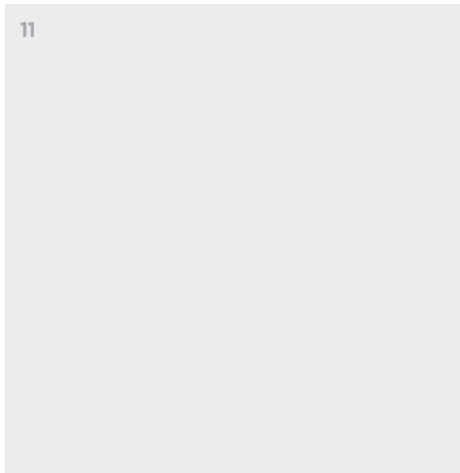

11

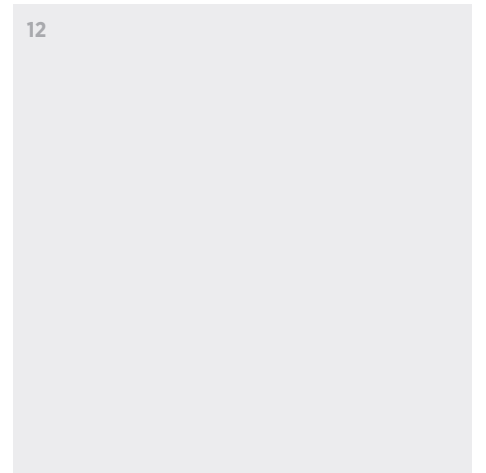

12

BarnDoor 8800

119-8800

60 KG AYARLI ÜSTTEN ASKI AĖSAP SÜRME KAPI SİSTEMİ
60 KG ADJUSTABLE TOP HANGER WOODEN SLIDING DOOR SYSTEM



Bilgi / Information

- 2.300 - 2.600 - 2.900 - 3.200 - 3.500 mm özel boylar yapılmakta olup, her bir ürün 200 mm'ye kadar kısaltma yapılabilir.
- Special sizes Can be made 2.300 - 2.600 - 2.900 - 3.200 - 3.500 mm each product can be shortened up to 200 mm.



119-8800 1 Takım İçeriği / 1 Kit Includes



Teknik Detay / Technical Detail

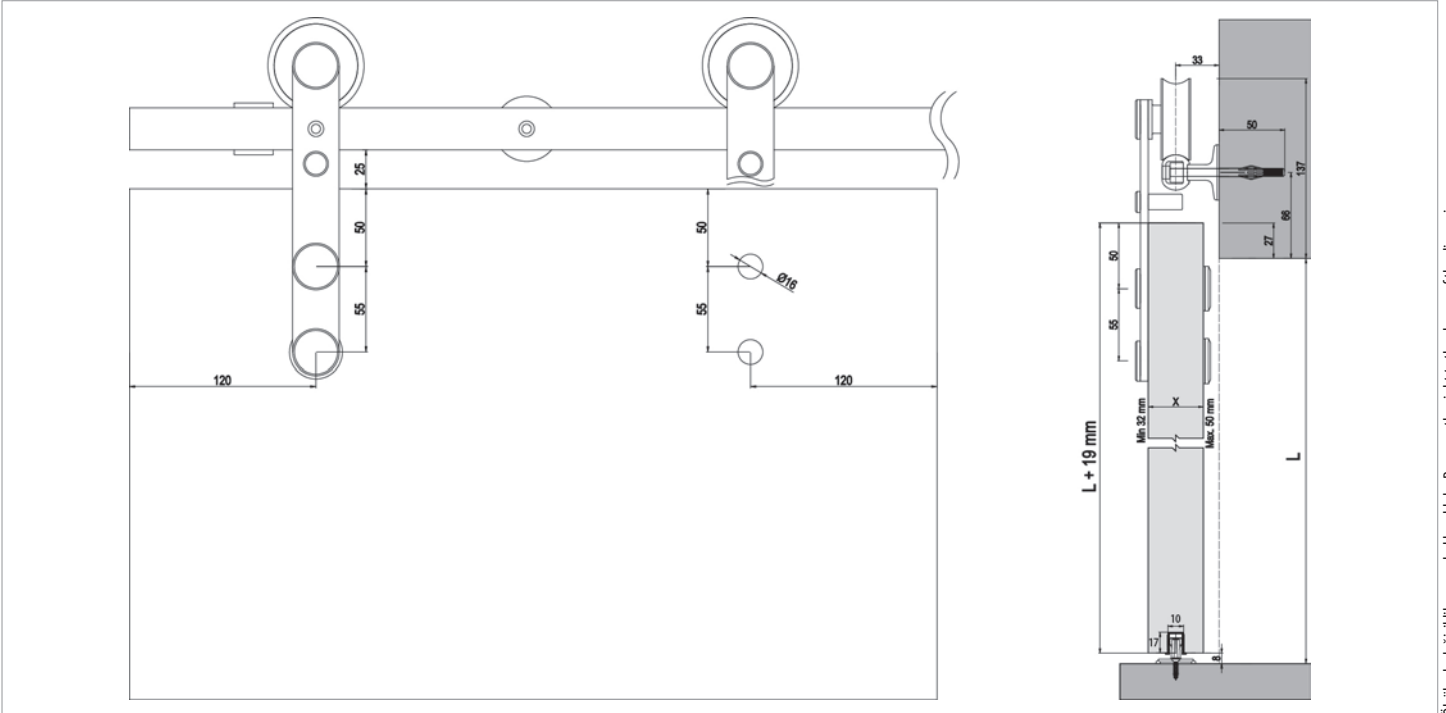

Ölçülerde değişiklik yapma hakkı saklıdır. Reserves the right to the change of the dimensions.

Uygulama / Application



SETBOX Paketleme / SETBOX Packaging



Kod / Code No	Açıklama / Description	Renk / Colour	L (mm)	Birim / Unit		
119-8800-3430-1700	60 Kg Üstten Askı Sürme Kapı Sistemi / Top Hanger Sliding System	Siyah / Black	1.700 mm	1 Kapı / 1 Kit	1	30
119-8800-3430-2000	60 Kg Üstten Askı Sürme Kapı Sistemi / Top Hanger Sliding System	Siyah / Black	2.000 mm	1 Kapı / 1 Kit	1	30

BarnDoor 8810

119-8810

60 KG AYARLI ÜSTTEN ASKI AHŞAP SÜRME KAPI SİSTEMİ
60 KG ADJUSTABLE TOP HANGER WOODEN SLIDING DOOR SYSTEM



Bilgi / Information

- 2.300 - 2.600 - 2.900 - 3.200 - 3.500 mm özel boylar yapılmakta olup, her bir ürün 200 mm'ye kadar kısaltma yapılabilir.
- Special sizes Can be made 2.300 - 2.600 - 2.900 - 3.200 - 3.500 mm each product can be shortened up to 200 mm.



119-8810 1 Takım İçeriği / 1 Kit Includes



Teknik Detay / Technical Detail

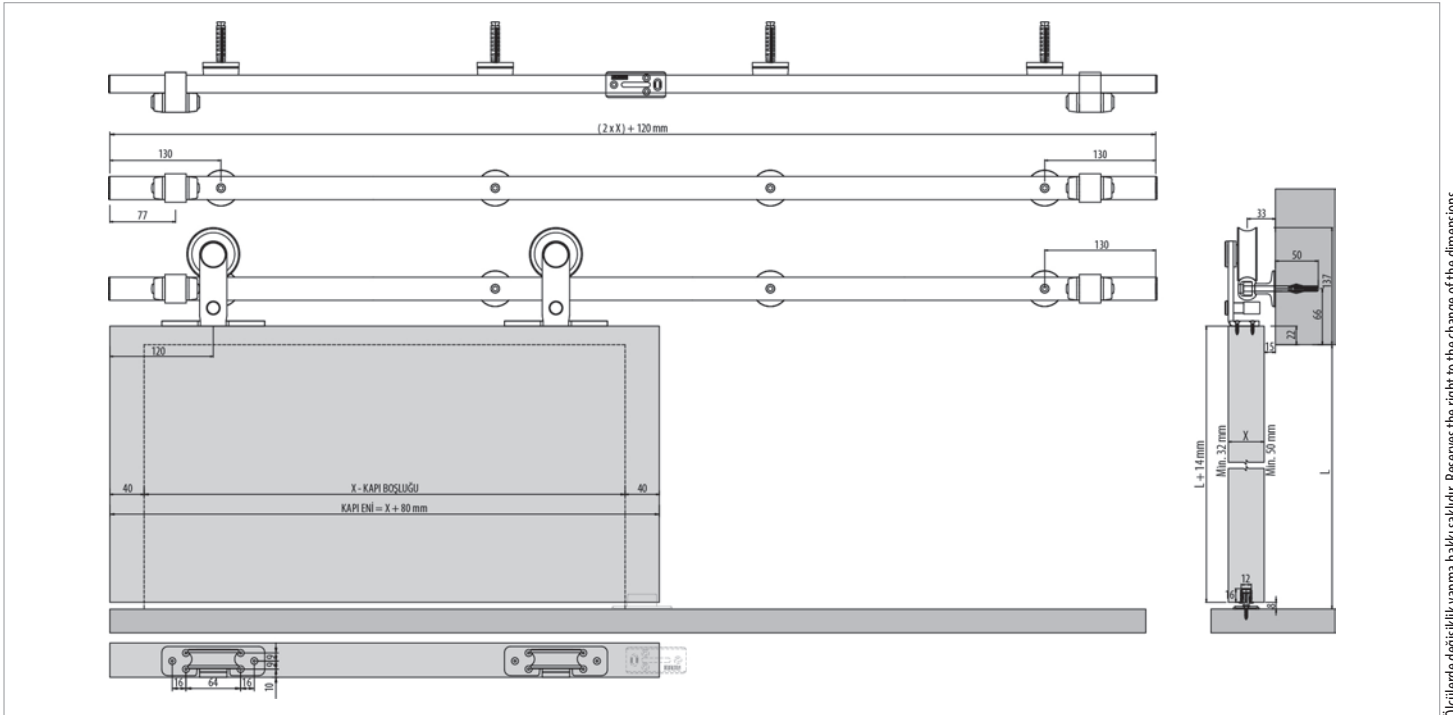

Ölçülerde değişiklik yapma hakkı saklıdır. Reserves the right to the change of the dimensions.

Uygulama / Application



SETBOX Paketleme / SETBOX Packaging



Kod / Code No	Açıklama / Description	Renk / Colour	L (mm)	Birim / Unit		
119-8810-3410-1700	60 Kg Üstten Askı Sürme Kapı Sistemi / Top Hanger Sliding System	Gri / Grey	1.700 mm	1 Kapı / 1 Kit	1	30
119-8810-3410-2000	60 Kg Üstten Askı Sürme Kapı Sistemi / Top Hanger Sliding System	Gri / Grey	2.000 mm	1 Kapı / 1 Kit	1	30

BarnDoor 8820

119-8820

80 KG AYARLI ÇİFT YÖNE YAVAŞLATICILI SÜRME KAPI SİSTEMİ

80 KG ADJUSTABLE SLIDING DOOR SYSTEM - TWO WAY SOFT CLOSING



Bilgi / Information

- 2.500 - 3.000 - 3.500 - 4.000 mm özel boylar yapılmakta olup, özel boy ürünler 500 mm'ye kadar kısaltma yapılabilir.
- Special sizes Can be made 2.500 - 3.000 - 3.500 - 4.000 mm can be shortened up to 500 mm for special sizes.

Yavaşlatıcı Alternatifi / Soft Closer Alternative

- Sistem üzerinde entegre yavaşlatıcı mevcuttur.
- There is an integrated soft close on the system.



119-8820 1 Takım İçeriği / 1 Kit Includes



Teknik Detay / Technical Detail

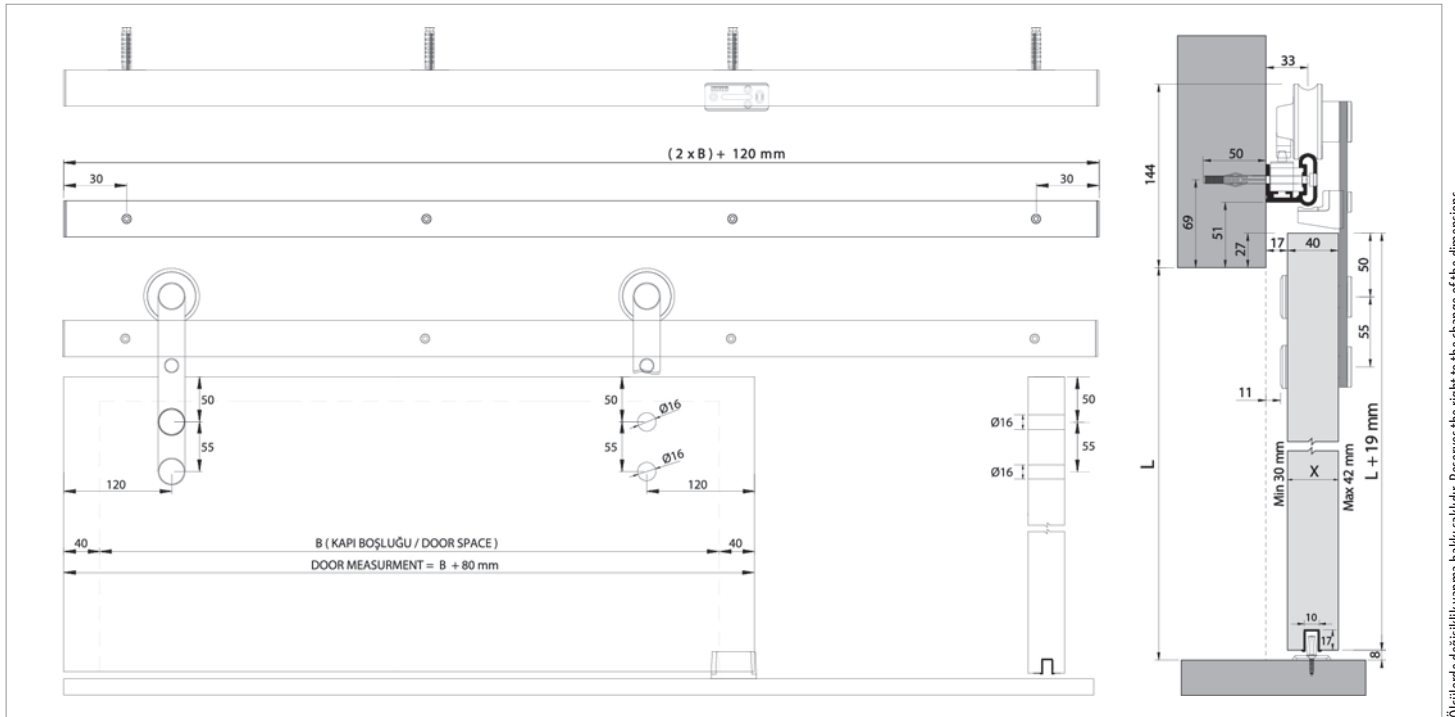

Ölçülerde değişiklik yapma hakkı saklıdır. Reserves the right to the change of the dimensions.

Uygulama / Application



SETBOX Paketleme / SETBOX Packaging



Kod / Code No	Açıklama / Description	Renk / Colour	L (mm)	Birim / Unit		
119-8820-3430-1700	80 Kg Yavaşlatıcılı Sürme Kapı Sistemi / Sliding Door Has Soft Closing System	Siyah / Black	1.700 mm	1 Kapı / 1 Kit	1	30
119-8820-3430-2000	80 Kg Yavaşlatıcılı Sürme Kapı Sistemi / Sliding Door Has Soft Closing System	Siyah / Black	2.000 mm	1 Kapı / 1 Kit	1	30

BarnDoor 8825

119-8825

50 KG AYARLI ÇİFT YÖNE YAVAŞLATICILI SÜRME KAPI SİSTEMİ
50 KG ADJUSTABLE SLIDING DOOR SYSTEM - TWO WAY SOFT CLOSING

Yeni Ürün
New Product



Bilgi / Information

- 2.500 - 3.000 - 3.500 - 4.000 mm özel boylar yapılmakta olup, özel boy ürünler 500 mm'ye kadar kısaltma yapılabilir.
- Special sizes Can be made 2.500 - 3.000 - 3.500 - 4.000 mm can be shortened up to 500 mm for special sizes.

Yavaşlatıcı Alternatifi / Soft Closer Alternative

- Sistem üzerinde entegre yavaşlatıcı mevcuttur.
- There is an integrated soft close on the system.



119-8825 1 Takım İçeriği / 1 Kit Includes



Teknik Detay / Technical Detail

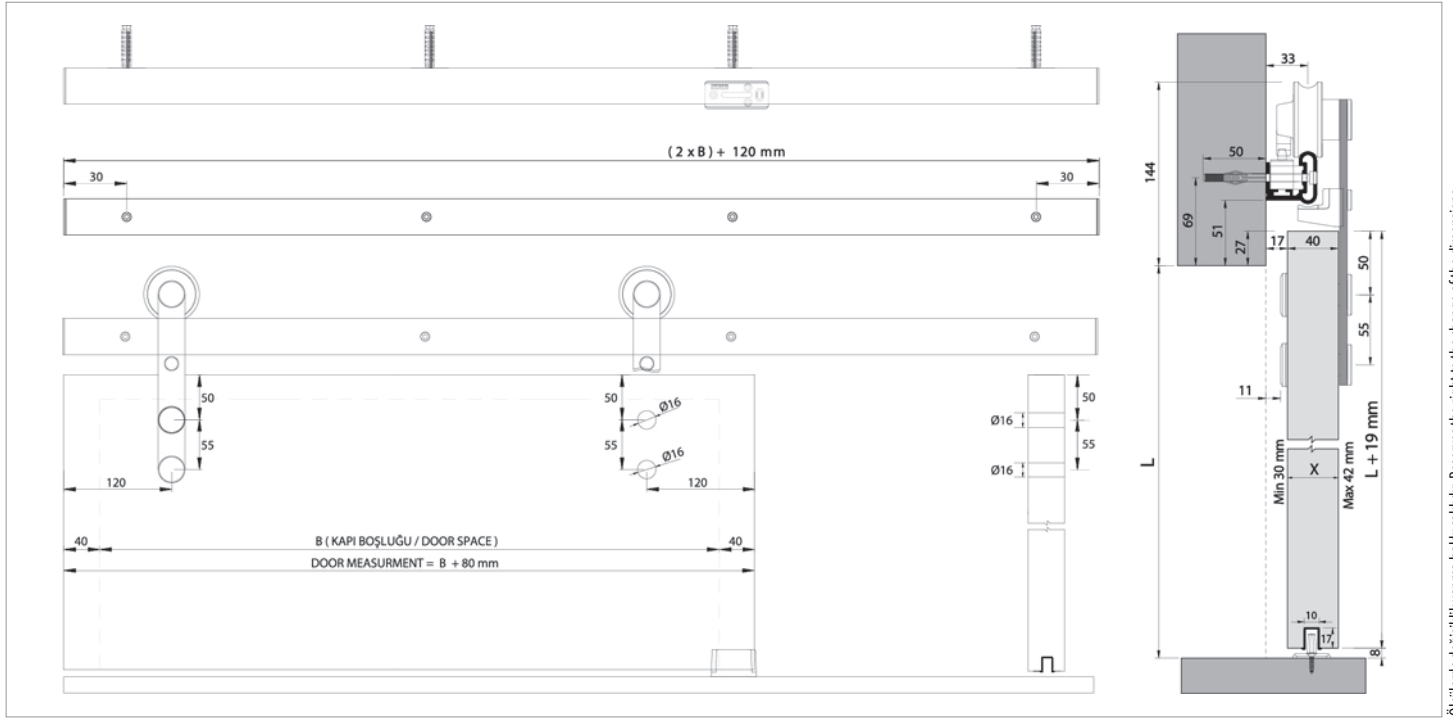

Uygulama / Application



SETBOX Paketleme / SETBOX Packaging



Kod / Code No	Açıklama / Description	Renk / Colour	L (mm)	Birim / Unit		
119-8825-3430-1700	50 Kg Yavaşlatıcı Sürme Kapı Sistemi / Sliding Door Has Soft Closing System	Siyah / Black	1.700 mm	1 Kapı / 1 Kit	1	30
119-8825-3430-2000	50 Kg Yavaşlatıcı Sürme Kapı Sistemi / Sliding Door Has Soft Closing System	Siyah / Black	2.000 mm	1 Kapı / 1 Kit	1	30

BarnDoor 8830

119-8830

80 KG AYARLI ÇİFT YÖNE YAVAŞLATICILI SÜRME KAPI SİSTEMİ
80 KG ADJUSTABLE SLIDING DOOR SYSTEM - TWO WAY SOFT CLOSING

Yeni Ürün
New Product



Bilgi / Information



















- 2.500 - 3.000 - 3.500 - 4.000 mm özel boylar yapılmakta olup, özel boy ürünler 500 mm'ye kadar kısaltma yapılabilir.
- Special sizes Can be made 2.500 - 3.000 - 3.500 - 4.000 mm can be shortened up to 500 mm for special sizes.

Yavaşlatıcı Alternatifi / Soft Closer Alternative

- Sistem üzerinde entegre yavaşlatıcı mevcuttur.
- There is an integrated soft close on the system.



119-8830 1 Takım İçeriği / 1 Kit Includes

2X  119-8820-1221-500	1X  2000 mm 119-8820-1330-550	2X  117-6995-1610-500	1X  120-9700-1600-505	4X  119-8800-1300-506	1X  120-9700-1300-508	4X  119-8820-1630-504	4X  119-8820-1820-505	4X  119-8820-1300-503
1X  119-8820-1630-501	1X  119-8820-1630-502	1X  119-8800-1300-509	1X  120-7090-1300-502	Opsiyonel / Optional  120-8005-1300	Opsiyonel / Optional  18 17 150-9170-1400	Opsiyonel / Optional  127-0102-1300-503	Opsiyonel / Optional  119-8820-1221-506	Opsiyonel / Optional  119-8820-1221-507

Teknik Detay / Technical Detail

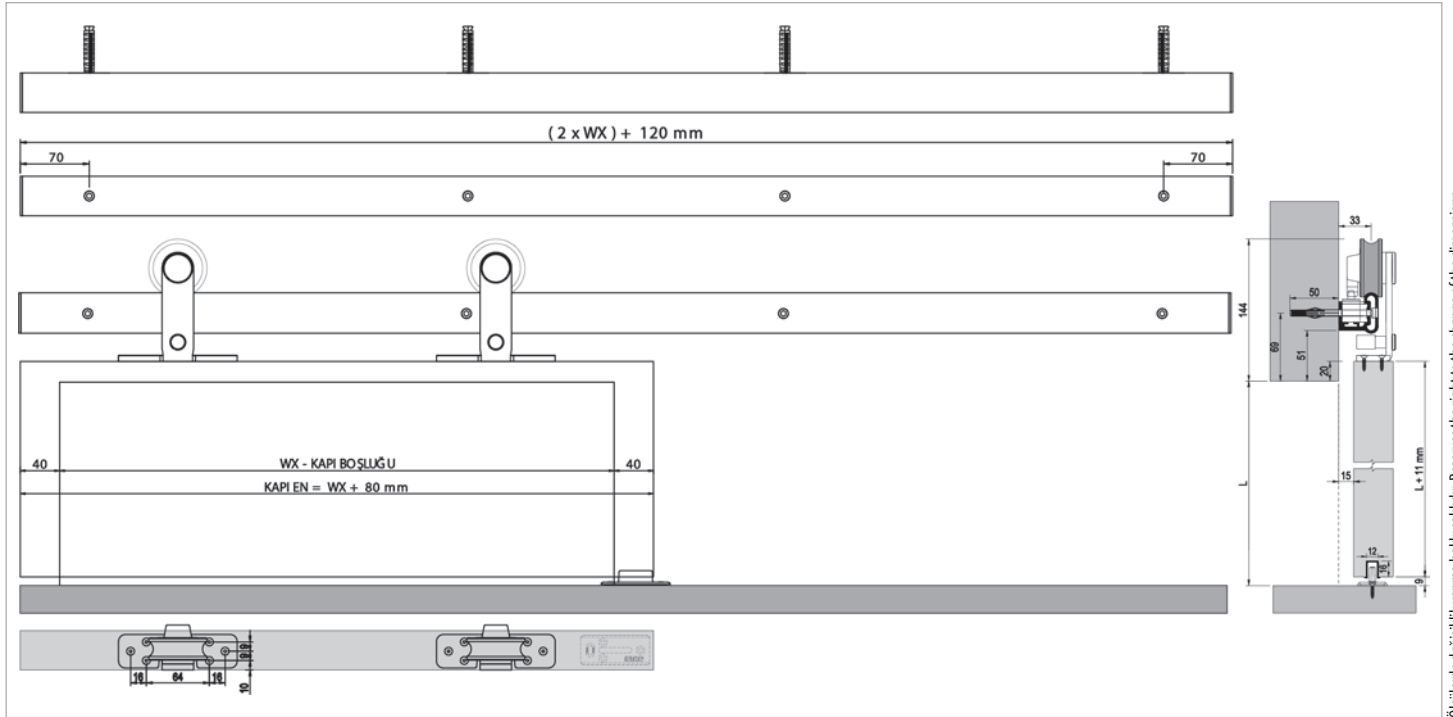



Ölçülerde değişiklik yapma hakkı saklıdır. Reserves the right to the change of the dimensions.

Uygulama / Application



SETBOX Paketleme / SETBOX Packaging



Kod / Code No	Açıklama / Description	Renk / Colour	L (mm)	Birim / Unit		
119-8830-3430-1700	80 Kg Yavaşlatıcılı Sürme Kapı Sistemi / Sliding Door Has Soft Closing System	Siyah / Black	1.700 mm	1 Kapı / 1 Kit	1	30
119-8830-3430-2000	80 Kg Yavaşlatıcılı Sürme Kapı Sistemi / Sliding Door Has Soft Closing System	Siyah / Black	2.000 mm	1 Kapı / 1 Kit	1	30

BarnDoor 8835

119-8835

50 KG AYARLI ÇİFT YÖNE YAVAŞLATICILI SÜRME KAPI SİSTEMİ
50 KG ADJUSTABLE SLIDING DOOR SYSTEM - TWO WAY SOFT CLOSING

Yeni Ürün
New Product



Bilgi / Information



















- 2.500 - 3.000 - 3.500 - 4.000 mm özel boylar yapılmakta olup, özel boy ürünler 500 mm'ye kadar kısaltma yapılabilir.
- Special sizes Can be made 2.500 - 3.000 - 3.500 - 4.000 mm can be shortened up to 500 mm for special sizes.

Yavaşlatıcı Alternatifi / Soft Closer Alternative

- Sistem üzerinde entegre yavaşlatıcı mevcuttur.
- There is an integrated soft close on the system.

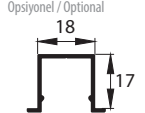

119-8835 1 Takım İçeriği / 1 Kit Includes

2X  119-8820-1221-500	1X  2000 mm 119-8820-1330-550	2X  117-6995-1610-500	1X  120-9700-1600-505	4X  119-8800-1300-506	1X  120-9700-1300-508	4X  119-8820-1630-504	4X  119-8820-1820-505	4X  119-8820-1300-503
1X  119-8820-1630-501	1X  119-8820-1630-502	1X  119-8800-1300-509	1X  120-7090-1300-502	Opsiyonel / Optional  120-8005-1300	Opsiyonel / Optional  150-9170-1400	Opsiyonel / Optional  127-0102-1300-503	Opsiyonel / Optional  119-8820-1221-506	Opsiyonel / Optional  119-8820-1221-507

Teknik Detay / Technical Detail

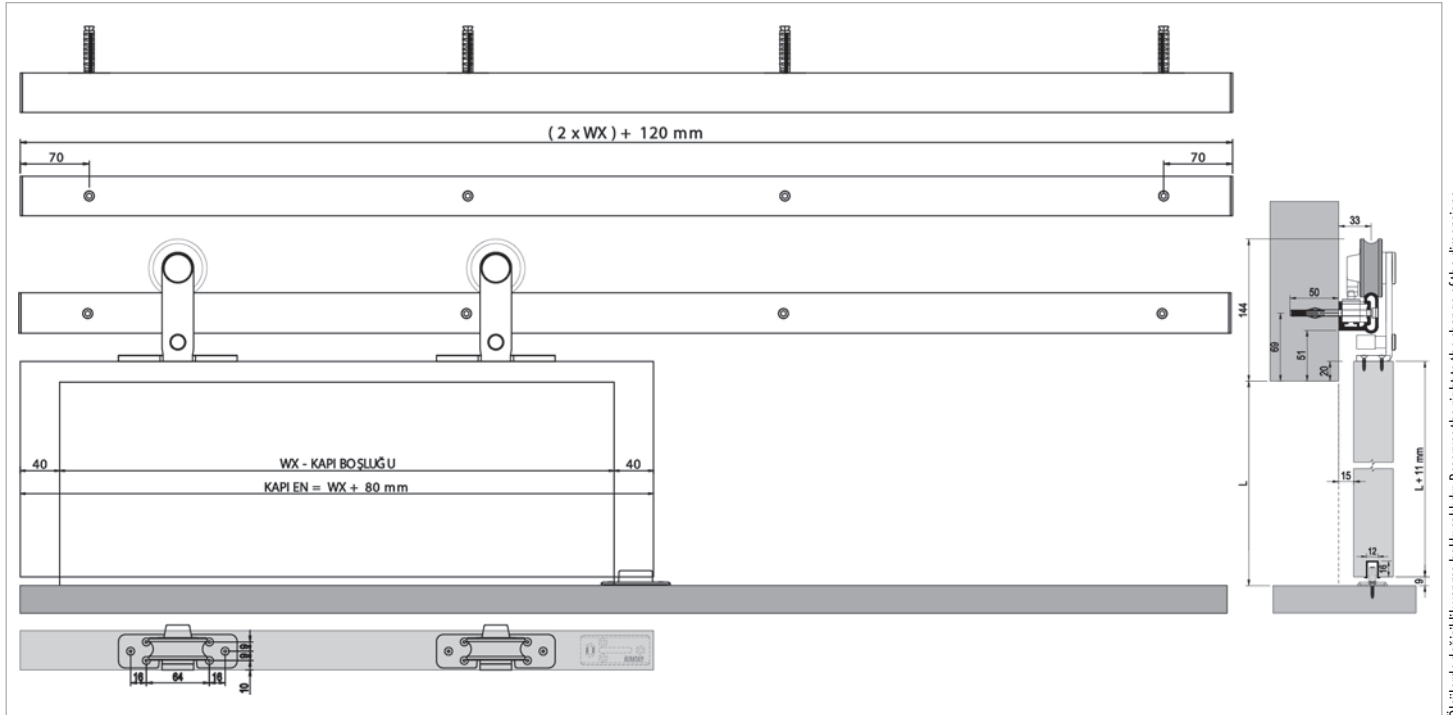



Ölçülerde değişiklik yapma hakkı saklıdır. Reserves the right to the change of the dimensions.

Uygulama / Application



SETBOX Paketleme / SETBOX Packaging



Kod / Code No	Açıklama / Description	Renk / Colour	L (mm)	Birim / Unit		
119-8835-3430-1700	50 Kg Yavaşlatıcılı Sürme Kapı Sistemi / Sliding Door Has Soft Closing System	Siyah / Black	1.700 mm	1 Kapı / 1 Kit	1	30
119-8835-3430-2000	50 Kg Yavaşlatıcılı Sürme Kapı Sistemi / Sliding Door Has Soft Closing System	Siyah / Black	2.000 mm	1 Kapı / 1 Kit	1	30



BarnDoor 8820

<p>SINCE 1976</p>	 <p>Bearing Systems</p>	<p>EN 1527 100.000 CYCLES TEST</p> 	<p>R</p> <p>The Sliding System</p>
-----------------------	--	--	---



BarnDoor 8900

119-8900

60 KG AYARLI ÜSTTEN ASKI CAM SÜRME KAPI SİSTEMİ
60 KG ADJUSTABLE TOP HANGER GLASS SLIDING DOOR SYSTEM



Bilgi / Information

- 2.300 - 2.600 - 2.900 - 3.200 - 3.500 mm özel boylar yapılmakta olup, her bir ürün 200 mm'ye kadar kısaltma yapılabilir.
- Special sizes Can be made 2.300 - 2.600 - 2.900 - 3.200 - 3.500 mm each product can be shortened up to 200 mm.



119-8900 1 Takım İçeriği / 1 Kit Includes



Teknik Detay / Technical Detail

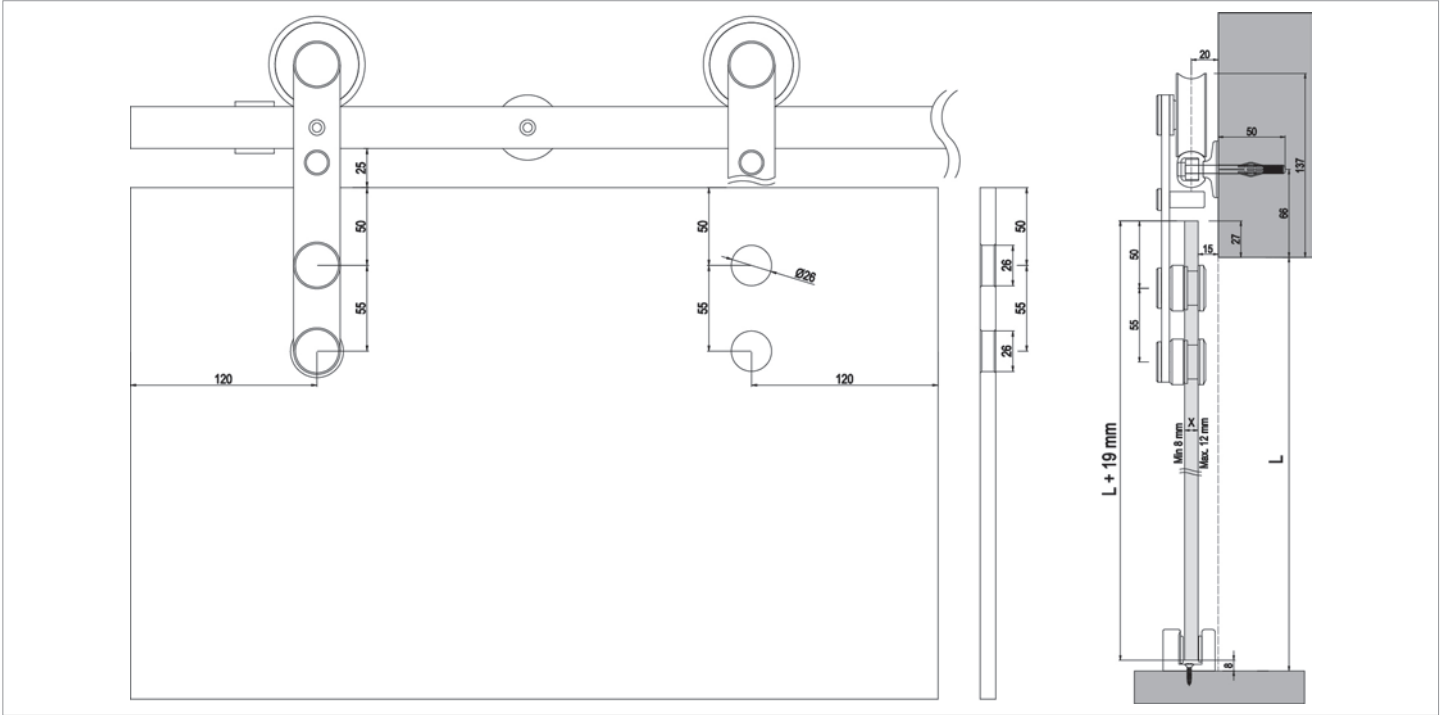

Ölçülerde değişiklik yapma hakkı saklıdır. Reserves the right to the change of the dimensions.

Uygulama / Application



SETBOX Paketleme / SETBOX Packaging



Kod / Code No	Açıklama / Description	Renk / Colour	L (mm)	Birim / Unit		
119-8900-3410-1700	60 Kg Üstten Askı Cam Sürme Kapı Sistemi / Top Hanger Glass Sliding Door System	Gri / Grey	1.700 mm	1 Kapı / 1 Kit	1	30
119-8900-3410-2000	60 Kg Üstten Askı Cam Sürme Kapı Sistemi / Top Hanger Glass Sliding Door System	Gri / Grey	2.000 mm	1 Kapı / 1 Kit	1	30

BarnDoor 8920

119-8920

80 KG AYARLI ÇİFT YÖNE YAVAŞLATICILI SÜRME CAM KAPI SİSTEMİ
80 KG ADJUSTABLE SLIDING GLASS DOOR SYSTEM - TWO WAY SOFT CLOSING



Bilgi / Information

- 2.500 - 3.000 - 3.500 - 4.000 mm özel boylar yapılmakta olup, özel boy ürünler 500 mm'ye kadar kısaltma yapılabilir.
- Special sizes Can be made 2.500 - 3.000 - 3.500 - 4.000 mm can be shortened up to 500 mm for special sizes.

Yavaşlatıcı Alternatifi / Soft Closer Alternative

- Sistem üzerinde entegre yavaşlatıcı mevcuttur.
- There is an integrated soft close on the system.



119-8920 1 Takım İçeriği / 1 Kit Includes

2X 119-8920-1221-500	1X 2000 mm 119-8820-1330-550	2X 117-6995-1610-500	1X 123-9900-1600-502	1X 123-9900-1600-505	1X 119-8800-1300-509	1X 120-7090-1300-502	4X 119-8820-1300-503	4X 119-8820-1630-504
1X 119-8820-1630-501	1X 119-8820-1630-502	1X 123-9900-1600-506	4X 119-8800-1300-506	4X 119-8920-1820-505	1X 120-9700-1300-508	Opsiyonel / Optional 119-8820-1221-506	Opsiyonel / Optional 119-8820-1221-507	

Teknik Detay / Technical Detail

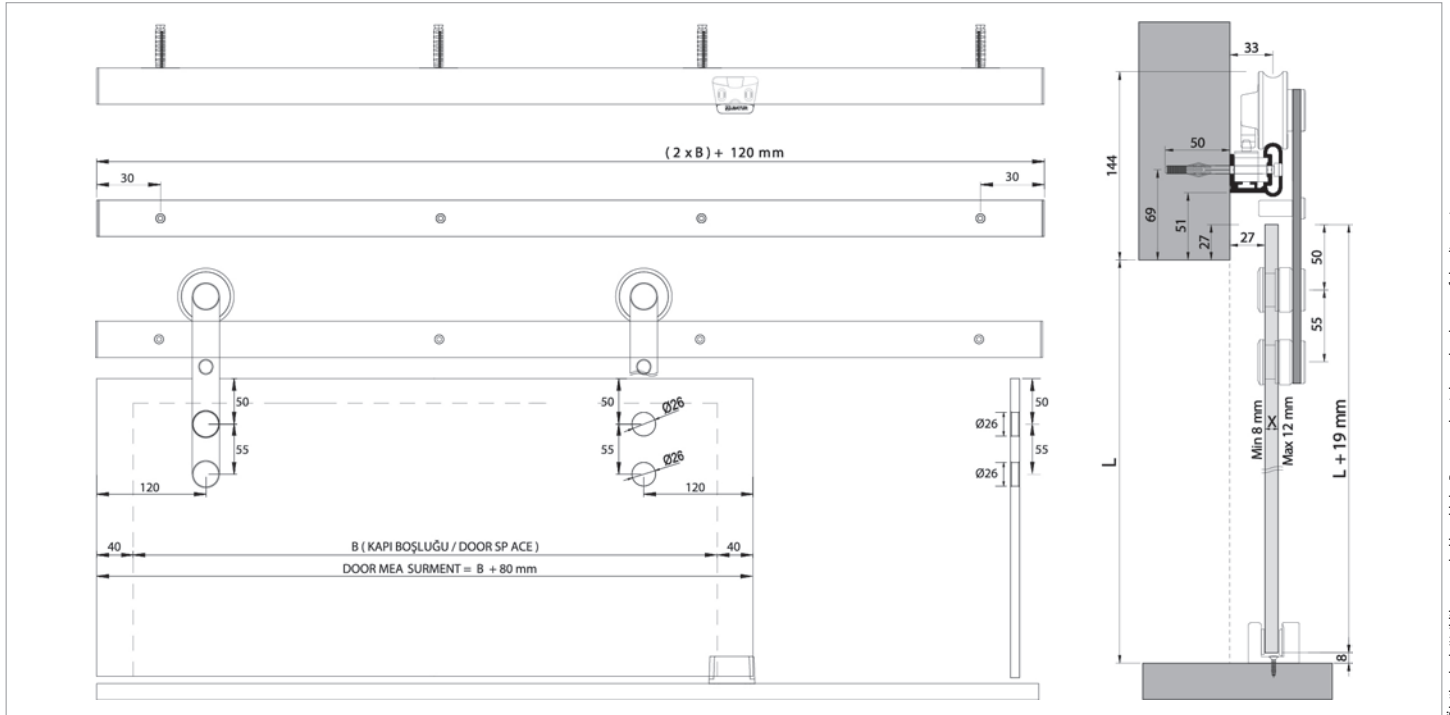

Uygulama / Application



SETBOX Paketleme / SETBOX Packaging



Kod / Code No	Açıklama / Description	Renk / Colour	L (mm)	Birim / Unit		
119-8920-3430-1700	80 Kg Yavaşlatıcılı Sürme Cam Kapı Sistemi / Glass Sliding Door System (Soft Closing)	Siyah / Black	1.700 mm	1 Kapı / 1 Kit	1	30
119-8920-3430-2000	80 Kg Yavaşlatıcılı Sürme Cam Kapı Sistemi / Glass Sliding Door System (Soft Closing)	Siyah / Black	2.000 mm	1 Kapı / 1 Kit	1	30

BarnDoor 8925

119-8925

50 KG AYARLI ÇİFT YÖNE YAVAŞLATICILI SÜRME CAM KAPI SİSTEMİ
50 KG ADJUSTABLE SLIDING GLASS DOOR SYSTEM - TWO WAY SOFT CLOSING

Yeni Ürün
New Product



Bilgi / Information

- 2.500 - 3.000 - 3.500 - 4.000 mm özel boylar yapılmakta olup, özel boy ürünler 500 mm'ye kadar kısaltma yapılabilir.
- Special sizes Can be made 2.500 - 3.000 - 3.500 - 4.000 mm can be shortened up to 500 mm for special sizes.

Yavaşlatıcı Alternatifi / Soft Closer Alternative

- Sistem üzerinde entegre yavaşlatıcı mevcuttur.
- There is an integrated soft close on the system.



119-8925 1 Takım İçeriği / 1 Kit Includes

2X 119-8920-1221-500	1X 2000 mm 119-8820-1330-550	2X 117-6995-1610-500	1X 123-9900-1600-502	1X 123-9900-1600-505	1X 119-8800-1300-509	1X 120-7090-1300-502	4X 119-8820-1300-503	4X 119-8820-1630-504
1X 119-8820-1630-501	1X 119-8820-1630-502	1X 123-9900-1600-506	4X 119-8800-1300-506	4X 119-8920-1820-505	1X 120-9700-1300-508	Opsiyonel / Optional 119-8820-1221-506	Opsiyonel / Optional 119-8820-1221-507	

Teknik Detay / Technical Detail

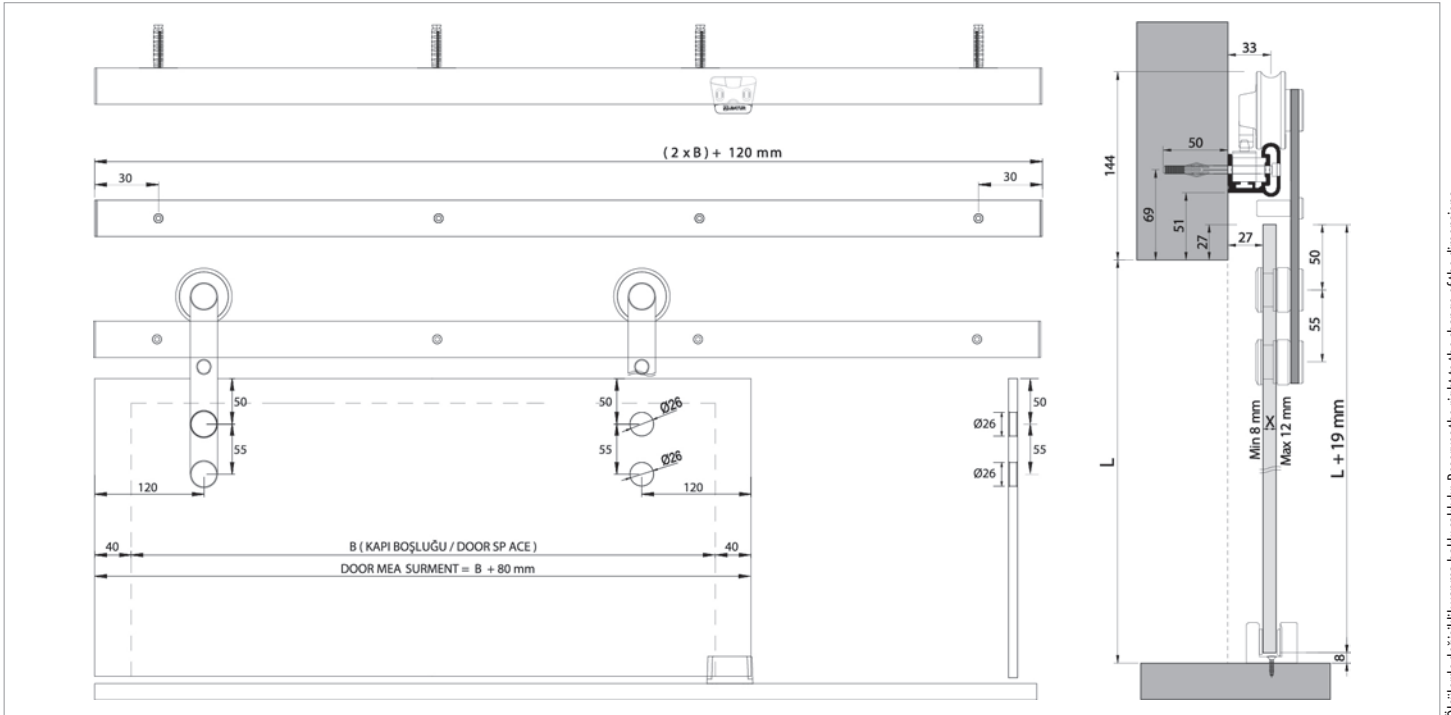



Uygulama / Application



SETBOX Paketleme / SETBOX Packaging



Kod / Code No	Açıklama / Description	Renk / Colour	L (mm)	Birim / Unit		
119-8925-3430-1700	50 Kg Yavaşlatıcılı Sürme Cam Kapı Sistemi / Glass Sliding Door System (Soft Closing)	Siyah / Black	1.700 mm	1 Kapı / 1 Kit	1	30
119-8925-3430-2000	50 Kg Yavaşlatıcılı Sürme Cam Kapı Sistemi / Glass Sliding Door System (Soft Closing)	Siyah / Black	2.000 mm	1 Kapı / 1 Kit	1	30

Group 120

DoorSlide[®]

Ahşap Sürme Kapı Serisi
Wooden Sliding Door Series



Bu serideki tüm ürünleri incelemek için
QR kodu okutabilirsiniz.

You can analyze the QR code to see all the
products in these series.



120-1000



120-9010



120-9015



120-9012



120-9020



120-9701

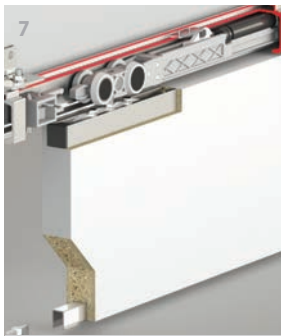

120-9706



120-9720



120-9725



120-7090



120-7099



120-7310



120-7340



120-7380

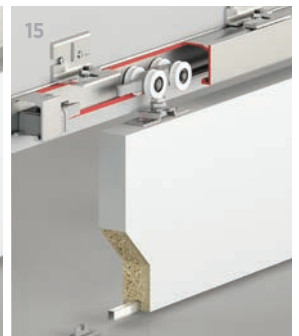

120-9600

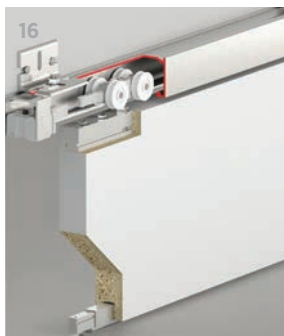

120-9100

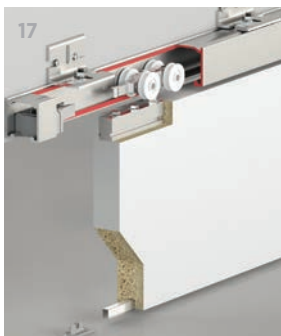

120-9200

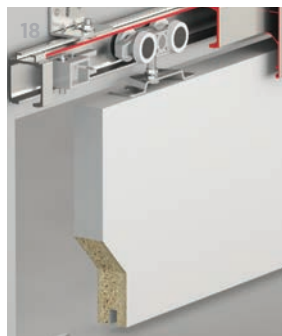

120-9700



120-9705



120-7120

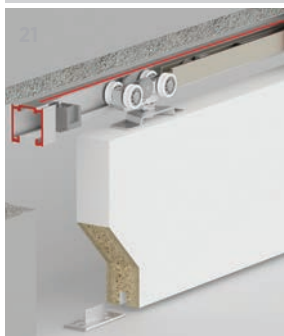

120-9080



120-9085

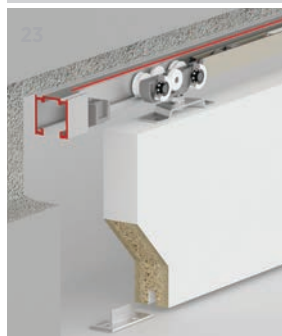







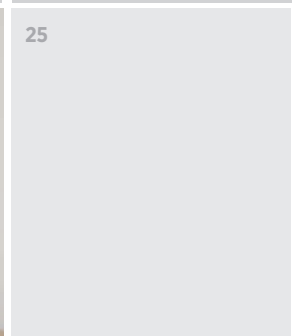



























































120-9090



120-8000





25

	OEM Kod OEM Code	Ürün Kodu Product Code	Sistem Tipi System Type	Panel Tipi Panel Type	Fren Yönü Brake Direc.	Panel mm	Taşıma Kg Capacity Kg	Video	Üst Ray Upper Rail	Alt Ray Lower Rail	Kapak Adeti Number of Doors	Yavaşlatıcı Dahil Soft Closer Including	Min. Kapı Genişlik mm Min. Door Width mm
1	120-1000	DoorSlide 1000				35 - 50	80	✓	-	-	1		-
2	120-8000	DoorSlide 8000				40-50	40		-	-	1	✓	-
3	120-9010	DoorSlide 9010				30 - 60	60	✓	150-9775	150-9762	1	✓	650 mm
4	120-9015	DoorSlide 9015				30 - 60	60	✓	150-9775	150-9762	1	✓	650 mm
5	120-9012	DoorSlide 9012				25 - 60	60	✓	150-9775	150-9762	1	✓	650 mm
6	120-9020	DoorSlide 9020				25 - 60	40	✓	150-9775	150-9762	1	✓	450 mm
7	120-9080	DoorSlide 9080				25-60	120	✓	150-9780	150-9162	1	✓	650 mm
8	120-9885	DoorSlide 9085				30-60	120	✓	150-9780	150-9162	1	✓	650 mm
9	120-9090	DoorSlide 9090				25-60	120	✓	150-9780	150-9162	1	✓	610 mm
10	120-9701	DoorSlide 9701				20 - 60	120	✓	150-9750	150-9162	1	✓	500 mm
11	120-9706	DoorSlide 9706				30 - 60	120		150-9750	150-9162	1	✓	500 mm
12	120-9720	DoorSlide 9720				20 - 60	120	✓	150-9750	150-9162	1	✓	830 mm
13	120-9725	DoorSlide 9725				30 - 60	120	✓	150-9750	150-9162	1	✓	830 mm
14	120-7090	DoorSlide 7090				18 - 50	80	✓	150-7091	150-9162	1		-
15	120-7099	DoorSlide 7099				18 - 50	80	✓	150-7091	150-9162	1		-
16	120-7310	DoorSlide 7310				18 - 50	51	✓	150-7122	150-9162	1		-
17	120-7340	DoorSlide 7340				18 - 50	60		150-7122	150-9162	1		-
18	120-7380	DoorSlide 7380				18 - 50	80	✓	150-7244	150-9162	1		-
19	120-9600	DoorSlide 9600				18 - 50	160		150-9150	150-9162	1		-
20	120-9100	DoorSlide 9100				40 - 50	250	✓	150-9150	150-9460	1		-
21	120-9200	DoorSlide 9200				40 - 50	250	✓	150-9150	150-9162	1		-
22	120-9700	DoorSlide 9700				20 - 60	120	✓	150-9750	150-9162	1		-
23	120-9705	DoorSlide 9705				30 - 60	120	✓	150-9750	150-9162	1		-
24	120-7120	DoorSlide 7120				25 - 50	120	✓	150-7093	150-9162	1		-

• Verilen ölçüler bağlayıcı değildir. Önerilen kurulum ölçüleridir. Albatur ürün özelliklerinde haber vermeden değişiklik yapabilir.
• The given dimension are not binding. These are recommended assemble dimensions. Albatur can make alteration to product specification without notice.



DoorSlide 9010

SINCE 1976	 Bearing Systems	EN 1527 100.000 CYCLES TEST 	 The Sliding System
---------------	---	---	---



DoorSlide 1000

120-1000

80 KG AYARLI COPLANAR SÜRME KAPI SİSTEMİ
80 KG ADJUSTABLE COPLANAR SLIDING DOOR SYSTEM

Yeni Ürün
New Product



Bilgi / Information

- Kapı genişliği minimum 400 mm maksimum 1.500 mm olmalıdır.
• Door width min. 400 mm max. 1.500 mm
- Maksimum kapı yüksekliği 2.800 mm olmalıdır.
• Max. door height 2.800 mm



120-1000 1 Takım İçeriği / 1 Kit Includes



Uygulama / Application

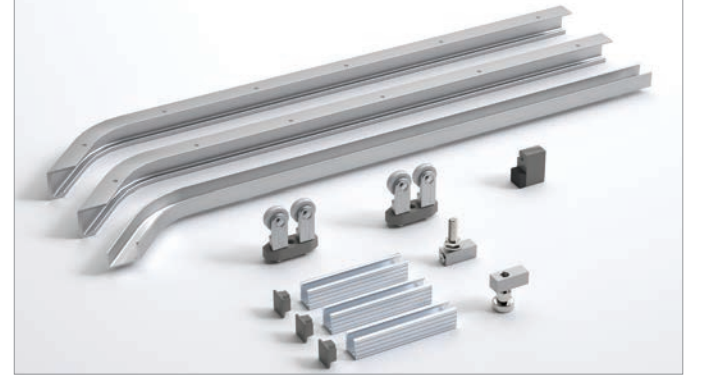

Teknik Detay / Technical Detail

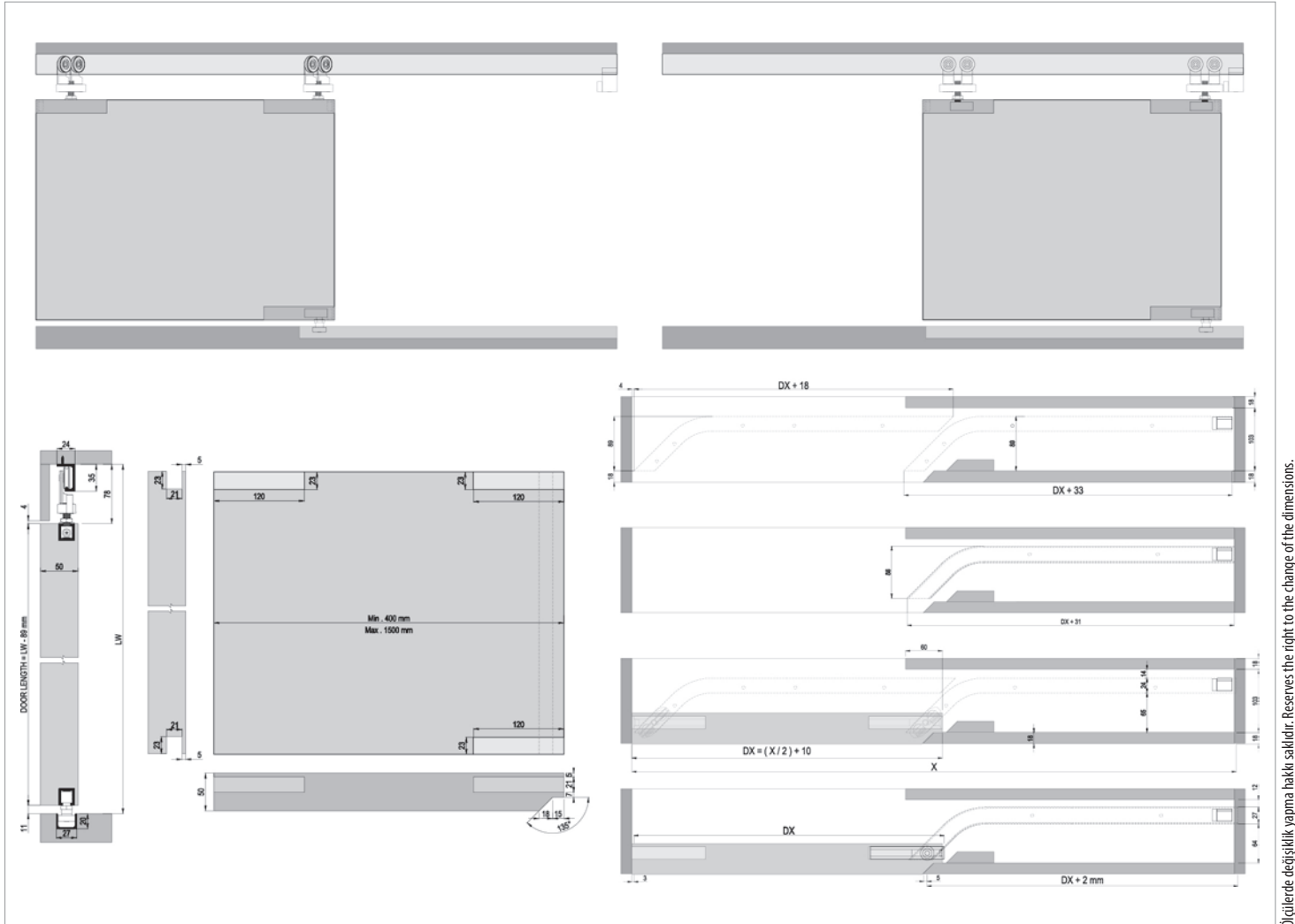



Ölçülerde değişiklik yapma hakkı saklıdır. Reserves the right to the change of the dimensions.

Kod / Code No	Açıklama / Description	Renk / Colour	Birim / Unit		
120-1000-3410-1500	80 Kg Coplanar Sürme Kapı Sistemi / Coplanar Sliding Door System	Bronz / Bronze	1 Kapı / 1 Kit	1	50





DoorSlide 1000

<p>SINCE 1976</p>	 <p>Bearing Systems</p>	<p>EN 1527 100.000 CYCLES TEST</p> 	<p>R</p> <p>The Sliding System</p>
-----------------------	---	--	---





DoorSlide 8000

SINCE 1976	 Bearing Systems	EN 1527 100.000 CYCLES TEST 	 The Sliding System
---------------	---	---	---



DoorSlide 8000

120-8000

40 KG AYARLI ÇİFT YÖNE YAVAŞLATICILI SÜRME KAPI SİSTEMİ
40 KG ADJUSTABLE SLIDING DOOR SYSTEM - TWO WAY SOFT CLOSING

Yeni Ürün
New Product



Bilgi / Information

- Minimum kapı eni 600 mm olmalıdır.
- The minimum door width should be 600 mm.



120-8000 1 Takım İçeriği / 1 Kit Includes

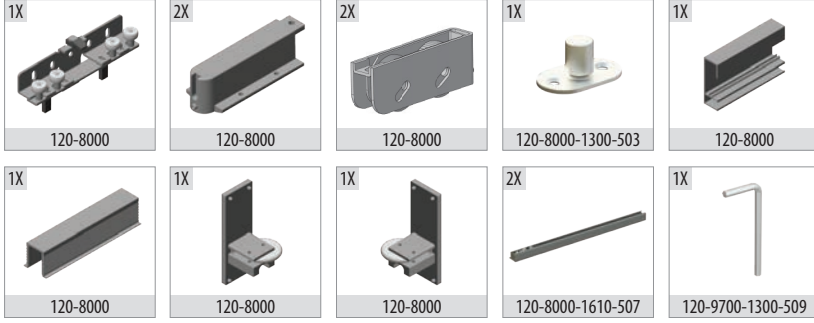

Kod / Code No	Açıklama / Description	Renk / Colour	Birim / Unit		
120-8000-3410-2000	40 Kg Softline Sürme Kapı Sistemi • Softline Sliding Door System	Eloksal / Mat Anodized	1 Kapı / 1 Kit	1	30

DoorSlide 9010

120-9010

60 KG AYARLI ÇİFT YÖNE YAVAŞLATICILI SÜRME KAPI SİSTEMİ

60 KG ADJUSTABLE SLIDING DOOR SYSTEM - TWO WAY SOFT CLOSING



Bilgi / Information

- Minimum kapı genişliği 650 mm olmalıdır.
- Min. Door width 650 mm

Yavaşlatıcı Alternatifi / Soft Closer Alternative

- Sistem üzerinde çift yöne yavaşlatıcı mevcuttur.
- The system has two way soft closing.



120-9010 1 Takım İçeriği / 1 Kit Includes



Ray Profilleri / Rail Profiles

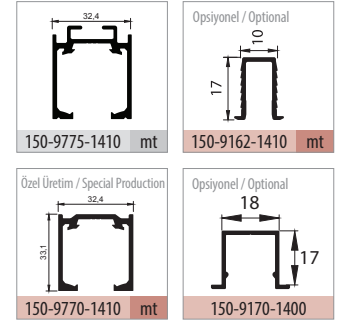

Teknik Detay / Technical Detail

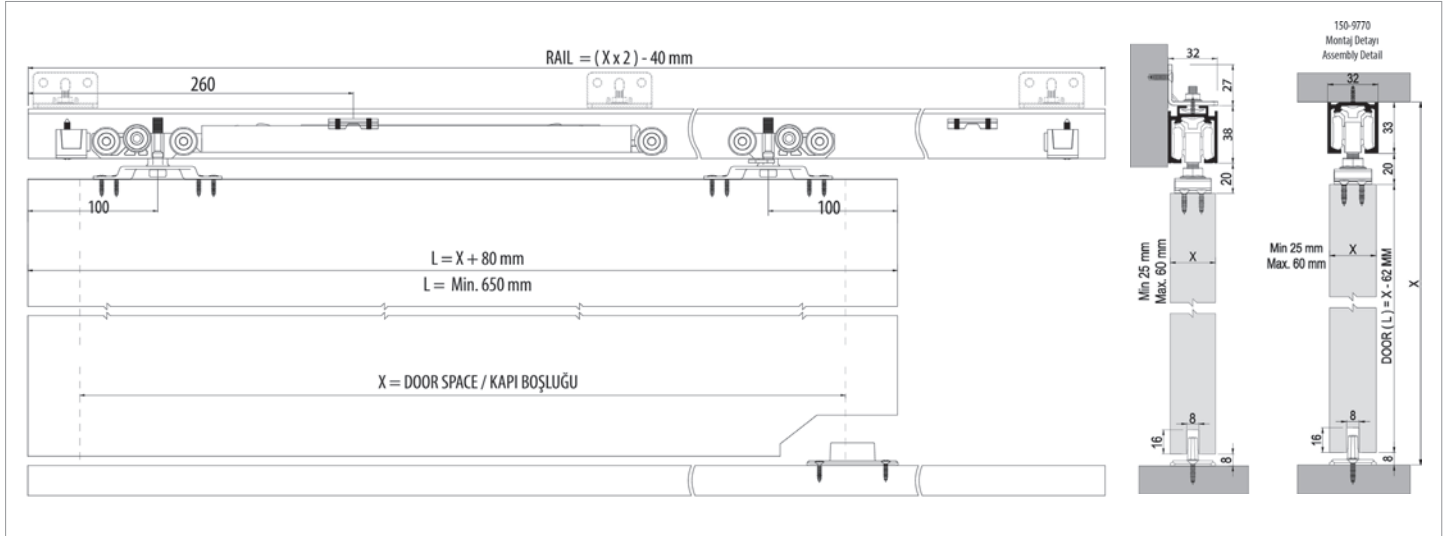

Ölçülerde değişiklik yapma hakkı saklıdır. Reserves the right to the change of the dimensions.

Uygulama / Application



* Duvar içi uygulamalarda, mekanizmanın hareketli teker bloğu sayesinde ray içi montajını kolaylaştırmaktadır.

* In wall-mounted applications, the mechanism's movable wheel block facilitates installation within the rail.

Kod / Code No	Açıklama / Description	Renk / Colour	Birim / Unit			Profil mt. / Profiles mt.	Bağ / Bnd.
120-9010-1410	9010 SFT - 60 Kg Yavaş Sürme Kapı Sistemi / Sliding Door System - Soft Closing	Gri / Grey	1 Kapı / 1 Kit	12	576	-	-
150-9775-1410	Alüminyum Üst Ray Profili / Aluminium Top Rail Profile	Eloksal / Mat Anodized	mt.	-	-	2,0	3,0
150-9162-1410	Alüminyum Alt Klavuz Profili / Aluminium Bottom Slider Profile	Eloksal / Mat Anodized	mt.	-	-	-	3,0

DoorSlide 9015

120-9015

60 KG AYARLI ÇİFT YÖNE YAVAŞLATICILI SÜRME KAPI SİSTEMİ

60 KG ADJUSTABLE SLIDING DOOR SYSTEM - TWO WAY SOFT CLOSING



Bilgi / Information

- Minimum kapı genişliği 650 mm olmalıdır.
- Min. Door width 650 mm

Yavaşlatıcı Alternatifi / Soft Closer Alternative

- Sistem üzerinde çift yöne yavaşlatıcı mevcuttur.
- The system has two way soft closing.



120-9015 1 Takım İçeriği / 1 Kit Includes



Ray Profilleri / Rail Profiles

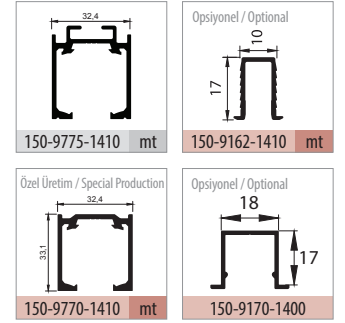

Teknik Detay / Technical Detail

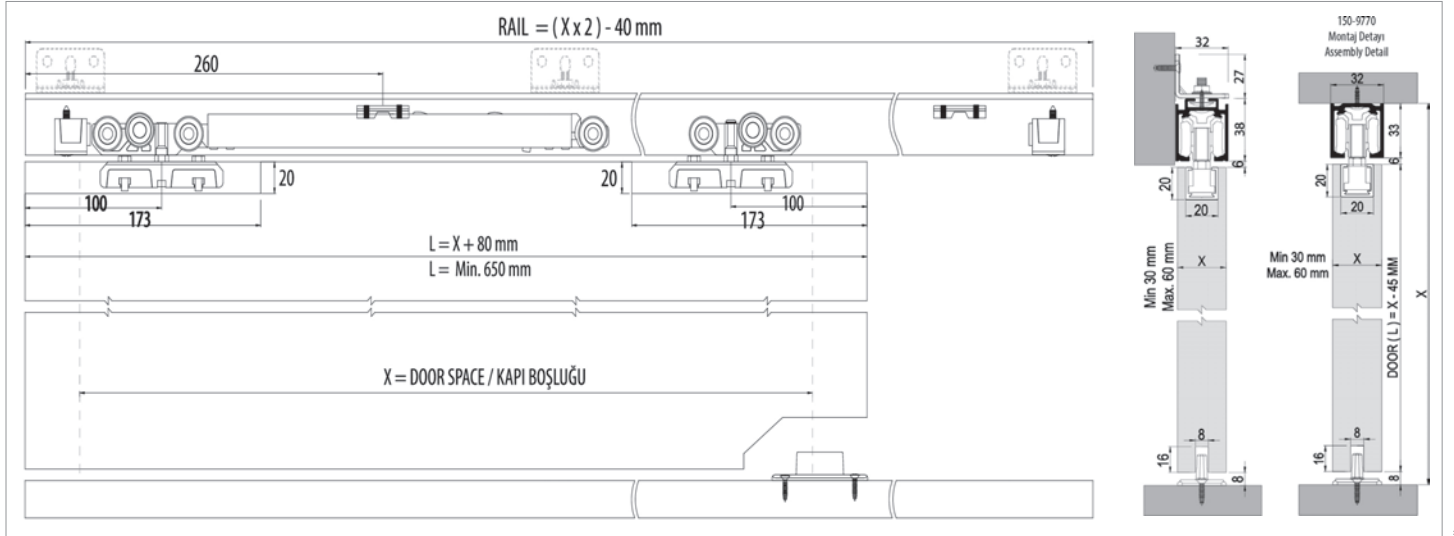

Uygulama / Application



* Duvar içi uygulamalarda, mekanizmanın hareketli teker bloğu sayesinde ray içi montajını kolaylaştırmaktadır.

* In wall-mounted applications, the mechanism's movable wheel block facilitates installation within the rail.

Kod / Code No	Açıklama / Description	Renk / Colour	Birim / Unit			Profil mt. / Profiles mt.	Bağ / Bnd.
120-9015-1410	60 Kg Yavaşlatıcı Sürme Kapı Sistemi / Sliding Door System - Two Way Soft Closing	Gri / Grey	1 Kapı / 1 Kit	12	360	-	-
150-9775-1410	Alüminyum Üst Ray Profili / Aluminium Top Rail Profile	Eloksal / Mat Anodized	mt.	-	-	2,0	3,0
150-9162-1410	Alüminyum Alt Klavuz Profili / Aluminium Bottom Slider Profile	Eloksal / Mat Anodized	mt.	-	-	-	3,0

DoorSlide 9012

120-9012

60 KG AYARLI ÇİFT YÖNE YAVAŞLATICILI SÜRME KAPI SİSTEMİ
60 KG ADJUSTABLE SLIDING DOOR SYSTEM - TWO WAY SOFT CLOSING

Özel Üretim
Special Production



Bilgi / Information

- Minimum kapı genişliği 610 mm olmalıdır.
- Min. Door width 610 mm

Yavaşlatıcı Alternatifi / Soft Closer Alternative

- Sistem üzerinde çift yöne yavaşlatıcı mevcuttur.
- The system has two way soft closing.



120-9012 1 Takım İçeriği / 1 Kit Includes

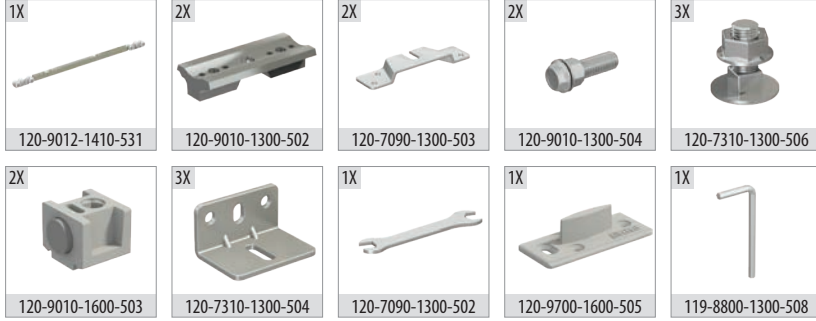

Ray Profilleri / Rail Profiles

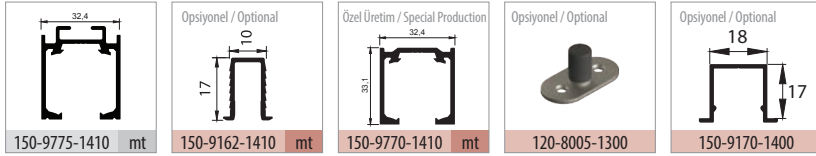

Uygulama / Application



* Duvar içi uygulamalarda, mekanizmanın hareketli teker bloğu sayesinde ray içi montajını kolaylaştırmaktadır.

* In wall-mounted applications, the mechanism's movable wheel block facilitates installation within the rail.

Teknik Detay / Technical Detail

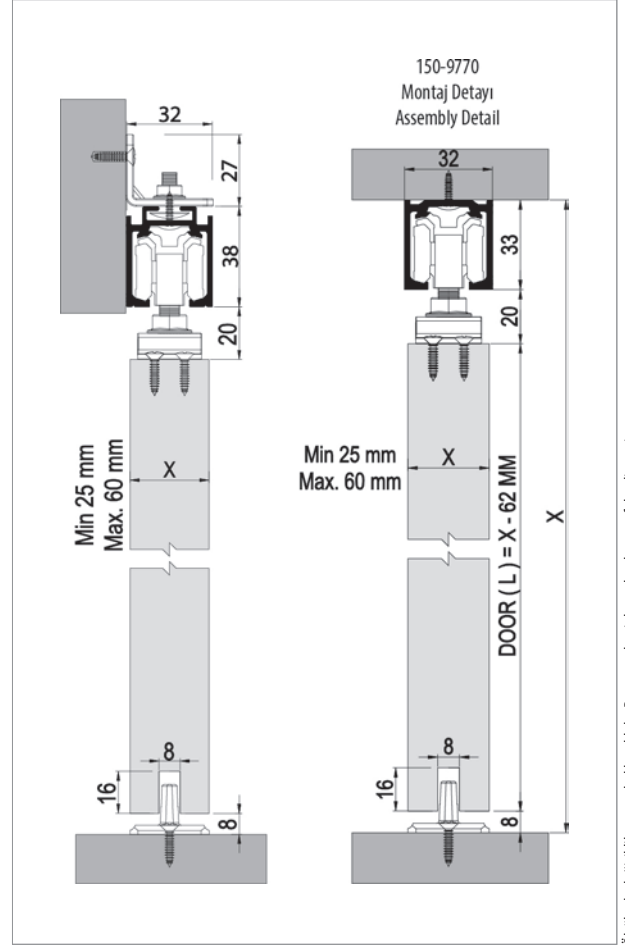

Ölçülerde değişiklik yapma hakkı saklıdır. Reserves the right to the change of the dimensions.

Kod / Code No	Açıklama / Description	Renk / Colour	Birim / Unit			Profil mt. / Profiles mt.	Bağ / Bnd.
120-9012-1410	60 Kg Yavaş. Sürme Kapı Sistemi / Sliding Door System - Two Way Soft Closing	Gri / Grey	1 Kapı / 1 Kit	12	360	-	-
150-9775-1410	Alüminyum Üst Ray Profili / Aluminium Top Rail Profile	Eloksal / Mat Anodized	mt.	-	-	2,0	3,0
150-9162-1410	Alüminyum Alt Klavuz Profili / Aluminium Bottom Slider Profile	Eloksal / Mat Anodized	mt.	-	-	-	3,0

DoorSlide 9020

120-9020

40 KG AYARLI ÇİFT YÖNE YAVAŞLATICILI SÜRME KAPI SİSTEMİ
40 KG ADJUSTABLE SLIDING DOOR SYSTEM - TWO WAY SOFT CLOSING

Özel Üretim
Special Production



Bilgi / Information

- Minimum kapı genişliği 450 mm olmalıdır.
- Min. Door width 450 mm

Yavaşlatıcı Alternatifi / Soft Closer Alternative

- Sistem üzerinde çift yöne yavaşlatıcı mevcuttur.
- The system has two way soft closing.



120-9020 1 Takım İçeriği / 1 Kit Includes

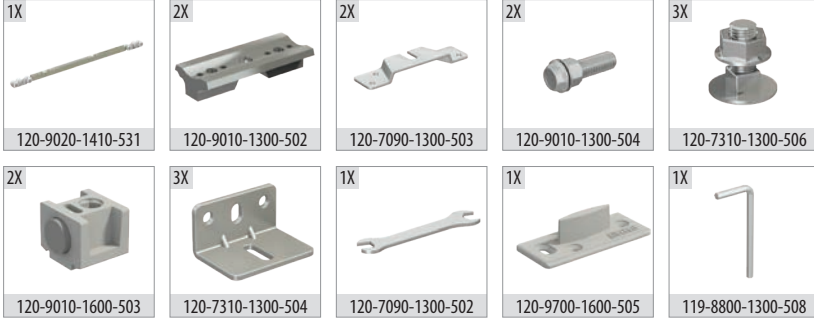

Ray Profilleri / Rail Profiles

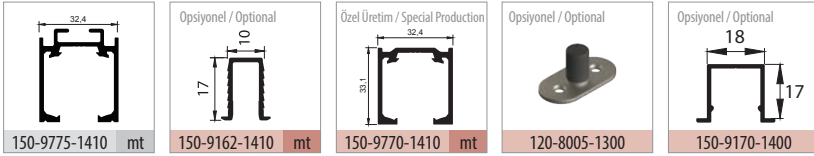

Uygulama / Application



* Duvar içi uygulamalarda, mekanizmanın hareketli teker bloğu sayesinde ray içi montajını kolaylaştırmaktadır.

* In wall-mounted applications, the mechanism's movable wheel block facilitates installation within the rail.

Teknik Detay / Technical Detail

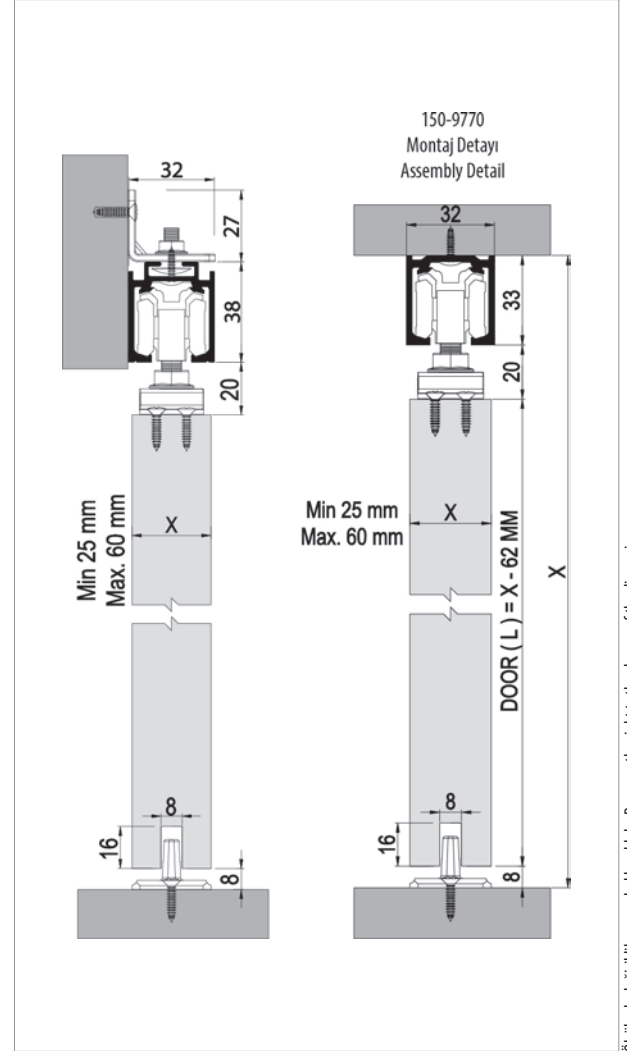

Ölçülerde değişiklik yapma hakkı saklıdır. Reserves the right to the change of the dimensions.

Kod / Code No	Açıklama / Description	Renk / Colour	Birim / Unit			Profil mt. / Profiles mt.	Bağ / Bnd.
120-9020-1410	40 Kg Yavaş. Sürme Kapı Sistemi / Sliding Door System - Two Way Soft Closing	Gri / Grey	1 Kapı / 1 Kit	12	360	- - -	-
150-9775-1410	Alüminyum Üst Ray Profili / Aluminium Top Rail Profile	Eloksal / Mat Anodized	mt.	-	-	2,0 - 3,0	6 ad/pcs
150-9162-1410	Alüminyum Alt Klavuz Profili / Aluminium Bottom Slider Profile	Eloksal / Mat Anodized	mt.	-	-	- 3,0	20 ad/pcs

DoorSlide 9080

120-9080

120 KG AYARLI ÇİFT YÖNE YAVAŞLATICILI SÜRME KAPI SİSTEMİ
120 KG ADJUSTABLE SLIDING DOOR SYSTEM - TWO WAY SOFT CLOSING

Yeni Ürün
New Product



Bilgi / Information

- Minimum kapı genişliği 650 mm olmalıdır.
- Min. Door width 650 mm

Yavaşlatıcı Alternatifi / Soft Closer Alternative

- Sistem üzerinde çift yöne yavaşlatıcı mevcuttur.
- The system has two way soft closing.



120-9080 1 Takım İçeriği / 1 Kit Includes



Ray Profilleri / Rail Profiles

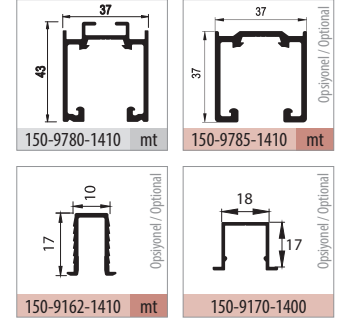

Teknik Detay / Technical Detail

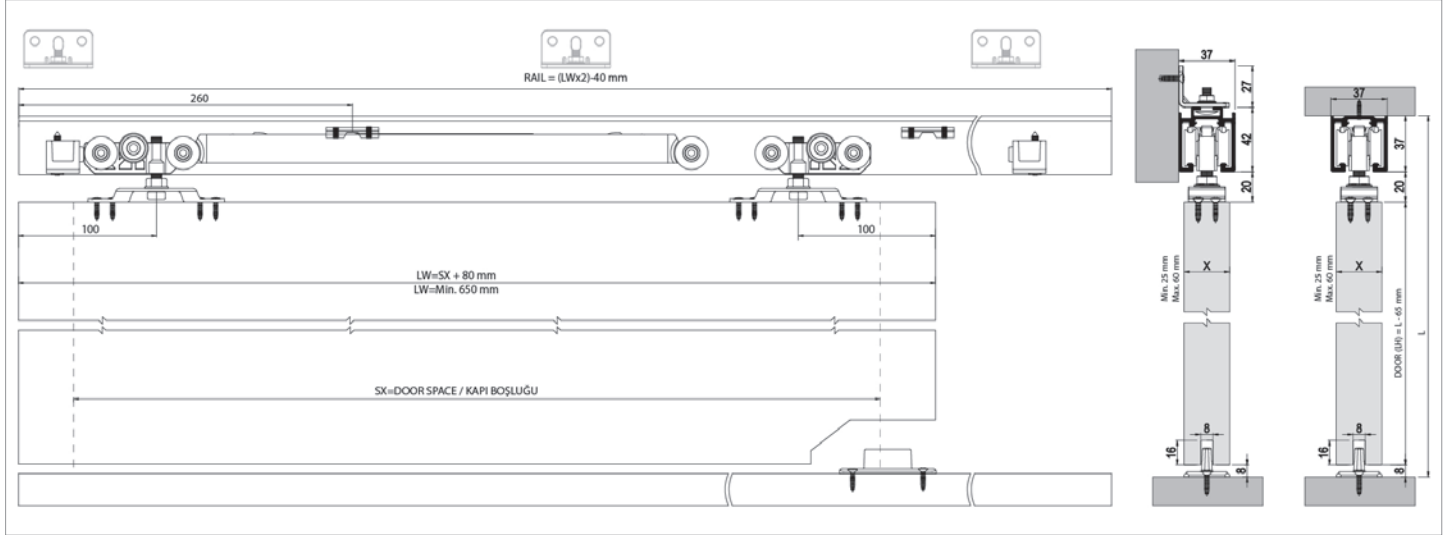

Uygulama / Application

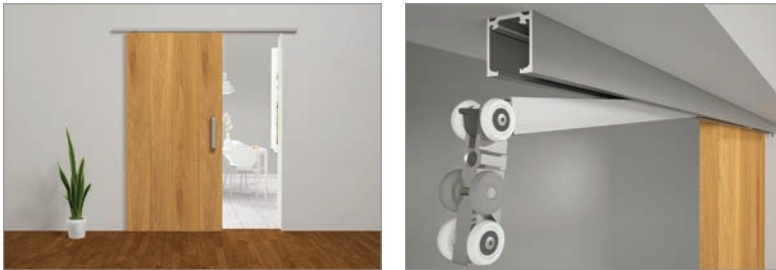

* Duvar içi uygulamalarda, mekanizmanın hareketli teker bloğu sayesinde ray içi montajını kolaylaştırmaktadır.

* In wall-mounted applications, the mechanism's movable wheel block facilitates installation within the rail.

Kod / Code No	Açıklama / Description	Renk / Colour	Birim / Unit			Profil mt. / Profiles mt.	Bağ / Bnd.
120-9080-1410	DoorSlide 9080 - 120 Kg Yavaş.Sürme Kapı Sistemi / Sliding Door System	Gri / Grey	1 Kapı / 1 Kit	12	576	-	-
120-8005-1300	Rulmanlı Alt Klavuz Teker / Lower Guide Wheel With Bearing	Gri / Grey	1 Adet / 1 Pcs.	12	576	-	-
150-9780-1410	Alüminyum Üst Ray Profili / Aluminium Top Rail Profile	Eloksal / Mat Anodized	mt.	-	-	2,0	3,0
150-9785-1410	Alüminyum Üst Ray Profili / Aluminium Top Rail Profile	Eloksal / Mat Anodized	mt.	-	-	2,0	3,0
150-9162-1410	Alüminyum Alt Klavuz Profili / Aluminium Bottom Slider Profile	Eloksal / Mat Anodized	mt.	-	-	-	3,0
150-9170-1400	Alüminyum Alt Klavuz Profili / Aluminium Bottom Slider Profile	Pres / Uncoated	mt.	-	-	-	3,0

DoorSlide 9085

120-9085

120 KG AYARLI ÇİFT YÖNE YAVAŞLATICILI SÜRME KAPI SİSTEMİ
120 KG ADJUSTABLE SLIDING DOOR SYSTEM - TWO WAY SOFT CLOSING

Yeni Ürün
New Product



Bilgi / Information

- Minimum kapı genişliği 650 mm olmalıdır.
- Min. Door width 650 mm

Yavaşlatıcı Alternatifi / Soft Closer Alternative

- Sistem üzerinde çift yöne yavaşlatıcı mevcuttur.
- The system has two way soft closing.



120-9085 1 Takım İçeriği / 1 Kit Includes



Ray Profilleri / Rail Profiles

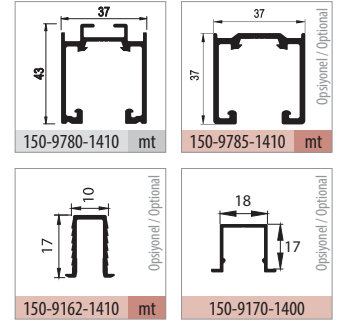

Teknik Detay / Technical Detail

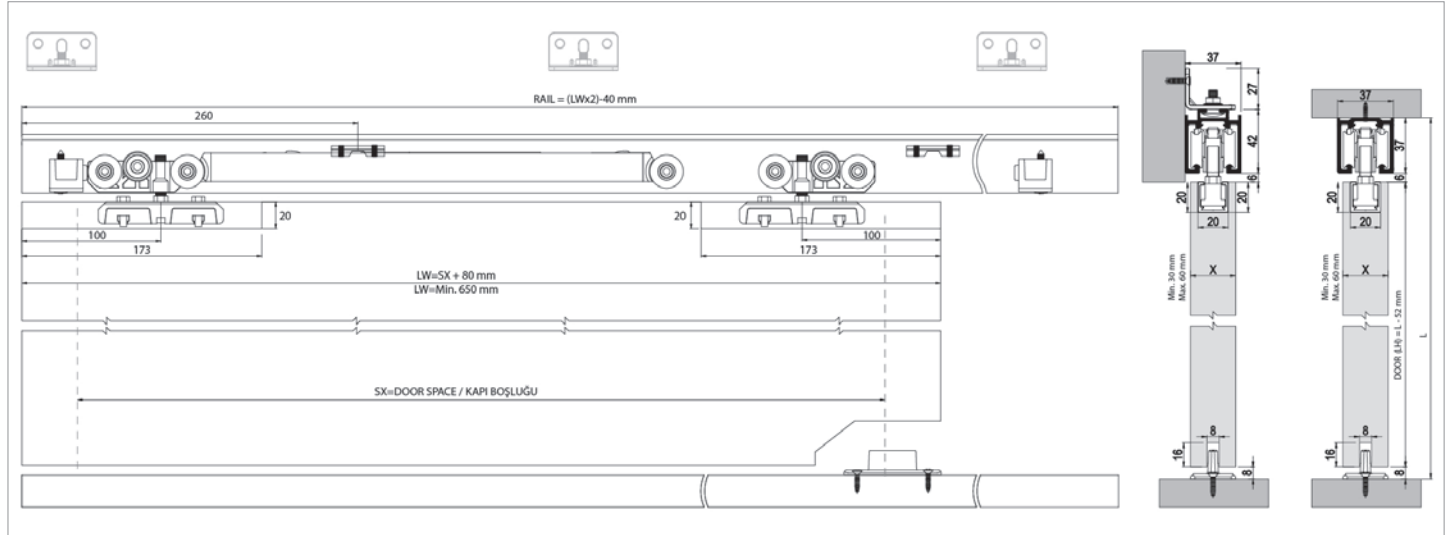

Uygulama / Application



* Duvar içi uygulamalarda, mekanizmanın hareketli teker bloğu sayesinde ray içi montajını kolaylaştırmaktadır.

* In wall-mounted applications, the mechanism's movable wheel block facilitates installation within the rail.

Kod / Code No	Açıklama / Description	Renk / Colour	Birim / Unit			Profil mt. / Profiles mt.	Bağ / Bnd.
120-9085-1410	DoorSlide 9085 - 120 Kg Yavaş Sürme Kapı Sistemi / Sliding Door System	Gri / Grey	1 Kapı / 1 Kit	12	576	-	-
120-8005-1300	Rulmanlı Alt Klavuz Teker / Lower Guide Wheel With Bearing	Gri / Grey	1 Adet / 1 Pcs.	12	576	-	-
150-9780-1410	Alüminyum Üst Ray Profili / Aluminium Top Rail Profile	Eloksal / Mat Anodized	mt.	-	-	2,0	3,0
150-9785-1410	Alüminyum Üst Ray Profili / Aluminium Top Rail Profile	Eloksal / Mat Anodized	mt.	-	-	2,0	3,0
150-9162-1410	Alüminyum Alt Klavuz Profili / Aluminium Bottom Slider Profile	Eloksal / Mat Anodized	mt.	-	-	-	3,0
150-9170-1400	Alüminyum Alt Klavuz Profili / Aluminium Bottom Slider Profile	Pres / Uncoated	mt.	-	-	-	3,0

DoorSlide 9090

120-9090

120 KG AYARLI ÇİFT YÖNE YAVAŞLATICILI SÜRME KAPI SİSTEMİ
120 KG ADJUSTABLE SLIDING DOOR SYSTEM - TWO WAY SOFT CLOSING

Yeni Ürün
New Product



Bilgi / Information

- Minimum kapı genişliği 610 mm olmalıdır.
- Min. Door width 610 mm

Yavaşlatıcı Alternatifi / Soft Closer Alternative

- Sistem üzerinde çift yöne yavaşlatıcı mevcuttur.
- The system has two way soft closing.



120-9090 1 Takım İçeriği / 1 Kit Includes



Ray Profilleri / Rail Profiles

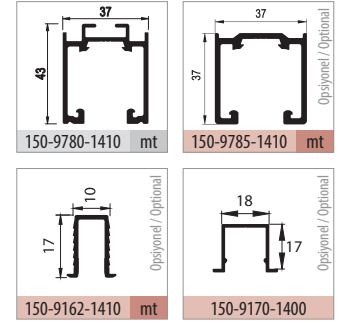

Teknik Detay / Technical Detail

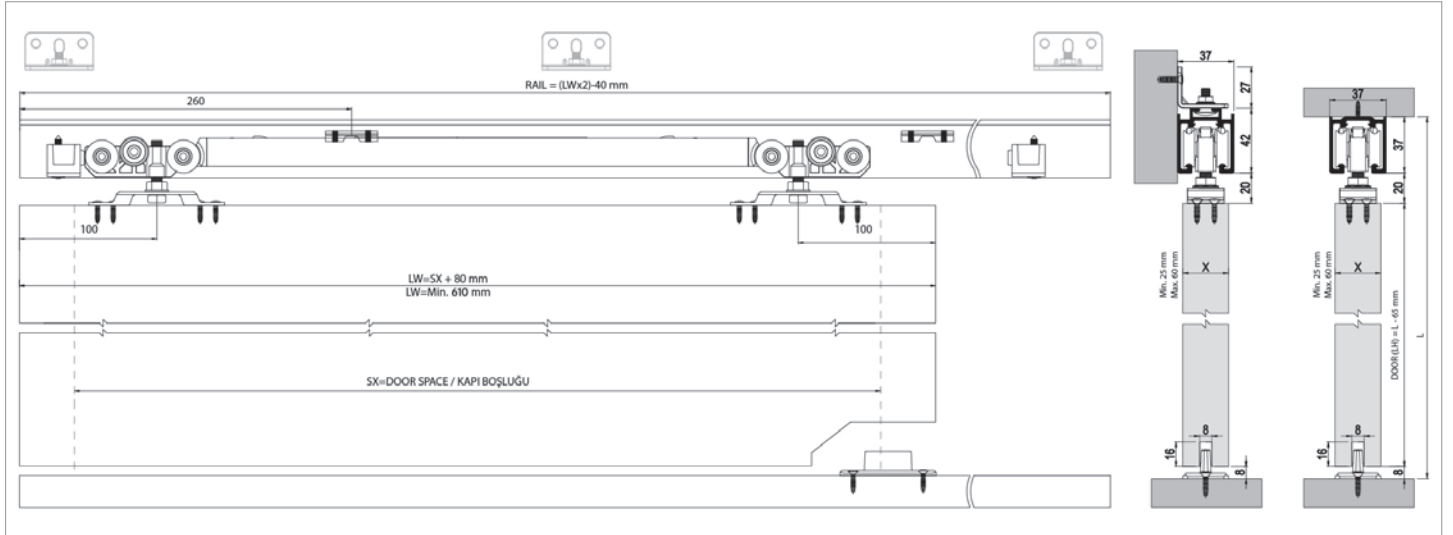

Uygulama / Application



* Duvar içi uygulamalarda, mekanizmanın hareketli teker bloğu sayesinde ray içi montajını kolaylaştırmaktadır.

* In wall-mounted applications, the mechanism's movable wheel block facilitates installation within the rail.

Kod / Code No	Açıklama / Description	Renk / Colour	Birim / Unit			Profil mt. / Profiles mt.	Bağ / Bnd.
120-9090-1410	DoorSlide 9080 - 120 Kg Yavaş.Sürme Kapı Sistemi / Sliding Door System	Gri / Grey	1 Kapı / 1 Kit	12	576	-	-
120-8005-1300	Rulmanlı Alt Klavuz Teker / Lower Guide Wheel With Bearing	Gri / Grey	1 Adet / 1 Pcs.	12	576	-	-
150-9780-1410	Alüminyum Üst Ray Profili / Aluminium Top Rail Profile	Eloksal / Mat Anodized	mt.	-	-	2,0	3,0
150-9785-1410	Alüminyum Üst Ray Profili / Aluminium Top Rail Profile	Eloksal / Mat Anodized	mt.	-	-	2,0	3,0
150-9162-1410	Alüminyum Alt Klavuz Profili / Aluminium Bottom Slider Profile	Eloksal / Mat Anodized	mt.	-	-	-	3,0
150-9170-1400	Alüminyum Alt Klavuz Profili / Aluminium Bottom Slider Profile	Pres / Uncoated	mt.	-	-	-	3,0



DoorSlide 9015

SINCE 1976	 Bearing Systems	EN 1527 100.000 CYCLES TEST 	 The Sliding System
---------------	---	---	---



DoorSlide 9701

120-9701

120 KG AYARLI TEK YÖNE YAVAŞLATICILI SÜRME KAPI SİSTEMİ
120 KG ADJUSTABLE SLIDING DOOR SYSTEM - ONE WAY SOFT CLOSING



Bilgi / Information

- Minimum kapı genişliği 500 mm olmalıdır.
- Min. Door width 500 mm

Yavaşlatıcı Alternatifi / Soft Closer Alternative

- Sistem üzerinde tek yöne yavaşlatıcı mevcuttur.
- The system has one way soft closing.



120-9701 1 Takım İçeriği / 1 Kit Includes

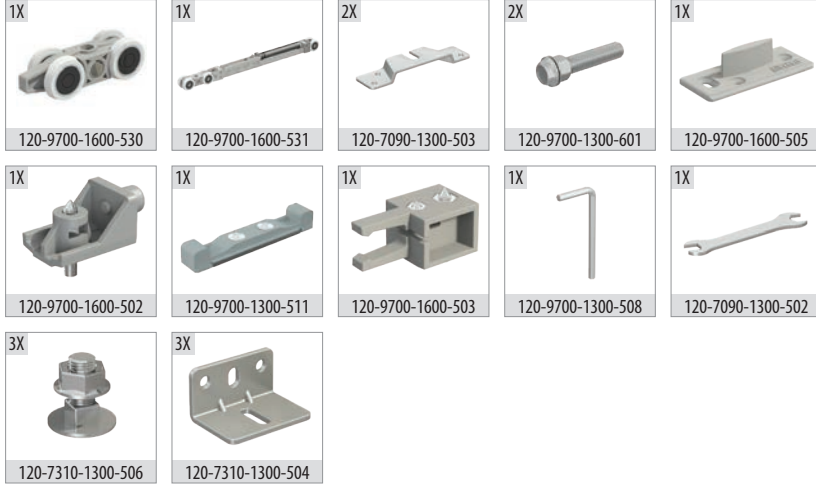

Ray Profilleri / Rail Profiles

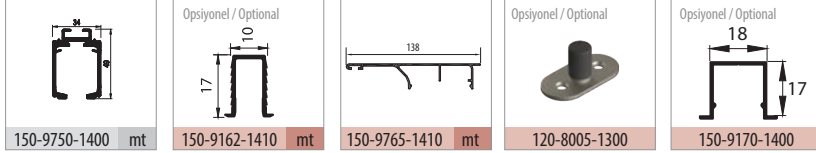

Uygulama / Application



Teknik Detay / Technical Detail

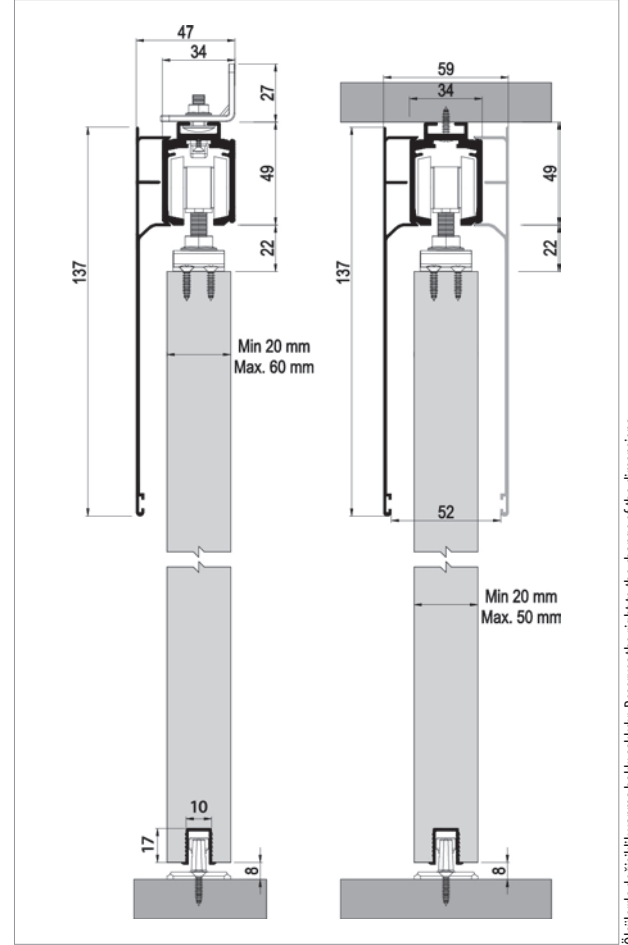

Ölçülerde değişiklik yapma hakkı saklıdır. Reserves the right to the change of the dimensions.

Kod / Code No	Açıklama / Description	Renk / Colour	Birim / Unit			Profil mt. / Profiles mt.	Bağ / Bnd.
120-9701-1600	120-9701 - 120 Kg Yavaşlatıcı Sürme Kapı Sistemi / Sliding Door System	Gri / Grey	1 Kapı / 1 Kit	12	360	- - -	-
150-9750-1400	Alüminyum Üst Ray Profili / Aluminium Top Rail Profile	Pres / Uncoated	mt.	-	-	2,0 - 3,0	2 ad/pcs
150-9162-1410	Alüminyum Üst Klavuz Profili / Aluminium Bottom Slider Profile	Eloksal / Mat Anodized	mt.	-	-	- 3,0	20 ad/pcs
150-9765-1410	Alüminyum Alın Kapama / Aluminium Cover Front	Eloksal / Mat Anodized	mt.	-	-	2,0 - 3,0	2 ad/pcs

DoorSlide 9706

120-9706

120 KG AYARLI TEK YÖNE YAVAŞLATICILI SÜRME KAPI SİSTEMİ
120 KG ADJUSTABLE SLIDING DOOR SYSTEM - ONE WAY SOFT CLOSING

Özel Üretim
Special Production



Bilgi / Information

- Minimum kapı genişliği 500 mm olmalıdır.
- Min. Door width 500 mm

Yavaşlatıcı Alternatifi / Soft Closer Alternative

- Sistem üzerinde tek yöne yavaşlatıcı mevcuttur.
- The system has one way soft closing.



120-9706 1 Takım İçeriği / 1 Kit Includes

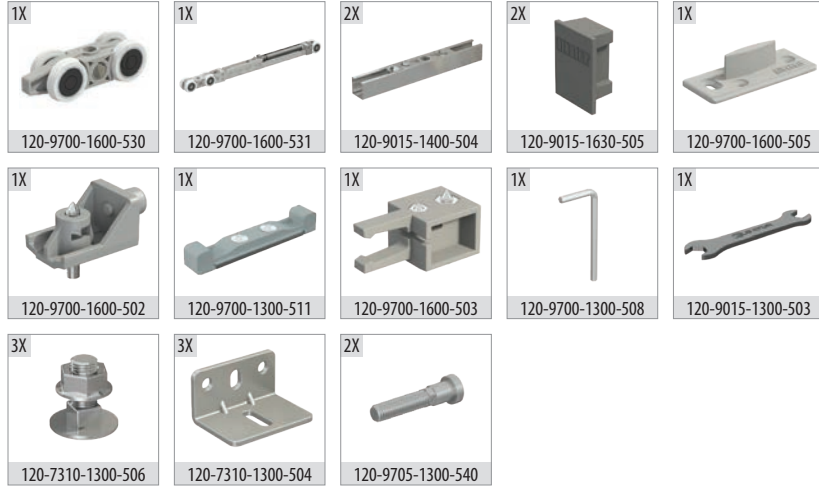

Ray Profilleri / Rail Profiles

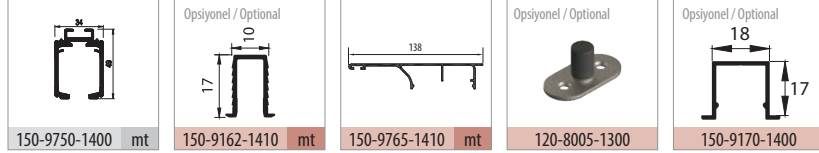

Uygulama / Application



Teknik Detay / Technical Detail

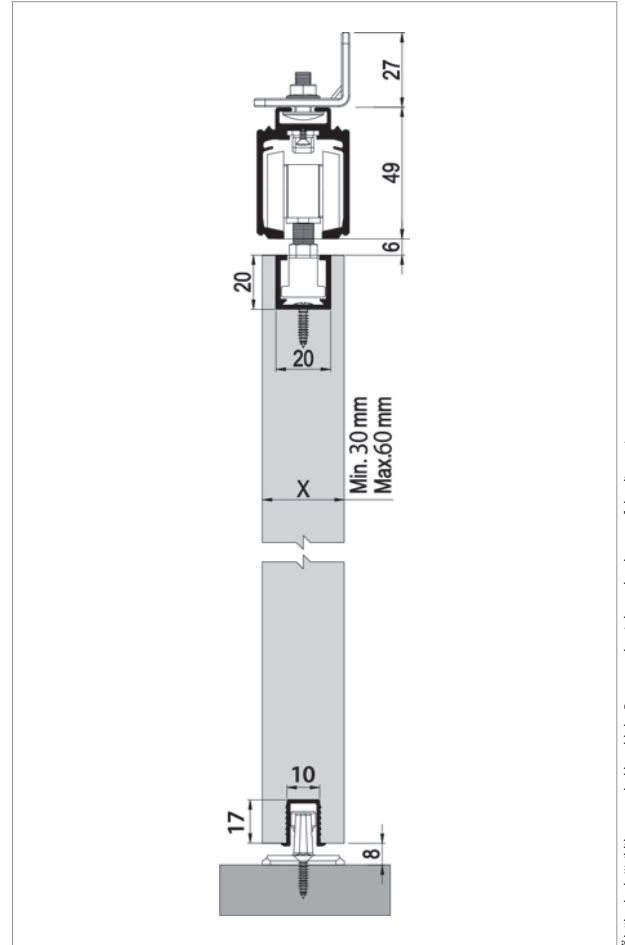

Ölçülerde değişiklik yapma hakkı saklıdır. Reserves the right to the change of the dimensions.

Kod / Code No	Açıklama / Description	Renk / Colour	Birim / Unit			Profil mt. / Profiles mt.	Bağ / Bnd.
120-9706-1600	120 Kg Yavaşlatıcı Sürme Kapı Sistemi / Sliding Door System - Has Soft Closing	Gri / Grey	1 Kapı / 1 Kit	8	400	- - -	-
150-9750-1400	Alüminyum Üst Ray Profili / Aluminium Top Rail Profile	Pres / Uncoated	mt.	-	-	2,0 - 3,0	2 ad/pcs
150-9162-1410	Alüminyum Üst Klavuz Profili / Aluminium Bottom Slider Profile	Eloksal / Mat Anodized	mt.	-	-	- - 3,0	20 ad/pcs
150-9765-1410	Alüminyum Alın Kapama / Aluminium Cover Front	Eloksal / Mat Anodized	mt.	-	-	2,0 - 3,0	2 ad/pcs

DoorSlide 9720

120-9720

120 KG AYARLI ÇİFT YÖNE YAVAŞLATICILI SÜRME KAPI SİSTEMİ
120 KG ADJUSTABLE SLIDING DOOR SYSTEM - TWO WAY SOFT CLOSING



Bilgi / Information

- Minimum kapı genişliği 830 mm olmalıdır.
- Min. Door width 830 mm

Yavaşlatıcı Alternatifi / Soft Closer Alternative

- Sistem üzerinde çift yöne yavaşlatıcı mevcuttur.
- The system has two way soft closing.



120-9720 1 Takım İçeriği / 1 Kit Includes

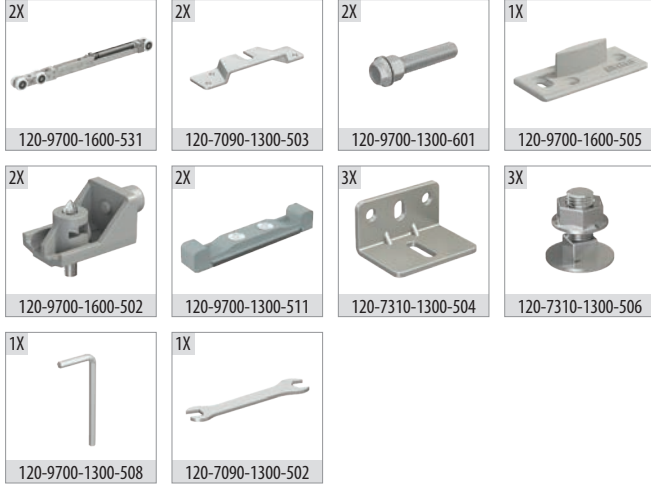

Ray Profilleri / Rail Profiles

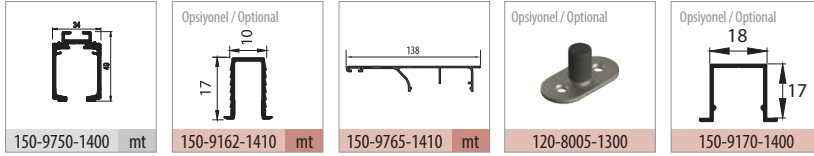

Uygulama / Application



Teknik Detay / Technical Detail

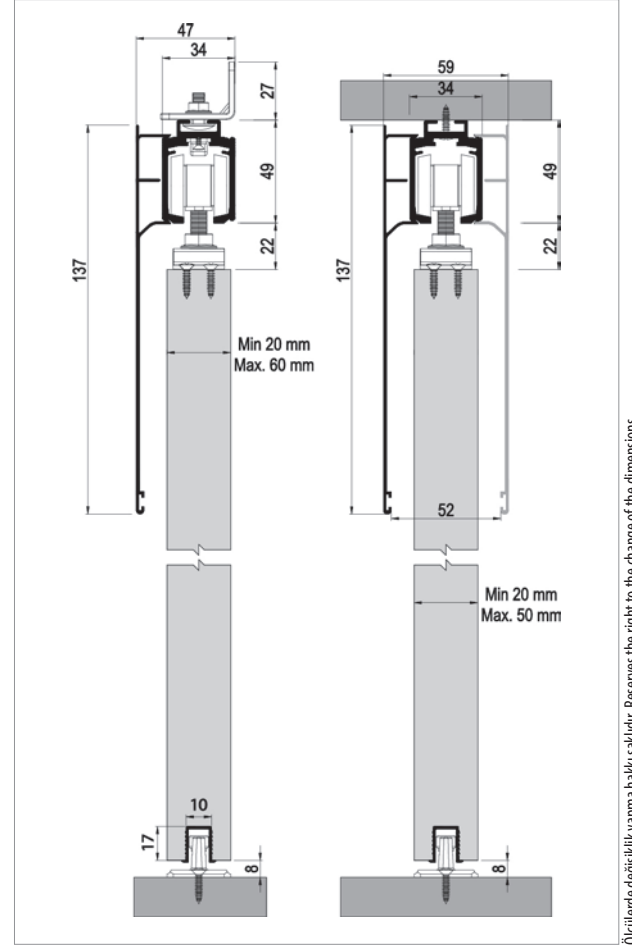

Ölçülerde değişiklik yapma hakkı saklıdır. Reserves the right to the change of the dimensions.

Kod / Code No	Açıklama / Description	Renk / Colour	Birim / Unit			Profil mt. / Profiles mt.	Bağ / Bnd.
120-9720-1600	120 Kg Yavaşlatıcılı Sürme Kapı Sistemi / Sliding Door System - Has Soft Closing	Gri / Grey	1 Kapı / 1 Kit	8	400	- - -	-
150-9750-1400	Alüminyum Üst Ray Profili / Aluminium Top Rail Profile	Pres / Uncoated	mt.	-	-	2,0 - 3,0	2 ad/pcs
150-9162-1410	Alüminyum Alt Klavuz Profili / Aluminium Bottom Slider Profile	Eloksal / Mat Anodized	mt.	-	-	- - 3,0	20 ad/pcs
150-9765-1410	Alüminyum Alın Kapama / Aluminium Cover Front	Eloksal / Mat Anodized	mt.	-	-	2,0 - 3,0	2 ad/pcs

DoorSlide 9725

120-9725

120 KG AYARLI ÇİFT YÖNE YAVAŞLATICILI SÜRME KAPI SİSTEMİ
120 KG ADJUSTABLE SLIDING DOOR SYSTEM - TWO WAY SOFT CLOSING

Özel Üretim
Special Production



Bilgi / Information

- Minimum kapı genişliği 830 mm olmalıdır.
- Min. Door width 830 mm

Yavaşlatıcı Alternatifi / Soft Closer Alternative

- Sistem üzerinde çift yöne yavaşlatıcı mevcuttur.
- The system has two way soft closing.



120-9725 1 Takım İçeriği / 1 Kit Includes



Ray Profilleri / Rail Profiles

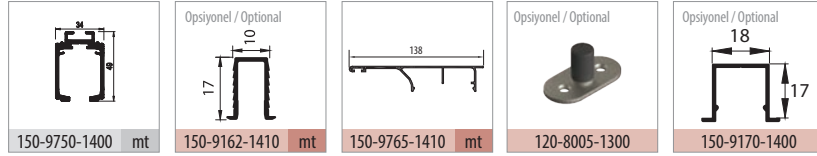

Uygulama / Application



Teknik Detay / Technical Detail

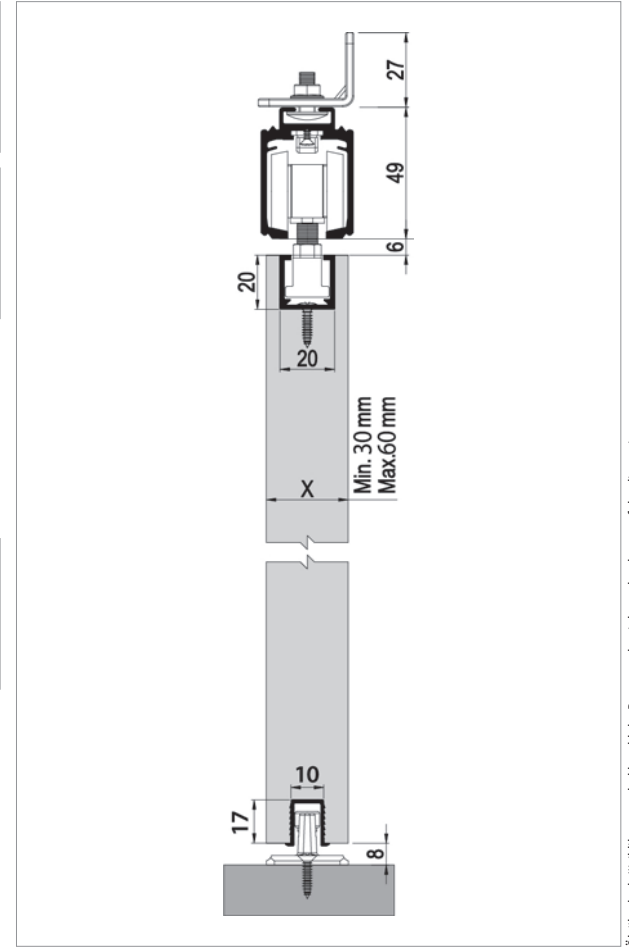

Kod / Code No	Açıklama / Description	Renk / Colour	Birim / Unit			Profil mt. / Profiles mt.	Bağ / Bnd.		
120-9725-1600	120 Kg Yavaşlatıcılı Sürme Kapı Sistemi / Sliding Door System - Has Soft Closing	Gri / Grey	1 Kapı / 1 Kit	8	400	-	-	-	
150-9750-1400	Alüminyum Üst Ray Profili / Aluminium Top Rail Profile	Pres / Uncoated	mt.	-	-	2,0	-	3,0	2 ad/pcs
150-9162-1410	Alüminyum Alt Klavuz Profili / Aluminium Bottom Slider Profile	Eloksal / Mat Anodized	mt.	-	-	-	-	3,0	20 ad/pcs
150-9765-1410	Alüminyum Alın Kapama / Aluminium Cover Front	Eloksal / Mat Anodized	mt.	-	-	2,0	-	3,0	2 ad/pcs

DoorSlide 7090

120-7090

80 KG AYARLI SÜRME KAPI SİSTEMİ
80 KG ADJUSTABLE SLIDING DOOR SYSTEM



120-7090 1 Takım İçeriği / 1 Kit Includes

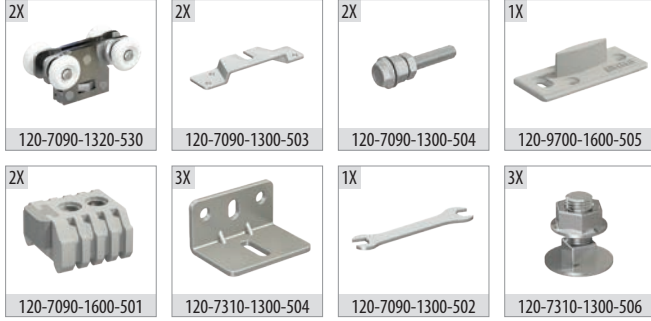

Ray Profilleri / Rail Profiles

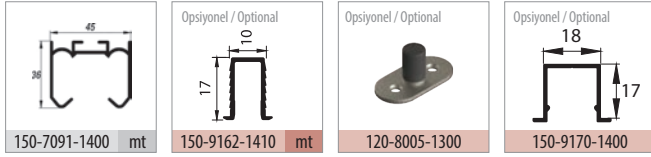

Uygulama / Application



Teknik Detay / Technical Detail

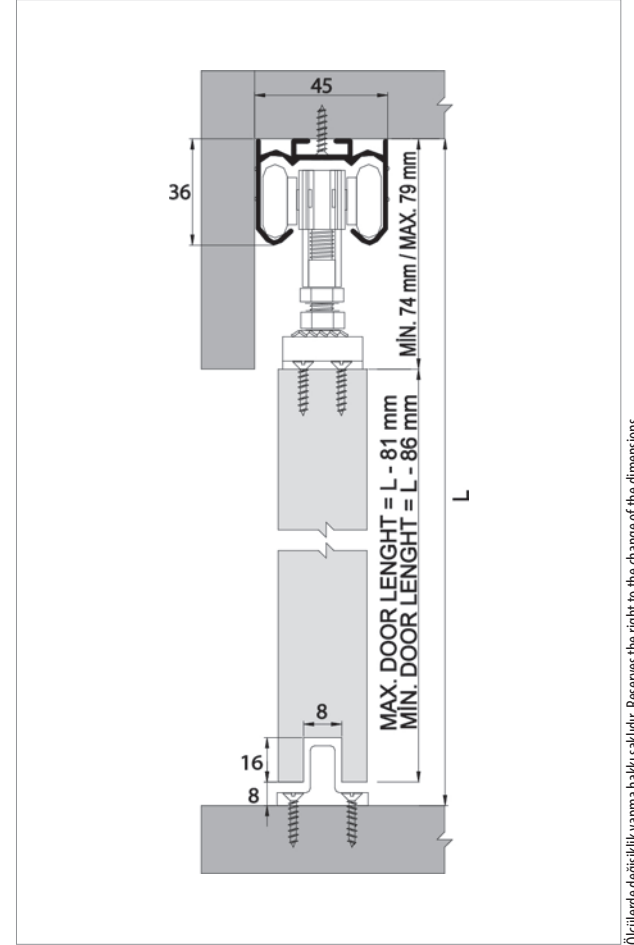

Ölçülerde değişiklik yapma hakkı saklıdır. Reserves the right to the change of the dimensions.

Kod / Code No	Açıklama / Description	Renk / Colour	Birim / Unit			Profil mt. / Profiles mt.			Bağ / Bnd.
120-7090-1320	80 Kg Sürme Kapı Sistemi / Sliding Door System	Galvaniz / Galvanized	1 Kapı / 1 Kit	24	576	-	-	-	-
150-7091-1400	Alüminyum Üst Ray Profili / Aluminium Top Rail Profile	Pres / Uncoated	mt.	-	-	2,0	-	3,0	6 ad/pcs
150-9162-1410	Alüminyum Alt Klavuz Profili / Aluminium Bottom Slider Profile	Eloksal / Mat Anodized	mt.	-	-	-	-	3,0	20 ad/pcs

DoorSlide 7099

120-7099

80 KG AYARLI SÜRME KAPI SİSTEMİ RULMANLI
80 KG ADJUSTABLE SLIDING DOOR SYSTEM HAS BALL BEARING



120-7099 1 Takım İçeriği / 1 Kit Includes

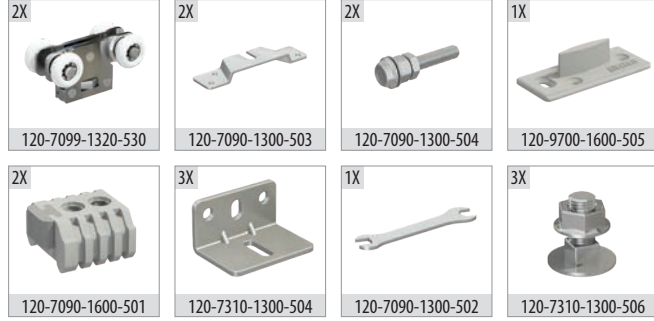

Ray Profilleri / Rail Profiles

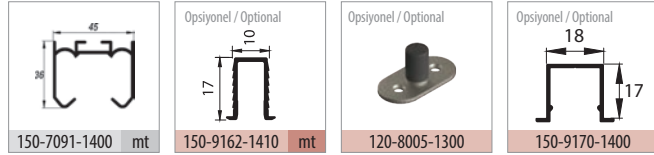

Uygulama / Application



Teknik Detay / Technical Detail

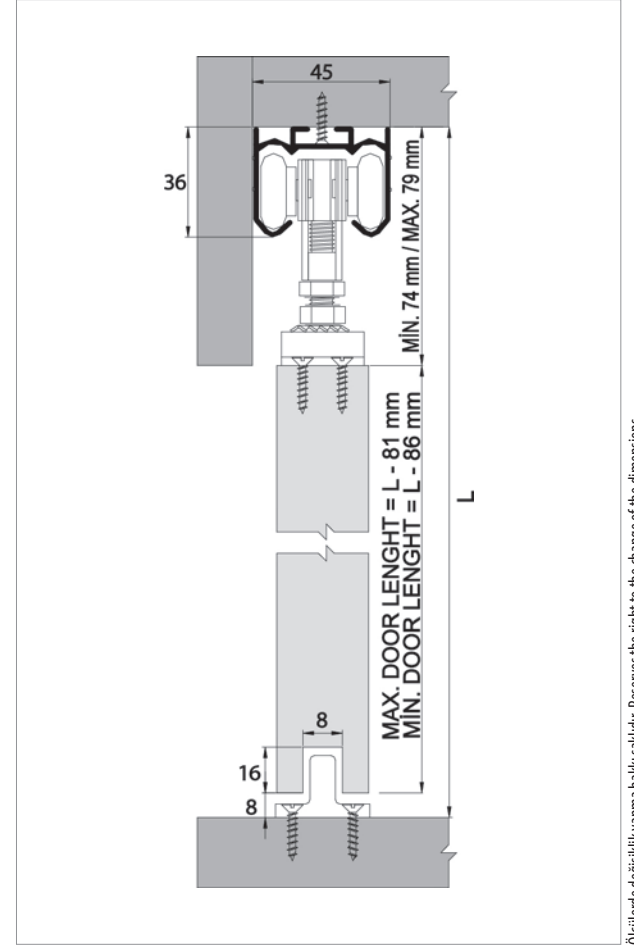

Ölçülerde değişiklik yapma hakkı saklıdır. Reserves the right to the change of the dimensions.

Kod / Code No	Açıklama / Description	Renk / Colour	Birim / Unit			Profil mt. / Profiles mt.	Bağ / Bnd.
120-7099-1320	80 Kg Sürme Kapı Sistemi / Sliding Door System	Galvaniz / Galvanized	1 Kapı / 1 Kit	24	576	-	-
150-7091-1400	Alüminyum Üst Ray Profili / Aluminium Top Rail Profile	Pres / Uncoated	mt.	-	-	2,0	3,0
150-9162-1410	Alüminyum Alt Klavuz Profili / Aluminium Bottom Slider Profile	Eloksal / Mat Anodized	mt.	-	-	-	3,0

DoorSlide 7310

120-7310

51 KG AYARLI SÜRME KAPI SİSTEMİ
51 KG ADJUSTABLE SLIDING DOOR SYSTEM



120-7310 1 Takım İçeriği / 1 Kit Includes



Ray Profilleri / Rail Profiles

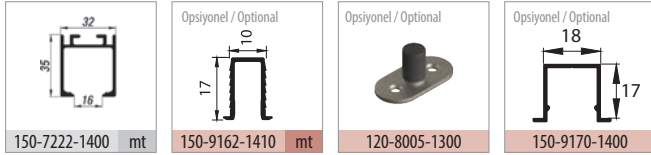

Uygulama / Application



Teknik Detay / Technical Detail

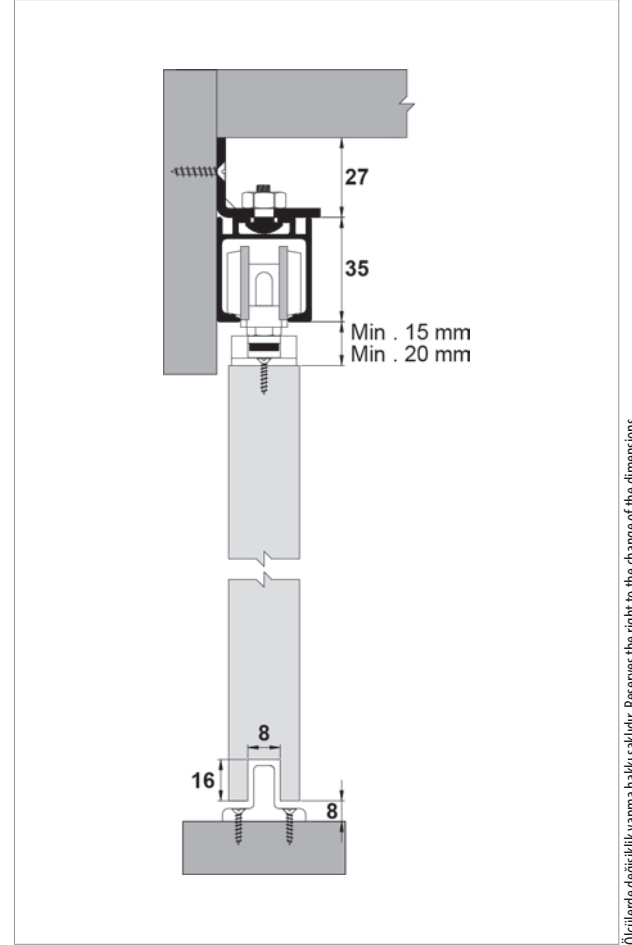

Ölçülerde değişiklik yapma hakkı saklıdır. Reserves the right to the change of the dimensions.

Kod / Code No	Açıklama / Description	Renk / Colour	Birim / Unit			Profil mt. / Profiles mt.			Bağ / Bnd.
120-7310-1600	51 Kg Sürme Kapı Sistemi / Sliding Door System	Gri / Grey	1 Kapı / 1 Kit	24	768	-	-	-	-
150-7222-1400	Alüminyum Üst Ray Profili / Aluminium Top Rail Profile	Pres/ Uncoated	mt.	-	-	2,0	-	3,0	6 ad/pcs
150-9162-1410	Alüminyum Alt Klavuz Profili / Aluminium Bottom Slider Profile	Eloksal / Mat Anodized	mt.	-	-	-	-	3,0	20 ad/pcs

DoorSlide 7340

120-7340

60 KG AYARLI SÜRME KAPI SİSTEMİ
60 KG ADJUSTABLE SLIDING DOOR SYSTEM

Özel Üretim
Special Production



120-7340 1 Takım İçeriği / 1 Kit Includes

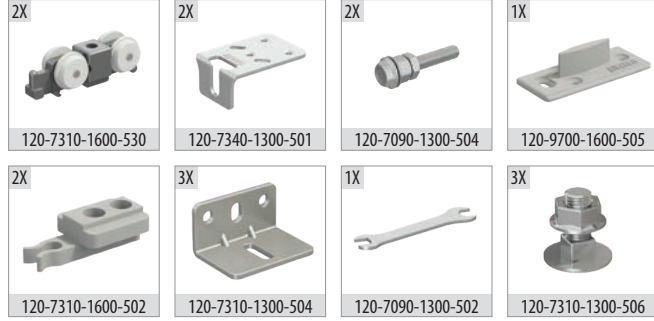

Ray Profilleri / Rail Profiles

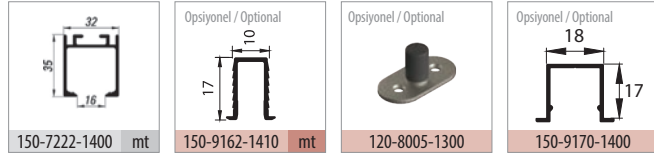

Uygulama / Application



Teknik Detay / Technical Detail

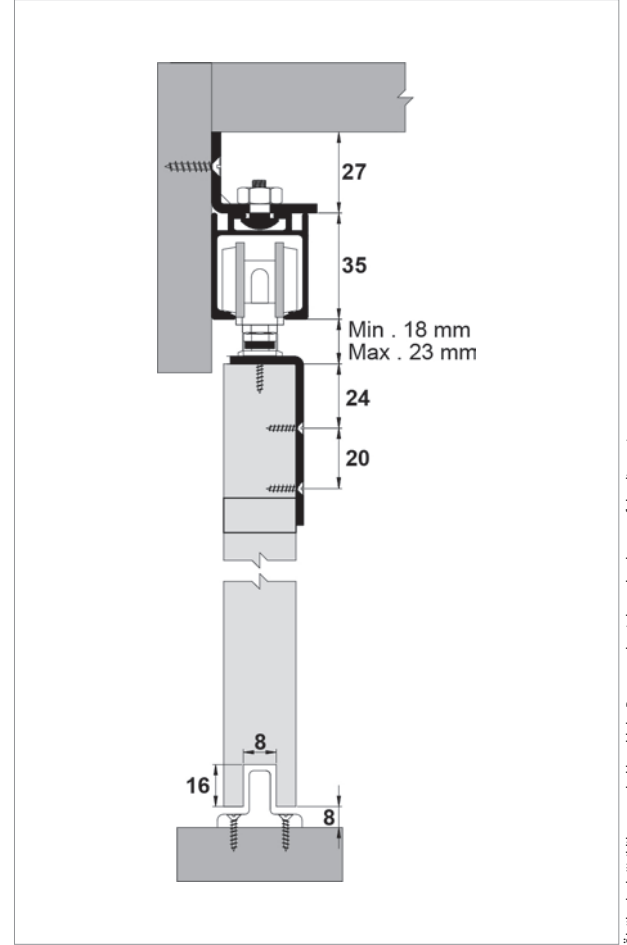

Ölçülerde değişiklik yapma hakkı saklıdır. Reserves the right to the change of the dimensions.

Kod / Code No	Açıklama / Description	Renk / Colour	Birim / Unit			Profil mt. / Profiles mt.	Bağ / Bnd.
120-7340-1300	60 Kg Sürme Kapı Sistemi / Sliding Door System	Gri / Grey	1 Kapı / 1 Kit	24	768	-	-
150-7222-1400	Alüminyum Üst Ray Profili / Aluminium Top Rail Profile	Pres / Uncoated	mt.	-	-	2,0	3,0
150-9162-1410	Alüminyum Alt Klavuz Profili / Aluminium Bottom Slider Profile	Eloksal / Mat Anodized	mt.	-	-	-	3,0

DoorSlide 7380

120-7380

80 KG AYARLI SÜRME KAPI SİSTEMİ RULMANLI
80 KG ADJUSTABLE SLIDING DOOR SYSTEM HAS BALL BEARING



120-7380 1 Takım İçeriği / 1 Kit Includes

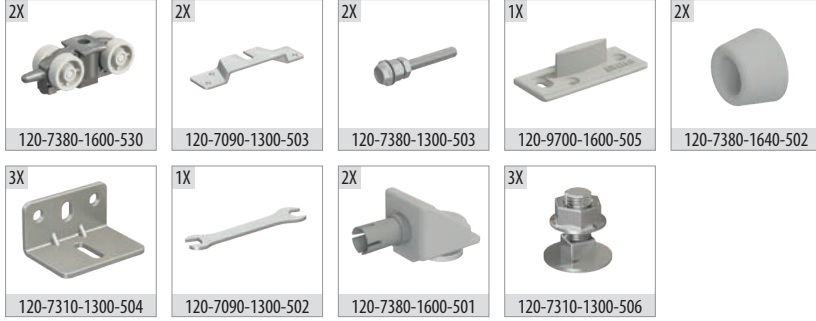

Ray Profilleri / Rail Profiles

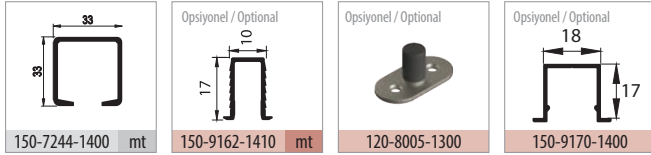

Uygulama / Application



Teknik Detay / Technical Detail

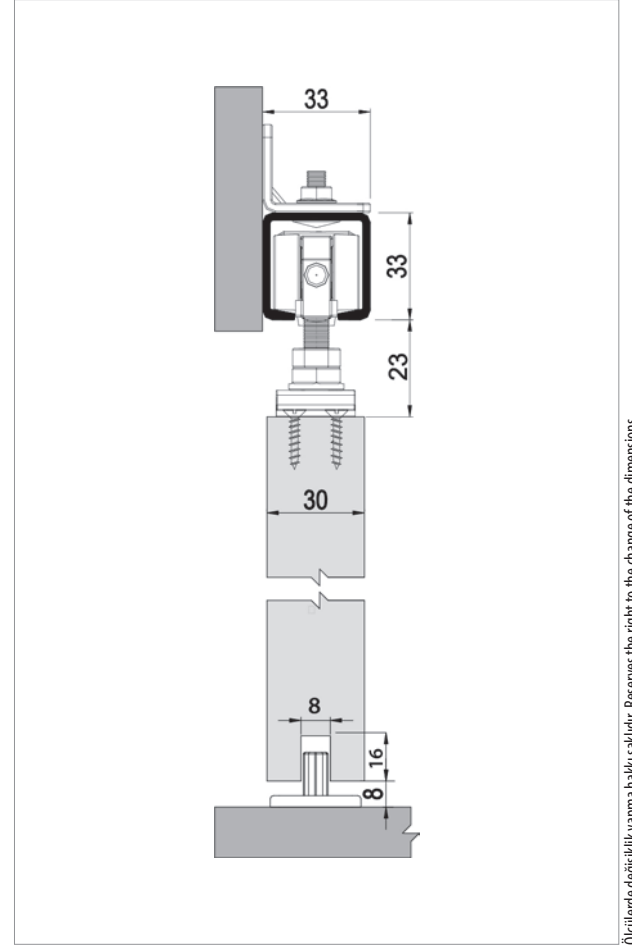

Ölçülerde değişiklik yapma hakkı saklıdır. Reserves the right to the change of the dimensions.

Kod / Code No	Açıklama / Description	Renk / Colour	Birim / Unit			Profil mt. / Profiles mt.			Bağ / Bnd.
120-7380-1600	80 Kg Sürme Kapı Sistemi / Sliding Door System	Gri / Grey	1 Kapı / 1 Kit	24	768	-	-	-	-
150-7244-1400	Alüminyum Üst Ray Profili / Aluminium Top Rail Profile	Pres / Uncoated	mt.	-	-	2,0	-	3,0	6 ad/pcs
150-9162-1410	Alüminyum Alt Klavuz Profili / Aluminium Bottom Slider Profile	Eloksal / Mat Anodized	mt.	-	-	-	-	3,0	20 ad/pcs

DoorSlide 9600

120-9600

160 KG AYARLI SÜRME KAPI SİSTEMİ
160 KGADJUSTABLE SLIDING DOOR SYSTEM

Özel Üretim
Special Production



120-9600 1 Takım İçeriği / 1 Kit Includes

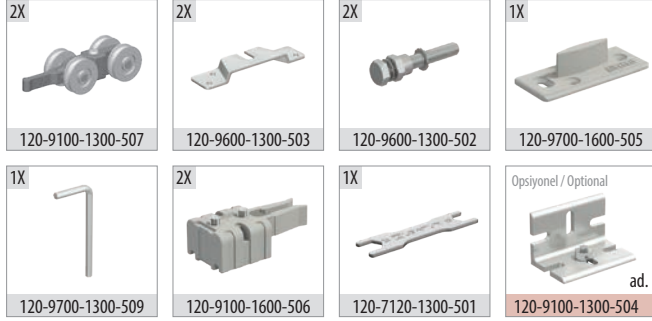

Ray Profilleri / Rail Profiles

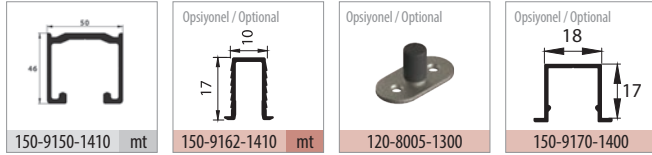

Uygulama / Application



Teknik Detay / Technical Detail

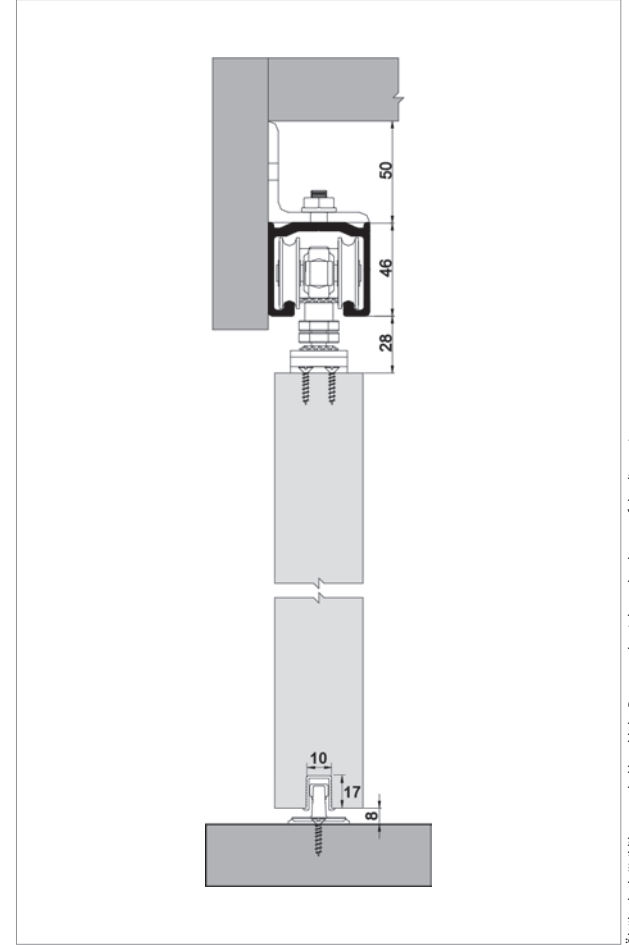

Ölçülerde değişiklik yapma hakkı saklıdır. Reserves the right to the change of the dimensions.

Kod / Code No	Açıklama / Description	Renk / Colour	Birim / Unit			Profil mt. / Profiles mt.			Bağ / Bnd.
120-9600-1300	160 Kg Sürme Kapı Sistemi / Sliding Door System	Gri / Grey	1 Kapı / 1 Kit	16	512	-	-	-	-
120-9100-1300-504	Askı Aparatı / Hanger Parts	Galvaniz / Galvanized	1 Adet / 1 Pcs	50	2.400	-	-	-	-
150-9150-1410	Alüminyum Üst Ray Profili / Aluminium Top Rail Profile	Eloksal / Mat Anodized	mt.	-	-	2,0	-	3,0	2 ad/pcs
150-9162-1410	Alüminyum Alt Klavuz Profili / Aluminium Bottom Slider Profile	Eloksal / Mat Anodized	mt.	-	-	-	-	3,0	20 ad/pcs

DoorSlide 9100

120-9100

250 KG AYARLI SÜRME KAPI SİSTEMİ
250 KG ADJUSTABLE SLIDING DOOR SYSTEM

Özel Üretim
Special Production



Bilgi / Information

- Minimum kapı panel kalınlığı 40 mm. olmalıdır.
- Door panel's thickness should be minimum 40 mm.



120-9100 1 Takım İçeriği / 1 Kit Includes

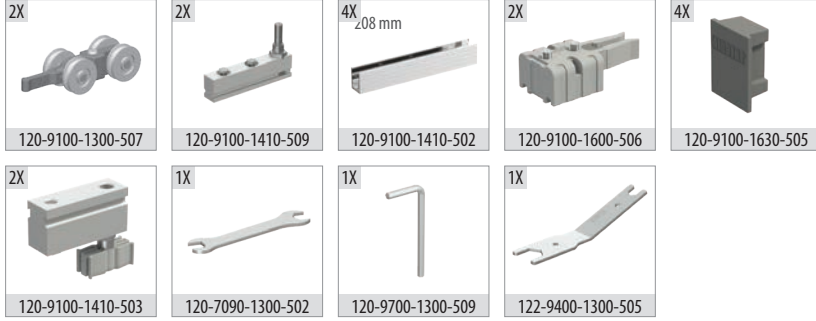

Ray Profilleri / Rail Profiles

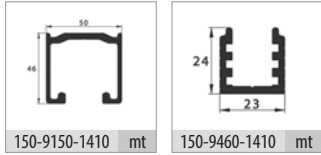

Opsiyonel Aksesuar / Optional Accessories



Uygulama / Application



Teknik Detay / Technical Detail

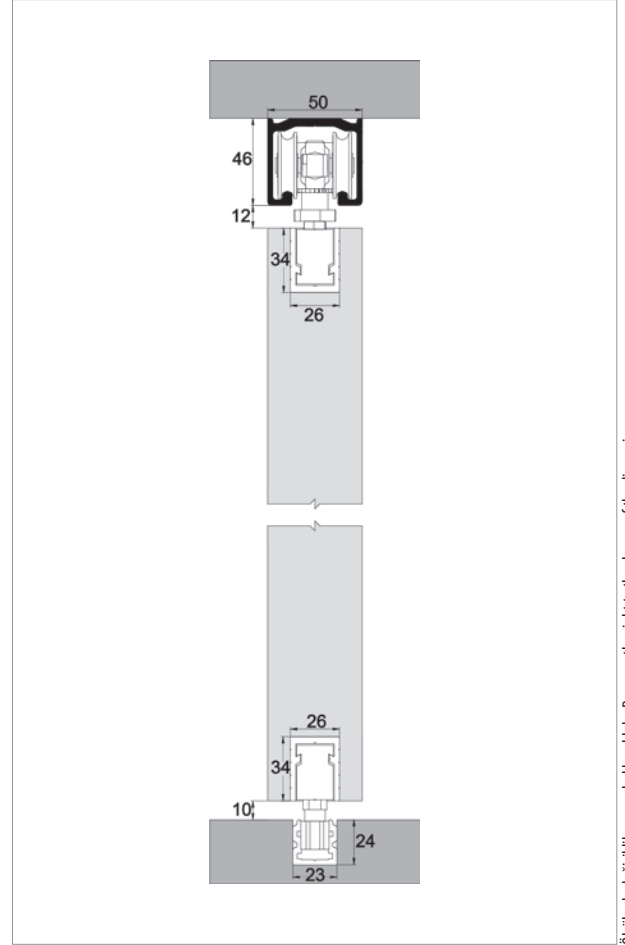

Ölçülerde değişiklik yapma hakkı saklıdır. Reserves the right to the change of the dimensions.

Kod / Code No	Açıklama / Description	Renk / Colour	Birim / Unit			Profil mt. / Profiles mt.			Bağ / Bnd.
120-9100-1300	250 Kg Sürme Kapı Sistemi / Sliding Door System	Grİ / Grey	1 Kapı / 1 Kit	12	360	-	-	-	-
120-9100-1300-504	Askı Aparatı / Hanger Parts	Galvaniz / Galvanized	1 Adet / 1 Pcs	50	2.400	-	-	-	-
150-9150-1410	Alüminyum Üst Ray Profili / Aluminium Top Rail Profile	Eloksal / Mat Anodized	mt.	-	-	2,0	-	3,0	2 ad/pcs
150-9460-1410	Alüminyum Alt Ray Profili / Aluminium Bottom Rail Profile	Eloksal / Mat Anodized	mt.	-	-	2,0	-	3,0	8 ad/pcs

DoorSlide 9200

120-9200

250 KG AYARLI SÜRME KAPI SİSTEMİ
250 KG ADJUSTABLE SLIDING DOOR SYSTEM

Özel Üretim
Special Production



Bilgi / Information

- Minimum kapı panel kalınlığı 40 mm. olmalıdır.
- Door panel's thickness should be minimum 40 mm.



120-9200 1 Takım İçeriği / 1 Kit Includes



Ray Profilleri / Rail Profiles

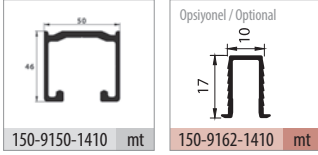

Opsiyonel Aksesuar / Optional Accessories



Uygulama / Application



Teknik Detay / Technical Detail

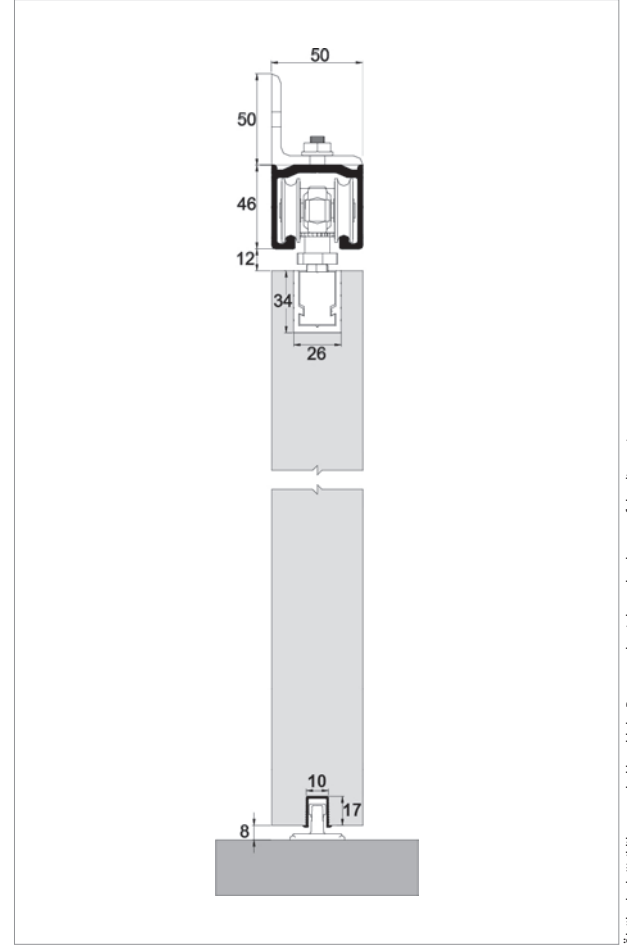

Ölçülerde değişiklik yapma hakkı saklıdır. Reserves the right to the change of the dimensions.

Kod / Code No	Açıklama / Description	Renk / Colour	Birim / Unit			Profil mt. / Profiles mt.	Bağ / Bnd.
120-9200-1300	250 Kg Sürme Kapı Sistemi / Sliding Door System	Gri / Grey	1 Kapı / 1 Kit	12	360	- - -	-
120-9100-1300-504	Askı Aparatı / Hanger Parts	Galvaniz / Galvanized	1 Adet / 1 Pcs	50	2.400	- - -	-
150-9150-1410	Alüminyum Üst Ray Profili / Aluminium Top Rail Profile	Eloksal / Mat Anodized	mt.	-	-	2,0 - 3,0	2 ad/pcs
150-9162-1410	Alüminyum Alt Klavuz Profili / Aluminium Bottom Slider Profile	Eloksal / Mat Anodized	mt.	-	-	- - 3,0	20 ad/pcs

DoorSlide 9700

120-9700

120 KG AYARLI SÜRME KAPI SİSTEMİ

120 KG ADJUSTABLE SLIDING DOOR SYSTEM



120-9700 1 Takım İçeriği / 1 Kit Includes

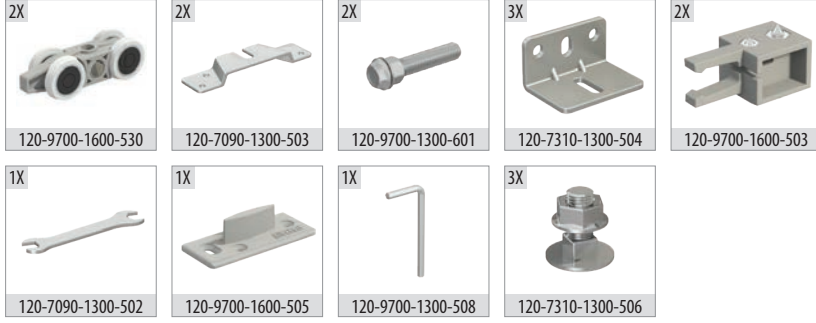

Ray Profilleri / Rail Profiles

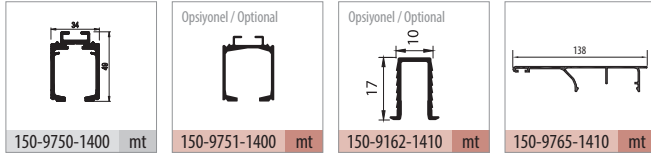

Opsiyonel Aksesuar / Optional Accessories

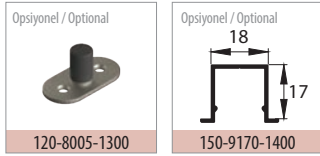

Uygulama / Application



Teknik Detay / Technical Detail

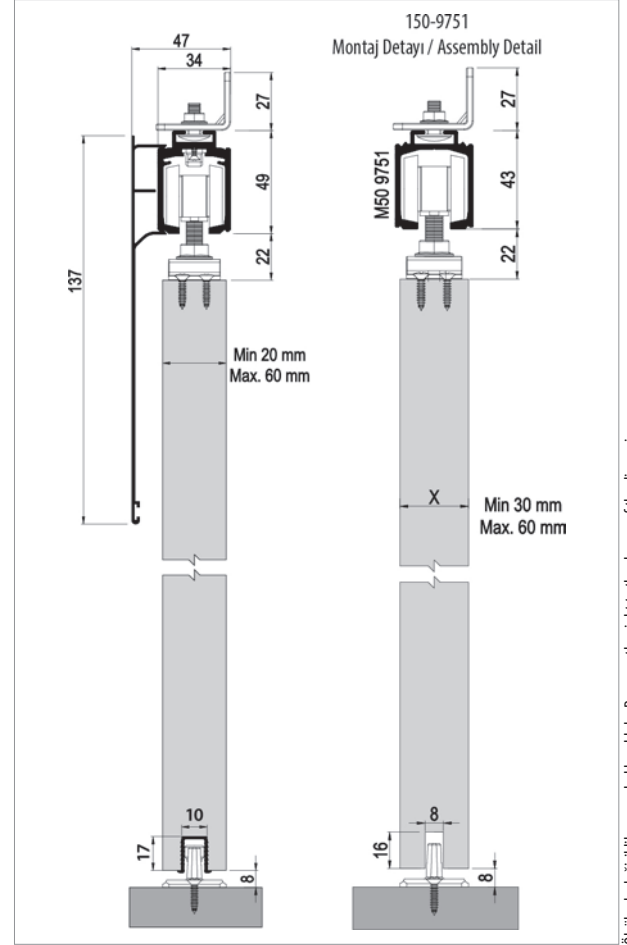

Ölçülerde değişiklik yapma hakkı saklıdır. Reserves the right to the change of the dimensions.

Kod / Code No	Açıklama / Description	Renk / Colour	Birim / Unit			Profil mt. / Profiles mt.			Bağ / Bnd.
120-9700-1600	120 Kg Sürme Kapı Sistemi / Sliding Door System	Gri / Grey	1 Kapı / 1 Kit	24	576	-	-	-	-
150-9750-1400	Alüminyum Üst Ray Profili / Aluminium Top Rail Profile	Pres / Uncoated	mt.	-	-	2,0	-	3,0	2 ad/pcs
150-9751-1400	Alüminyum Üst Ray Profili / Aluminium Top Rail Profile	Pres / Uncoated	mt.	-	-	2,0	-	3,0	2 ad/pcs
150-9162-1410	Alüminyum Alt Klavuz Profili / Aluminium Bottom Slider Profile	Eloksal / Mat Anodized	mt.	-	-	-	-	3,0	20 ad/pcs
150-9765-1410	Alüminyum Alın Kapama / Aluminium Cover Front	Eloksal / Mat Anodized	mt.	-	-	2,0	-	3,0	2 ad/pcs

DoorSlide 9705

120-9705

120 KG AYARLI SÜRME KAPI SİSTEMİ
120 KG ADJUSTABLE SLIDING DOOR SYSTEM

Özel Üretim
Special Production



120-9705 1 Takım İçeriği / 1 Kit Includes

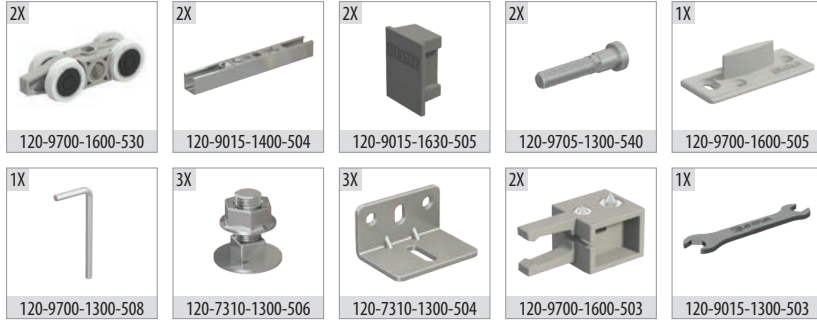

Ray Profilleri / Rail Profiles

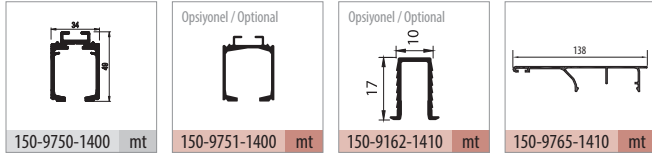

Opsiyonel Aksesuar / Optional Accessories

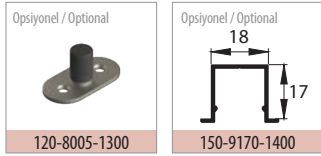

Uygulama / Application



Teknik Detay / Technical Detail

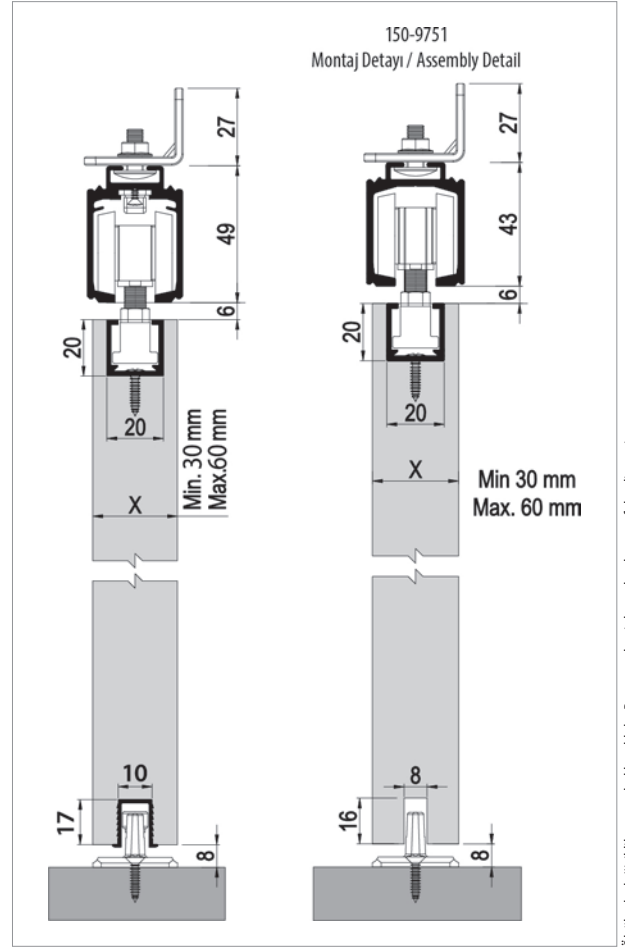

Ölçülerde değişiklik yapma hakkı saklıdır. Reserves the right to the change of the dimensions.

Kod / Code No	Açıklama / Description	Renk / Colour	Birim / Unit			Profil mt. / Profiles mt.	Bağ / Bnd.
120-9705-1600	120 Kg Sürme Kapı Sistemi / Sliding Door System	Gri / Grey	1 Kapı / 1 Kit	24	576	- - -	-
150-9750-1400	Alüminyum Üst Ray Profili / Aluminium Top Rail Profile	Pres / Uncoated	mt.	-	-	2,0 - 3,0	2 ad/pcs
150-9751-1400	Alüminyum Üst Ray Profili / Aluminium Top Rail Profile	Pres / Uncoated	mt.	-	-	2,0 - 3,0	2 ad/pcs
150-9162-1410	Alüminyum Alt Klavuz Profili / Aluminium Bottom Slider Profile	Eloksal / Mat Anodized	mt.	-	-	- 3,0	20 ad/pcs
150-9765-1410	Alüminyum Alın Kapama / Aluminium Cover Front	Eloksal / Mat Anodized	mt.	-	-	2,0 - 3,0	2 ad/pcs

DoorSlide 7120

120-7120

120 KG AYARLI SÜRME KAPI SİSTEMİ
120 KG ADJUSTABLE SLIDING DOOR SYSTEM



120-7120 1 Takım İçeriği / 1 Kit Includes



Ray Profilleri / Rail Profiles

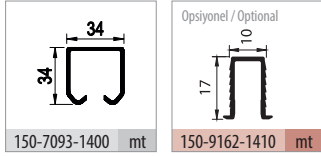

Opsiyonel Aksesuar / Optional Accessories

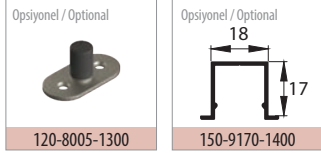

Uygulama / Application



Teknik Detay / Technical Detail

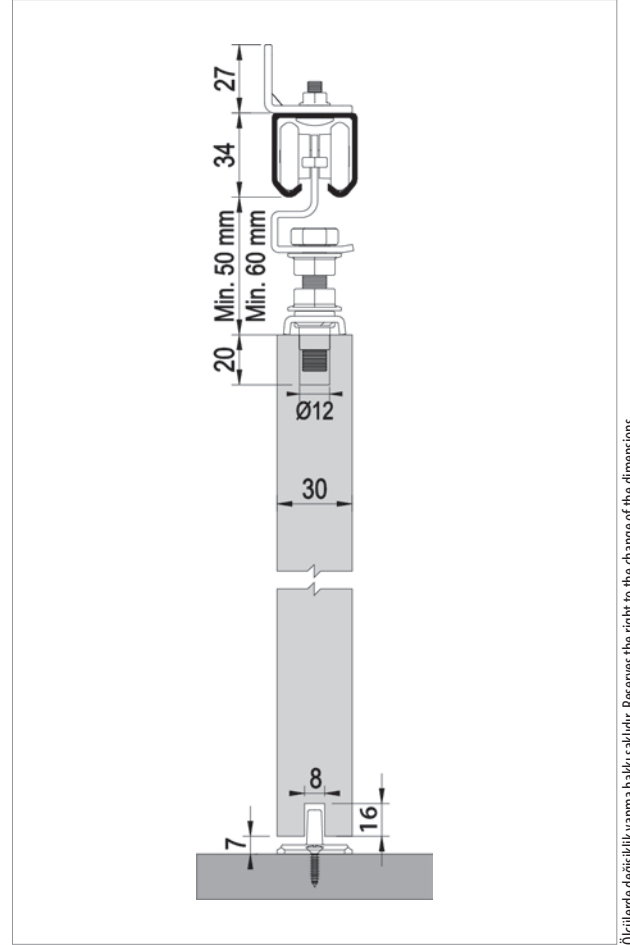

Ölçülerde değişiklik yapma hakkı saklıdır. Reserves the right to the change of the dimensions.

Kod / Code No	Açıklama / Description	Renk / Colour	Birim / Unit			Profil mt. / Profiles mt.	Bağ / Bnd.
120-7120-1300	120 Kg Sürme Kapı Sistemi / Sliding Door System	Gri / Grey	1 Kapı / 1 Kit	24	576	-	-
150-7093-1400	Alüminyum Üst Ray Profili / Aluminium Top Rail Profile	Pres / Uncoated	mt.	-	-	2,0	3,0
150-9162-1410	Alüminyum Alt Klavuz Profili / Aluminium Bottom Slider Profile	Eloksal / Mat Anodized	mt.	-	-	-	3,0

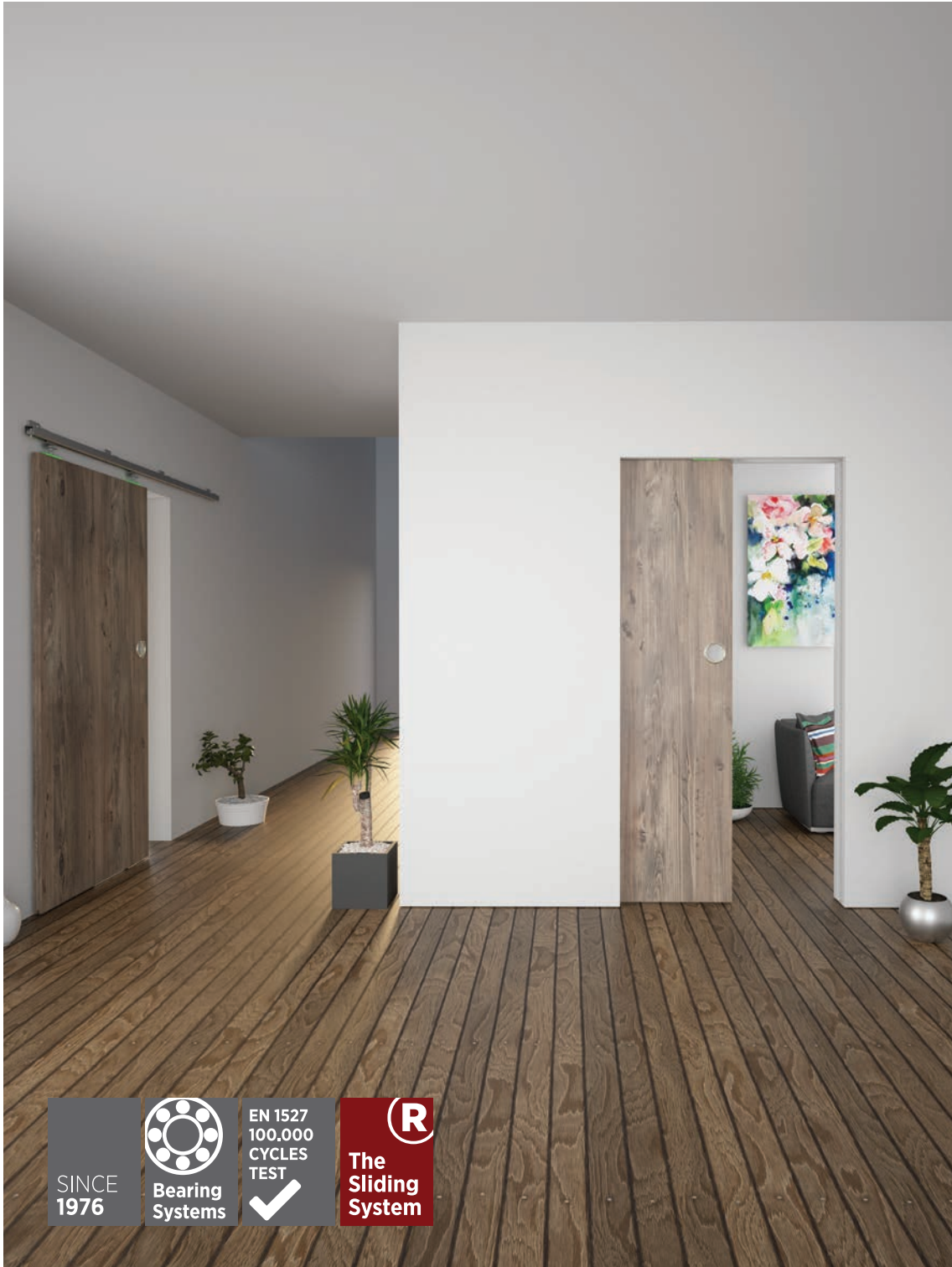

DoorSlide 7120

<p>SINCE 1976</p>	 <p>Bearing Systems</p>	<p>EN 1527 100.000 CYCLES TEST</p> 	 <p>The Sliding System</p>
-----------------------	--	--	---



Group 121

DoorSync[®] Wood

Ahşap Senkronize Sürme Kapı Serisi

Wooden Funicular Sliding Door Series



Bu serideki tüm ürünleri incelemek için
QR kodu okutabilirsiniz.















You can analyze the QR code to see all the
products in these series.



DoorSync 9820

SINCE 1976	 Bearing Systems	EN 1527 100.000 CYCLES TEST 	 The Sliding System
---------------	---	---	---



	OEM Kod OEM Code	Ürün Kodu Product Code	Sistem Tipi System Type	Panel Tipi Panel Type	Fren Yönü Brake Direc.	Panel mm	Taşıma Kg Capacity Kg	Video	Üst Ray Upper Rail	Alt Ray Lower Rail	Kapak Adeti Number of Doors	Yavaşlatıcı Dahil Soft Closer Including	Min. Kapı Genişlik mm Min. Door Width mm
1	121-9800	DoorSync 9800				20 - 60	120		150-9750	150-9162	2		-
2	121-9810	DoorSync 9810				20 - 50	80		150-7244	150-9162	2		-
3	121-9801	DoorSync 9801				20 - 60	120	✓	150-9750	150-9162	2	✓	500
4	121-9820	DoorSync 9820				20 - 60	120	✓	150-9750	150-9162	2	✓	830
5	121-9830	DoorSync 9830				20 - 60	60	✓	150-9775	150-9162	2	✓	650
6	121-9840	DoorSync 9840				20 - 60	40	✓	150-9775	150-9162	2	✓	450
7	121-9850	DoorSync 9850				25 - 60	60		150-9775	150-9162	2	✓	610
8	121-9880	DoorSync 9880				25 - 60	120	✓	150-9780	150-9162	2	✓	-
9	121-9890	DoorSync 9890				25 - 60	120		150-9780	150-9162	2	✓	-

• Verilen ölçüler bağlayıcı değildir. Önerilen kurulum ölçüleridir. Albatür ürün özelliklerinde haber vermeden değişiklik yapabilir.

• The given dimension are not binding. These are recommended asamble dimensions. Albatür can make alteration to product specification without notice.

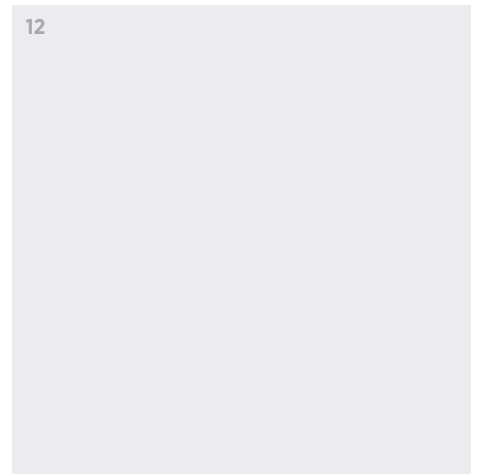
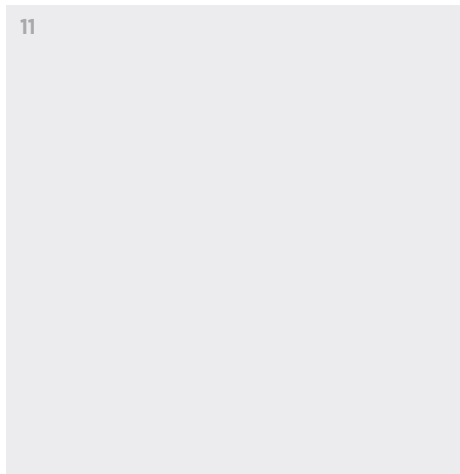
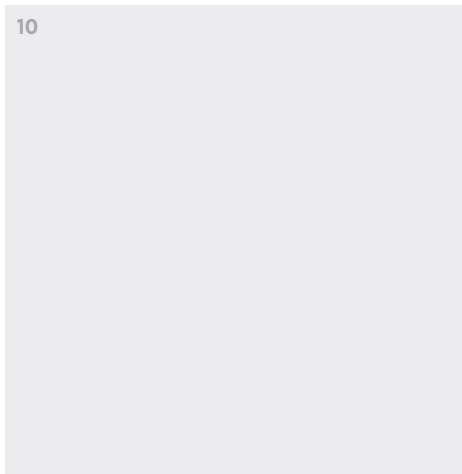
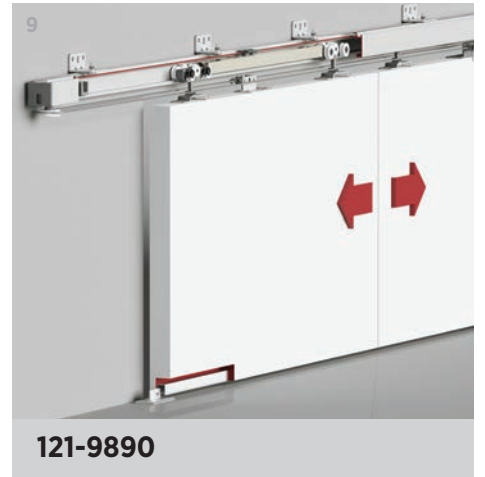
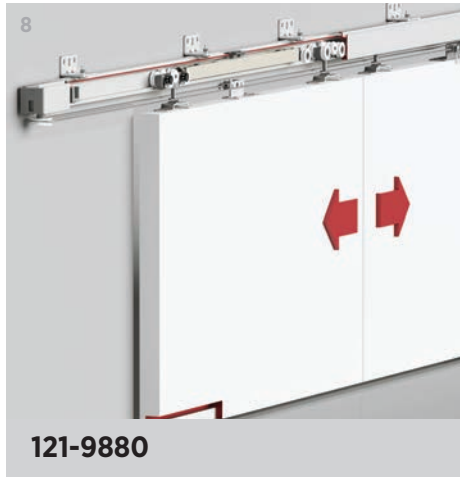
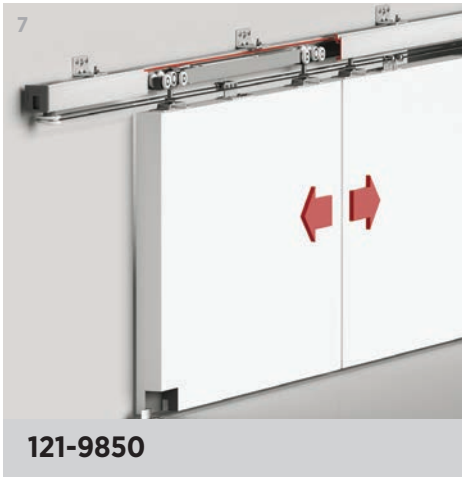
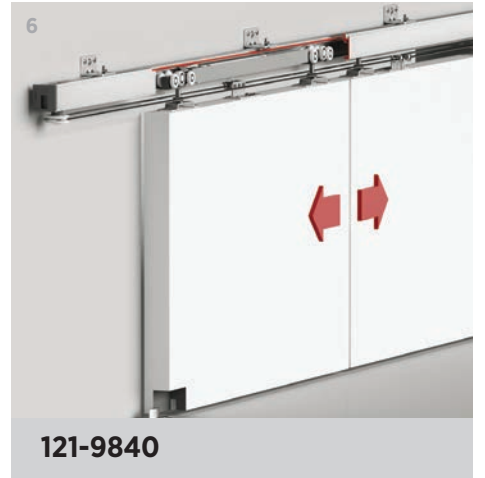
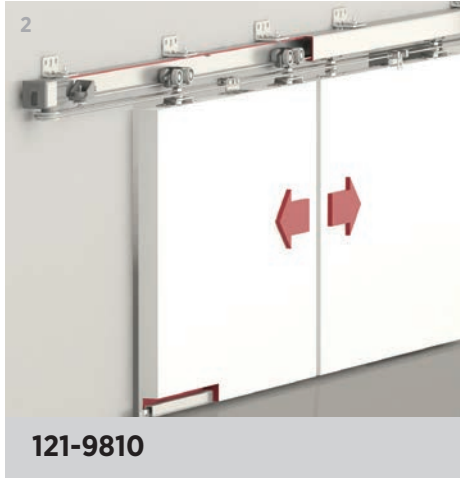

DoorSync 9800

121-9800

120 KG AYARLI HALATLI SÜRME KAPI SİSTEMİ
120 KG ADJUSTABLE FUNICULAR SLIDING DOOR SYSTEM

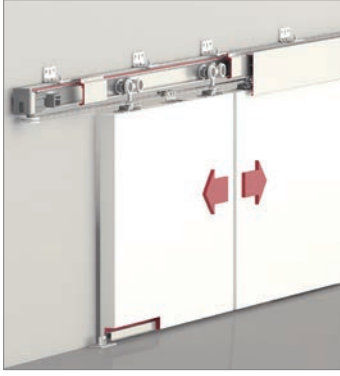

121-9800 1 Set İçeriği / 1 Set Includes

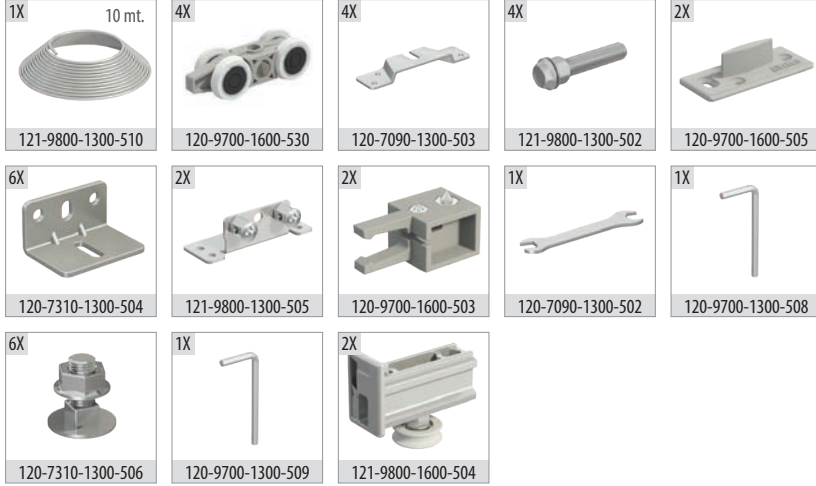

Ray Profilleri / Rail Profiles

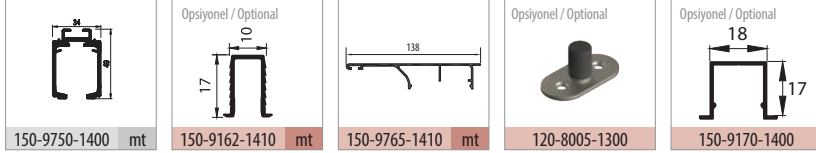

Uygulama / Application



Teknik Detay / Technical Detail

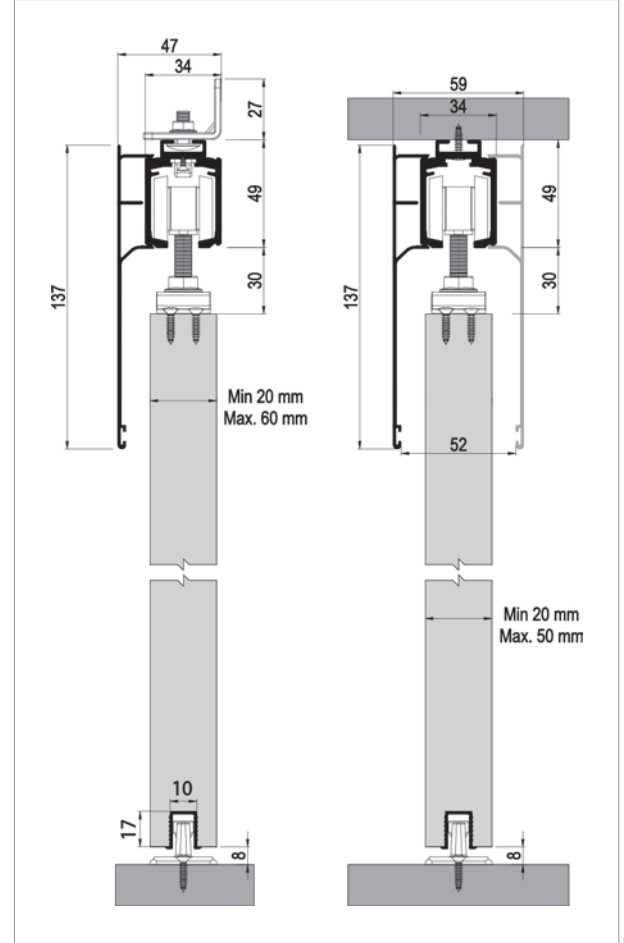

Kod / Code No	Açıklama / Description	Renk / Colour	Birim / Unit			Profil mt. / Profiles mt.			Bağ / Bnd.
121-9800-1600	120 Kg Senkronize Sürme Kapi Sistemi / Funicular Sliding Door System	Gri / Grey	2 Kapi / 1 Set	12	216	-	-	-	-
150-9750-1400	Alüminyum Üst Ray Profili / Aluminium Top Rail Profile	Pres / Uncoated	mt.	-	-	3,0	4,0	6,0	2 ad/pcs
150-9162-1410	Alüminyum Alt Klavuz Profili / Aluminium Bottom Slider Profile	Eloksal / Mat Anodized	mt.	-	-	3,0	-	-	20 ad/pcs
150-9765-1410	Alüminyum Alın Kapama / Aluminium Cover Front	Eloksal / Mat Anodized	mt.	-	-	3,0	4,0	6,0	2 ad/pcs

DoorSync 9810

121-9810

80 KG AYARLI HALATLI SÜRME KAPI SİSTEMİ
80 KG ADJUSTABLE FUNICULAR SLIDING DOOR SYSTEM

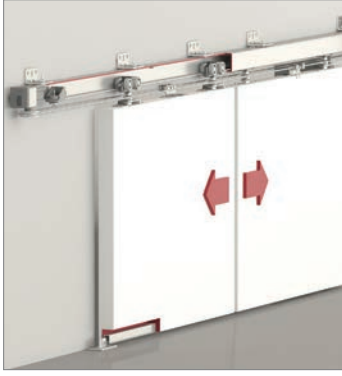

121-9810 1 Set İçeriği / 1 Set Includes



Ray Profilleri / Rail Profiles

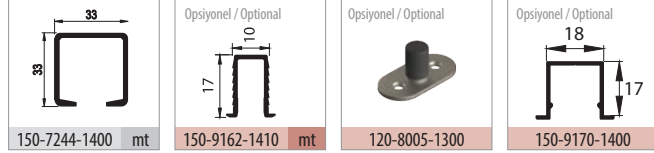

Uygulama / Application



Teknik Detay / Technical Detail

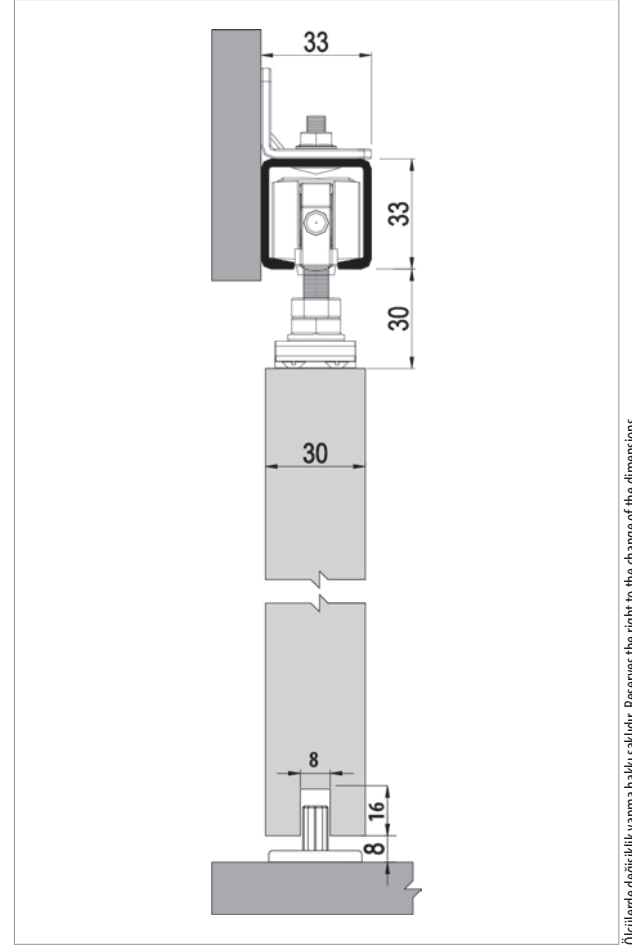

Ölçülerde değişiklik yapma hakkı saklıdır. Reserves the right to the change of the dimensions.

Kod / Code No	Açıklama / Description	Renk / Colour	Birim / Unit			Profil mt. / Profiles mt.			Bağ / Bnd.
121-9810-1600	80 Kg Senkronize Sürme Kapi Sistemi / Funicular Sliding Door System	Gri / Grey	2 Kapı / 1 Set	12	216	-	-	-	-
150-7244-1400	Alüminyum Üst Ray Profili / Aluminium Top Rail Profile	Pres / Uncoated	mt.	-	-	3,0	4,0	6,0	6 ad/pcs
150-9162-1410	Alüminyum Alt Klavuz Profili / Aluminium Bottom Slider Profile	Eloksal / Mat Anodized	mt.	-	-	-	-	3,0	20 ad/pcs

DoorSync 9801

121-9801

120 KG AYARLI TEK YÖNE YAVAŞLATICILI HALATLI SÜRME KAPI SİSTEMİ

120 KG ADJUSTABLE FUNICULAR SLIDING DOOR SYSTEM - ONE WAY SOFT CLOSING

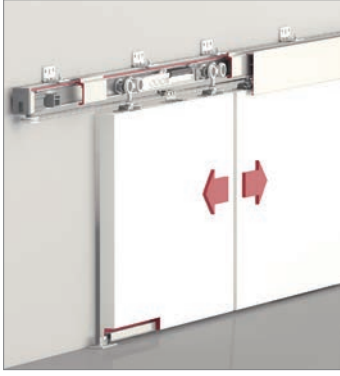

Bilgi / Information

- Minimum kapı genişliği 500 mm olmalıdır.
- Min. Door width 500 mm

Yavaşlatıcı Alternatifi / Soft Closer Alternative

- Sistem üzerinde tek yöne yavaşlatıcı mevcuttur.
- The system has one way soft closing.



121-9801 1 Set İçeriği / 1 Set Includes



Ray Profilleri / Rail Profiles

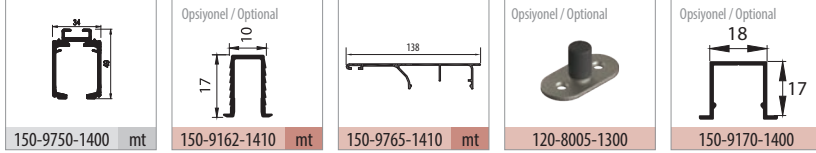

Uygulama / Application



Teknik Detay / Technical Detail

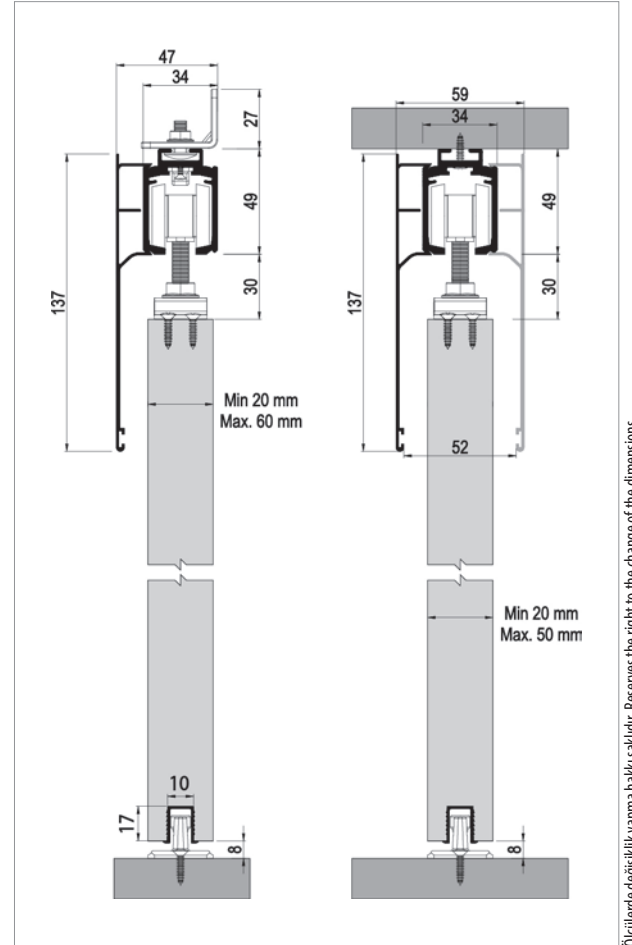

Ölçülerde değişiklik yapma hakkı saklıdır. Reserves the right to the change of the dimensions.

Kod / Code No	Açıklama / Description	Renk / Colour	Birim / Unit			Profil mt. / Profiles mt.	Bağ / Bnd.		
121-9801-1600	120 Kg Yavaşlatıcılı Halatlı Sürme Kapi Sistemi / Funicular Sliding Door Has Soft Closing	Gri / Grey	2 Kapi / 1 Set	12	216	-	-	-	
150-9750-1400	Alüminyum Üst Ray Profili / Aluminium Top Rail Profile	Pres / Uncoated	mt.	-	-	3,0	4,0	6,0	2 ad/pcs
150-9162-1410	Alüminyum Alt Klavuz Profili / Aluminium Bottom Slider Profile	Eloksal / Mat Anodized	mt.	-	-	3,0	-	-	20 ad/pcs
150-9765-1410	Alüminyum Alın Kapama / Aluminium Cover Front	Eloksal / Mat Anodized	mt.	-	-	3,0	4,0	6,0	2 ad/pcs

DoorSync 9820

121-9820

120 KG AYARLI ÇİFT YÖNE YAVAŞLATICILI HALATLI SÜRME KAPI SİSTEMİ
120 KG ADJUSTABLE FUNICULAR SLIDING DOOR SYSTEM - ONE WAY SOFT CLOSING

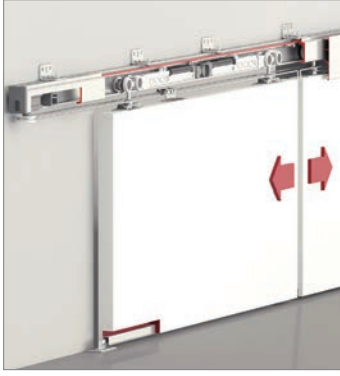

Bilgi / Information

- Minimum kapı genişliği 830 mm olmalıdır.
- Min. Door width 830 mm

Yavaşlatıcı Alternatifi / Soft Closer Alternative

- Sistem üzerinde çift yöne yavaşlatıcı mevcuttur.
- The system has two way soft closing.



121-9820 1 Set İçeriği / 1 Set Includes

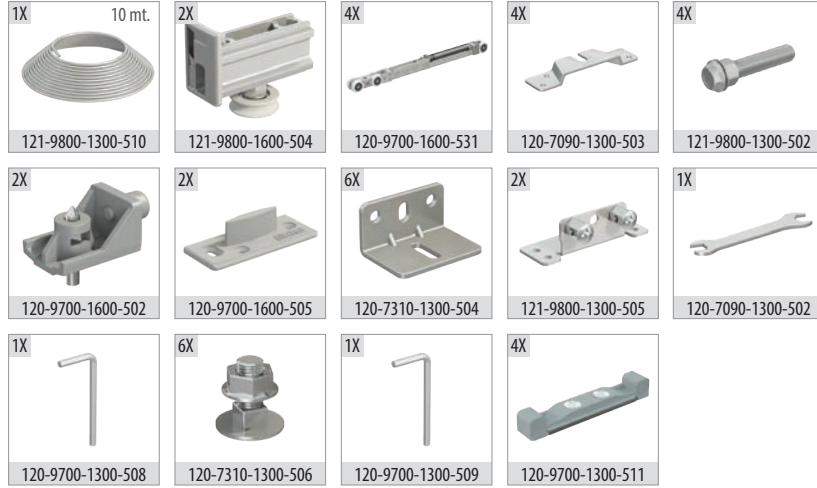

Ray Profilleri / Rail Profiles

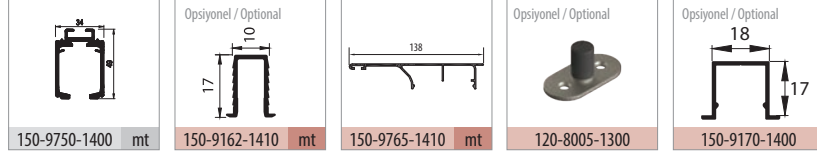

Uygulama / Application



Teknik Detay / Technical Detail

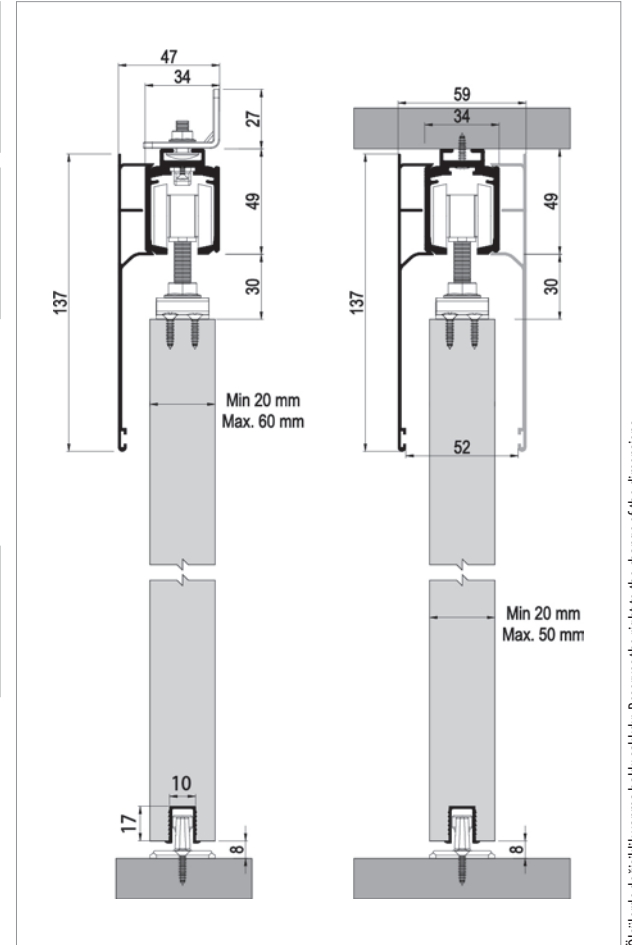

Ölçülerde değişiklik yapma hakkı saklıdır. Reserves the right to the change of the dimensions.

Kod / Code No	Açıklama / Description	Renk / Colour	Birim / Unit			Profil mt. / Profiles mt.	Bağ / Bnd.		
121-9820-1600	120 Kg Yavaşlatıcılı Halatlı Sürme Kapi Sistemi / Funicular Sliding Door Has Soft Closing	Gri / Grey	2 Kapi / 1 Set	12	216	-	-	-	
150-9750-1400	Alüminyum Üst Ray Profili / Aluminium Top Rail Profile	Pres / Uncoated	mt.	-	-	3,0	4,0	6,0	2 ad/pcs
150-9162-1410	Alüminyum Alt Klavuz Profili / Aluminium Bottom Slider Profile	Eloksal / Mat Anodized	mt.	-	-	3,0	-	-	20 ad/pcs
150-9765-1410	Alüminyum Alın Kapama / Aluminium Cover Front	Eloksal / Mat Anodized	mt.	-	-	3,0	4,0	6,0	2 ad/pcs

DoorSync 9830

121-9830

60 KG AYARLI ÇİFT YÖNE YAVAŞLATICILI HALATLI SÜRME KAPI SİSTEMİ
60 KG ADJUSTABLE FUNICULAR SLIDING DOOR SYSTEM - TWO WAY SOFT CLOSING

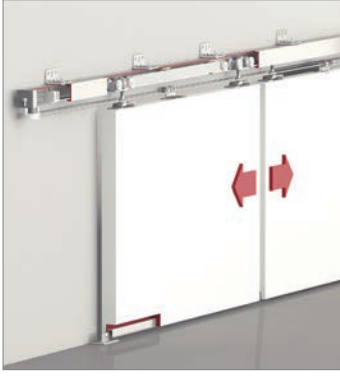

Bilgi / Information

- Minimum kapı genişliği 650 mm olmalıdır.
- Min. Door width 650 mm

Yavaşlatıcı Alternatifi / Soft Closer Alternative

- Sistem üzerinde çift yöne yavaşlatıcı mevcuttur.
- The system has two way soft closing.



121-9830 1 Set İçeriği / 1 Set Includes

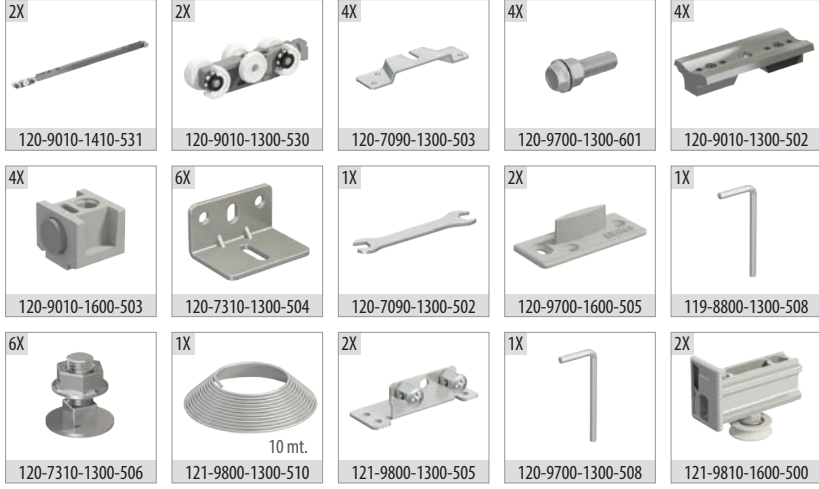

Ray Profilleri / Rail Profiles

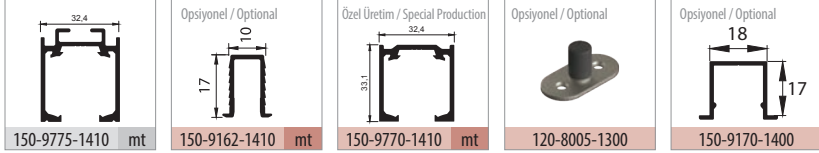

Uygulama / Application



Teknik Detay / Technical Detail

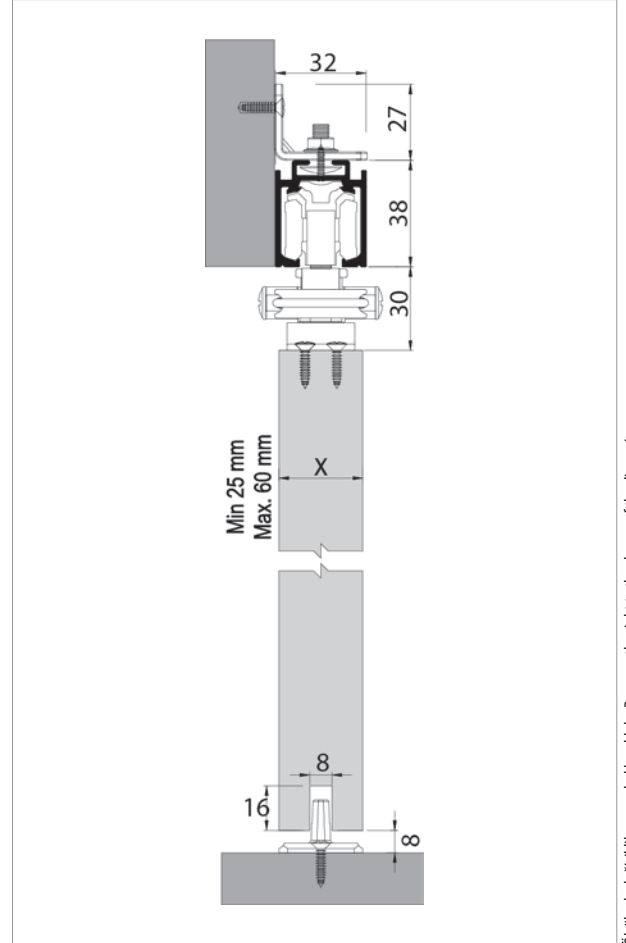

Ölçülerde değişiklik yapma hakkı saklıdır. Reserves the right to the change of the dimensions.

Kod / Code No	Açıklama / Description	Renk / Colour	Birim / Unit			Profil mt. / Profiles mt.			Bağ / Bnd.
121-9830-1410	60 Kg Yavaşlatıcı Halatlı Sürme Kapı Sistemi / Funicular Sliding Door Has Soft Closing	Gri / Grey	2 Kapı / 1 Set	4	160	-	-	-	-
150-9775-1410	Alüminyum Üst Ray Profili / Aluminium Top Rail Profile	Eloksal / Mat Anodized	mt.	-	-	3,0	4,0	6,0	6 ad/pcs
150-9162-1410	Alüminyum Alt Klavuz Profili / Aluminium Bottom Slider Profile	Eloksal / Mat Anodized	mt.	-	-	3,0	4,0	-	20 ad/pcs

DoorSync 9840

121-9840

40 KG AYARLI ÇİFT YÖNE YAVAŞLATICILI HALATLI SÜRME KAPI SİSTEMİ
40 KG ADJUSTABLE FUNICULAR SLIDING DOOR SYSTEM - TWO WAY SOFT CLOSING

Özel Üretim
Special Production

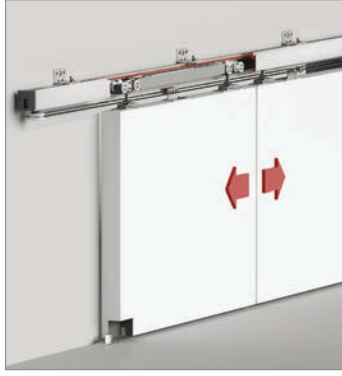

Bilgi / Information

- Minimum kapı genişliği 450 mm olmalıdır.
- Min. Door width 450 mm

Yavaşlatıcı Alternatifi / Soft Closer Alternative

- Sistem üzerinde çift yöne yavaşlatıcı mevcuttur.
- The system has two way soft closing.



121-9840 1 Set İçeriği / 1 Set Includes



Ray Profilleri / Rail Profiles

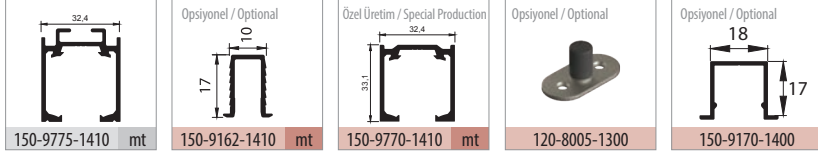

Uygulama / Application



Teknik Detay / Technical Detail

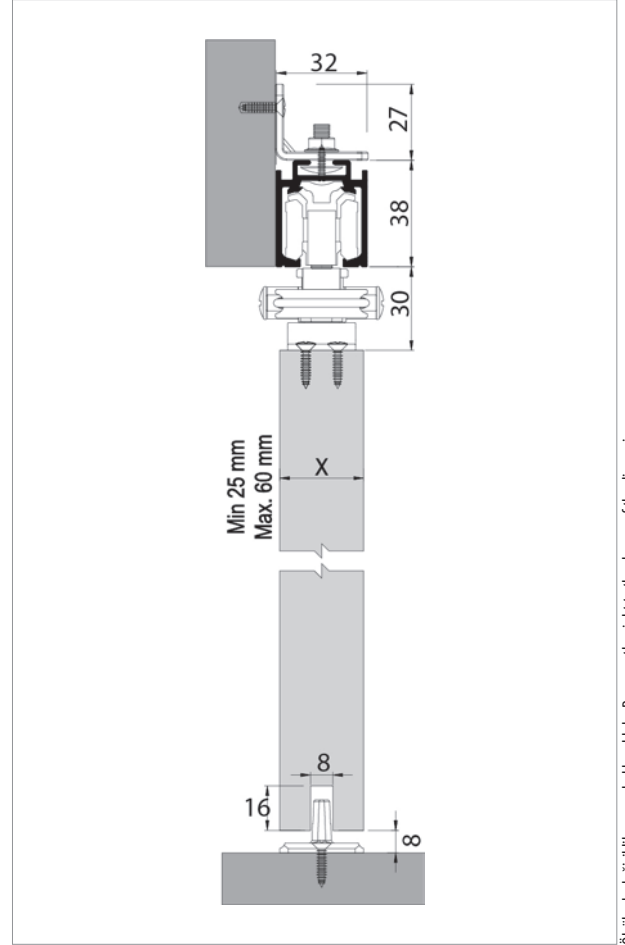

Kod / Code No	Açıklama / Description	Renk / Colour	Birim / Unit			Profil mt. / Profiles mt.	Bağ / Bnd.		
121-9840-1410	40 Kg Yavaşlatıcı Halatlı Sürme Kapı Sistemi / Funicular Sliding Door Has Soft Closing	Gri / Grey	2 Kapı / 1 Set	12	216	-	-	-	
150-9775-1410	Alüminyum Üst Ray Profili / Aluminium Top Rail Profile	Eloksal / Mat Anodized	mt.	-	-	3,0	-	6,0	6 ad/pcs
150-9162-1410	Alüminyum Alt Klavuz Profili / Aluminium Bottom Slider Profile	Eloksal / Mat Anodized	mt.	-	-	3,0	-	-	20 ad/pcs

DoorSync 9850

121-9850

60 KG AYARLI ÇİFT YÖNE YAVAŞLATICILI HALATLI SÜRME KAPI SİSTEMİ
60 KG ADJUSTABLE FUNICULAR SLIDING DOOR SYSTEM - TWO WAY SOFT CLOSING

Özel Üretim
Special Production

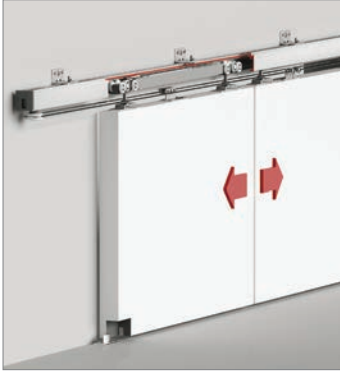

Bilgi / Information

- Minimum kapı genişliği 610 mm olmalıdır.
- Min. Door width 610 mm

Yavaşlatıcı Alternatifi / Soft Closer Alternative

- Sistem üzerinde çift yöne yavaşlatıcı mevcuttur.
- The system has two way soft closing.



121-9850 1 Set İçeriği / 1 Set Includes



Ray Profilleri / Rail Profiles

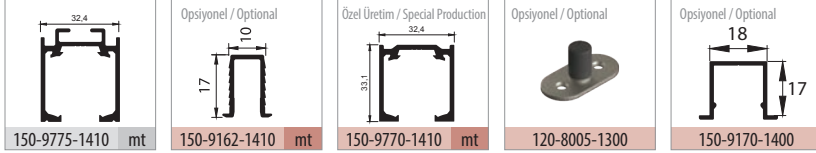

Uygulama / Application



Teknik Detay / Technical Detail

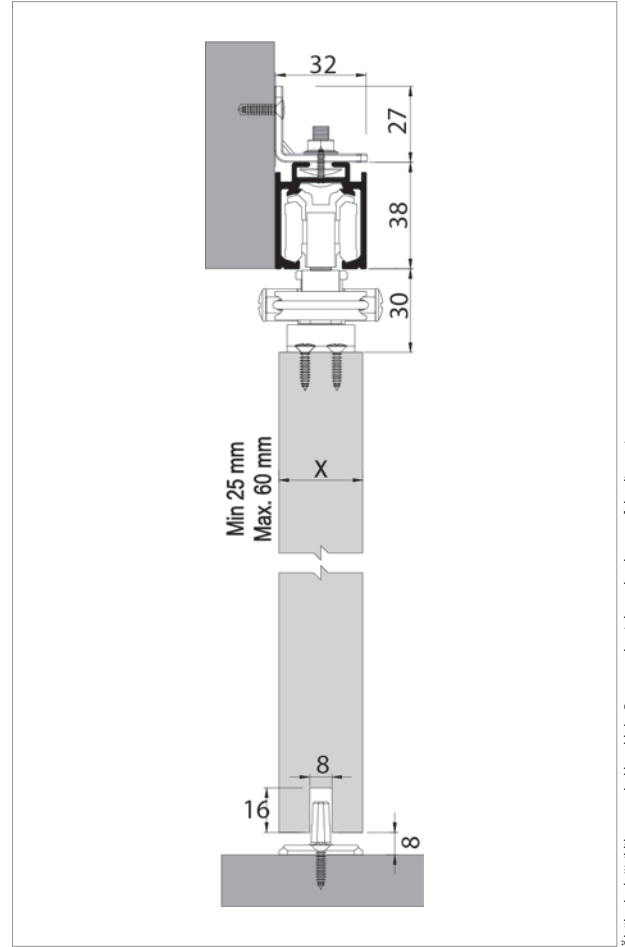

Ölçülerde değişiklik yapma hakkı saklıdır. Reserves the right to the change of the dimensions.

Kod / Code No	Açıklama / Description	Renk / Colour	Birim / Unit			Profil mt. / Profiles mt.	Bağ / Bnd.
121-9850-1410	40 Kg Yavaşlatıcılı Halatlı Sürme Kapı Sistemi / Funicular Sliding Door Has Soft Closing	Gri / Grey	2 Kapı / 1 Set	4	160	-	-
150-9775-1410	Alüminyum Üst Ray Profili / Aluminium Top Rail Profile	Eloksal / Mat Anodized	mt.	-	-	3,0	6,0
150-9162-1410	Alüminyum Alt Klavuz Profili / Aluminium Bottom Slider Profile	Eloksal / Mat Anodized	mt.	-	-	3,0	20 ad/pcs



DoorSync 9820

SINCE 1976	 Bearing Systems	EN 1527 100.000 CYCLES TEST 	 The Sliding System
---------------	---	---	---



DoorSync 9880

121-9880

120 KG AYARLI ÇİFT YÖNE YAVAŞLATICILI HALATLI SÜRME KAPI SİSTEMİ
120 KG ADJUSTABLE FUNICULAR SLIDING DOOR SYSTEM - TWO WAY SOFT CLOSING

Yeni Ürün
New Product

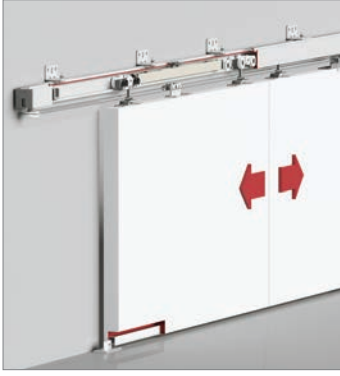

Bilgi / Information

- Minimum kapı genişliği 640 mm olmalıdır.
- Min. Door width 640 mm

Yavaşlatıcı Alternatifi / Soft Closer Alternative

- Sistem üzerinde çift yöne yavaşlatıcı mevcuttur.
- The system has two way soft closing.



121-9880 1 Set İçeriği / 1 Set Includes



Ray Profilleri / Rail Profiles



Teknik Detay / Technical Detail

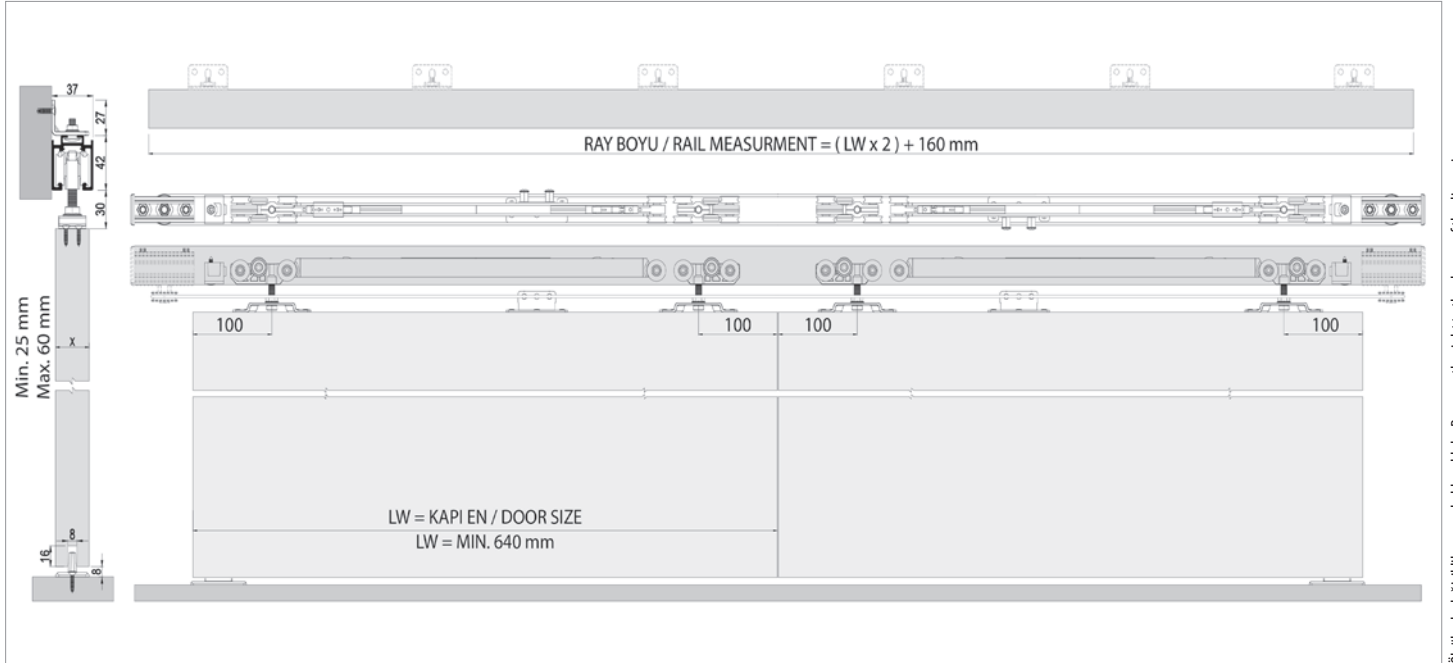

Ölçülerde değişiklik yapma hakkı saklıdır. Reserves the right to the change of the dimensions.

Kod / Code No	Açıklama / Description	Renk / Colour	Birim / Unit			Profil mt. / Profiles mt.	Bağ / Bnd.	
121-9880-1410	DoorSync 9880 - 120 Kg Sürme Kapı Sistemi / Sliding Door System - Soft Closing	Gri / Grey	2 Kapı / 1 Set	4	160	-	-	-
120-8005-1300	Rulmanlı Alt Klavuz Teker / Lower Guide Wheel With Bearing	Gri / Grey	1 Adet / 1 Pcs.	12	576	-	-	-
150-9780-1410	Alüminyum Üst Ray Profili / Aluminium Top Rail Profile	Eloksal / Mat Anodized	mt.	-	-	2,0	3,0	6 ad/pcs
150-9785-1410	Alüminyum Üst Ray Profili / Aluminium Top Rail Profile	Eloksal / Mat Anodized	mt.	-	-	2,0	3,0	6 ad/pcs
150-9162-1410	Alüminyum Alt Klavuz Profili / Aluminium Bottom Slider Profile	Eloksal / Mat Anodized	mt.	-	-	-	3,0	20 ad/pcs
150-9170-1400	Alüminyum Alt Klavuz Profili / Aluminium Bottom Slider Profile	Pres / Uncoated	mt.	-	-	-	3,0	20 ad/pcs

DoorSync 9890

121-9890

120 KG AYARLI ÇİFT YÖNE YAVAŞLATICILI HALATLI SÜRME KAPI SİSTEMİ
120 KG ADJUSTABLE FUNICULAR SLIDING DOOR SYSTEM - TWO WAY SOFT CLOSING

Yeni Ürün
New Product

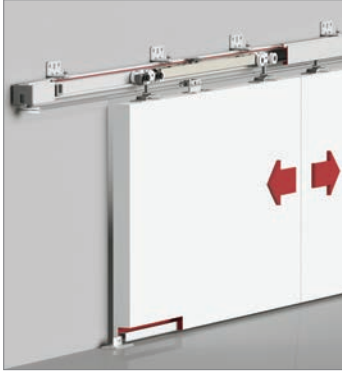

Bilgi / Information

- Minimum kapı genişliği 610 mm olmalıdır.
- Min. Door width 610 mm

Yavaşlatıcı Alternatifi / Soft Closer Alternative

- Sistem üzerinde çift yöne yavaşlatıcı mevcuttur.
- The system has two way soft closing.



121-9890 1 Set İçeriği / 1 Set Includes

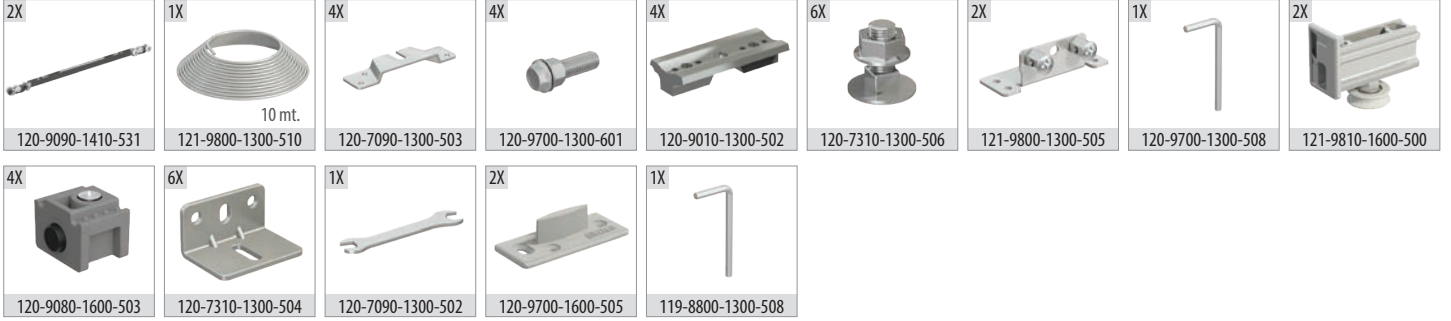

Ray Profilleri / Rail Profiles



Teknik Detay / Technical Detail

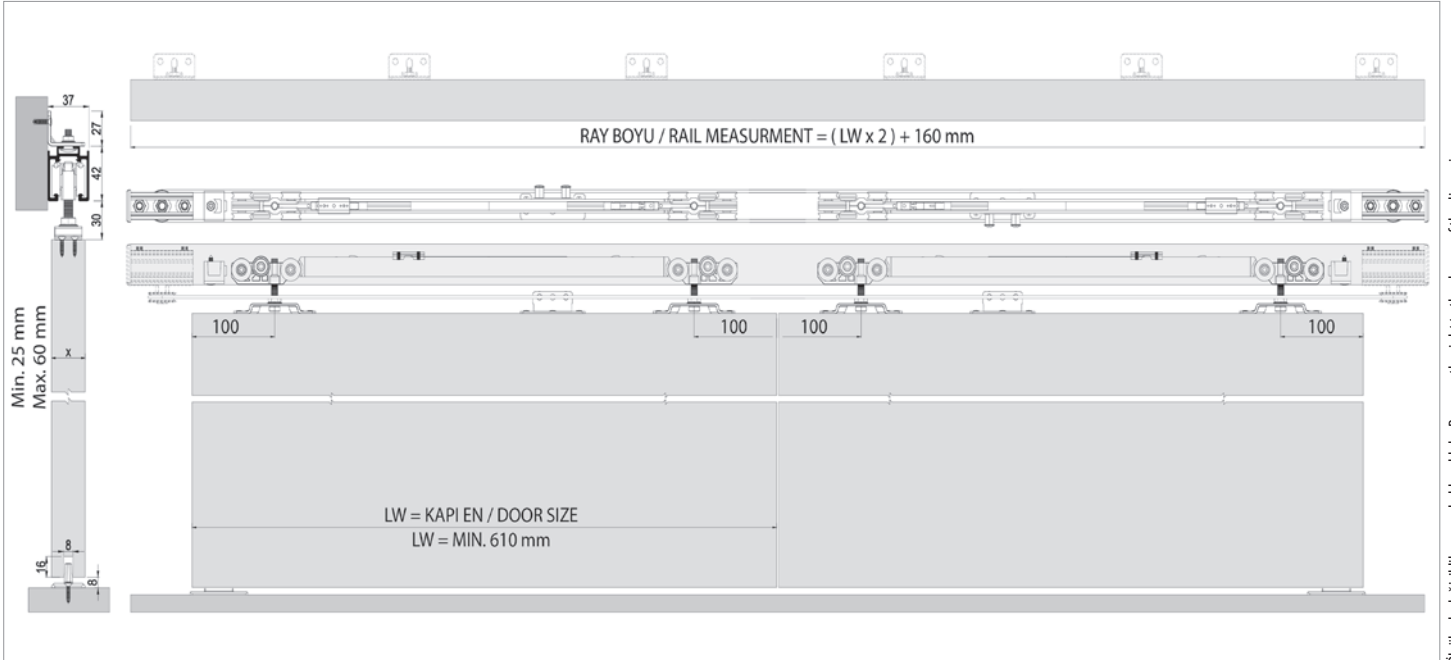

Ölçülerde değişiklik yapma hakkı saklıdır. Reserves the right to the change of the dimensions.

Kod / Code No	Açıklama / Description	Renk / Colour	Birim / Unit			Profil mt. / Profiles mt.	Bağ / Bnd.	
121-9890-1410	DoorSync 9890 - 120 Kg Sürme Kapi Sistemi / Sliding Door System - Soft Closing	Gri / Grey	2 Kapi / 1 Set	4	160	-	-	-
120-8005-1300	Rulmanlı Alt Klavuz Teker / Lower Guide Wheel With Bearing	Gri / Grey	1 Adet / 1 Pcs.	12	576	-	-	-
150-9780-1410	Alüminyum Üst Ray Profili / Aluminium Top Rail Profile	Eloksal / Mat Anodized	mt.	-	-	2,0	3,0	6 ad/pcs
150-9785-1410	Alüminyum Üst Ray Profili / Aluminium Top Rail Profile	Eloksal / Mat Anodized	mt.	-	-	2,0	3,0	6 ad/pcs
150-9162-1410	Alüminyum Alt Klavuz Profili / Aluminium Bottom Slider Profile	Eloksal / Mat Anodized	mt.	-	-	-	3,0	20 ad/pcs
150-9170-1400	Alüminyum Alt Klavuz Profili / Aluminium Bottom Slider Profile	Pres / Uncoated	mt.	-	-	-	3,0	20 ad/pcs

MasterFold[®]

MidFold[®]

Ahşap Katlanır Sürme Kapı Serisi



Wooden Foldable Sliding Door Series



Bu serideki tüm ürünleri incelemek için
QR kodu okutabilirsiniz.

















You can analyze the QR code to see all the
products in these series.



<p>SINCE 1976</p>	 <p>Bearing Systems</p>	<p>EN 1527 100.000 CYCLES TEST</p> 	 <p>The Sliding System</p>
-----------------------	---	--	--

MasterFold 9060



	OEM Kod OEM Code	Ürün Kodu Product Code	Sistem Tipi System Type	Panel Tipi Panel Type	Panel mm	Taşıma Kg Capacity Kg	Video	Üst Ray Upper Rail	Alt Ray Lower Rail	Kapak Adeti Number of Doors
1	131-0090	Domino 90			36 - 44	45	✓			1
2	131-0180	Domino 180			36 - 44	45	✓			1
3	122-9042	MasterFold 9042			36 - 60	40	✓	150-9045	-	-
4	122-9044	MasterFold 9044			36 - 60	40	✓	150-9045	150-9050	-
5	122-9060	MasterFold 9060			36 - 60	60	✓	150-9065	150-9067	-
6	122-9062	MidFold 9062			36 - 60	60	✓	150-9065	150-9067	-
7	122-9300	MasterFold 160			40 - 50	160	✓	150-9450	150-9460	-
8	122-9500	MidFold 160			40 - 50	160	✓	150-9450	150-9460	-
9	122-1050	122-1050	-	-	-	-		-	-	-
10	122-1052	122-1052	-	-	-	-		-	-	-

• Verilen ölçüler bağlayıcı değildir. Önerilen kurulum ölçüleridir. Albatır ürün özelliklerinde haber vermeden değişiklik yapabilir.

• The given dimension are not binding. These are recommended asamble dimensions. Albatır can make alteration to product specification without notice.



131-0090

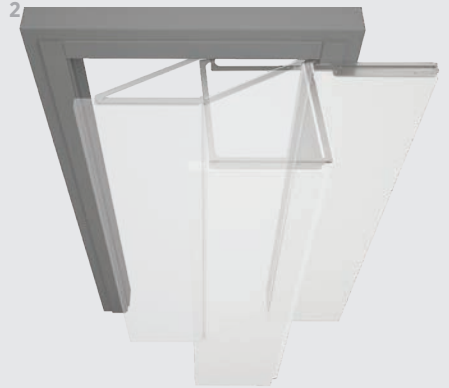

131-0180



122-9042



122-9044



122-9060



122-9062

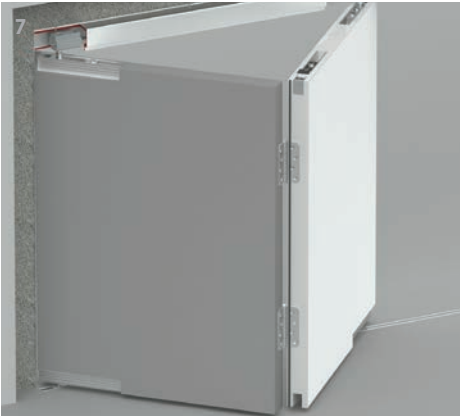

122-9300



122-9500



122-1050



122-1052

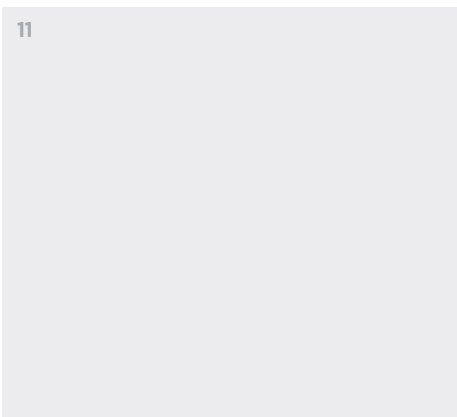

11

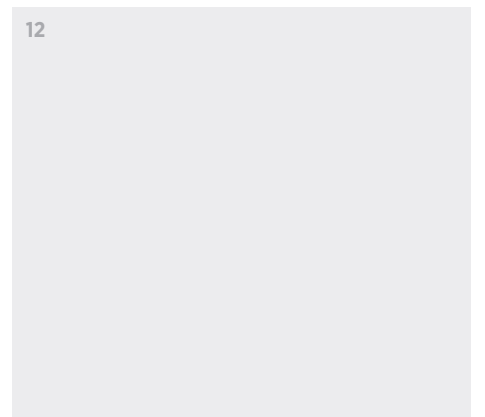

12

Domino 90

122-0090

45 KG 90 DERECE AÇILIR KATLANIR KAPI DONANIMI
45 KG 90 DEGREE BI-FOLDING DOOR HARDWARE

Özel Üretim
Special Production

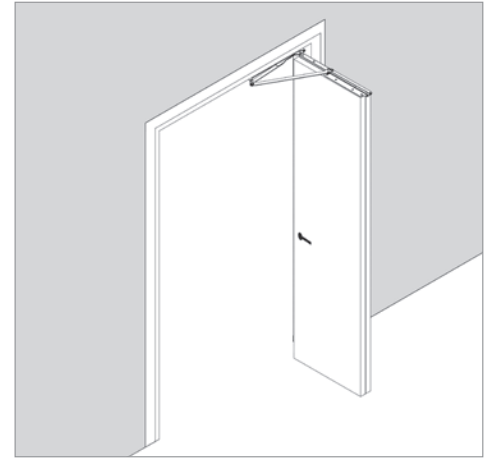
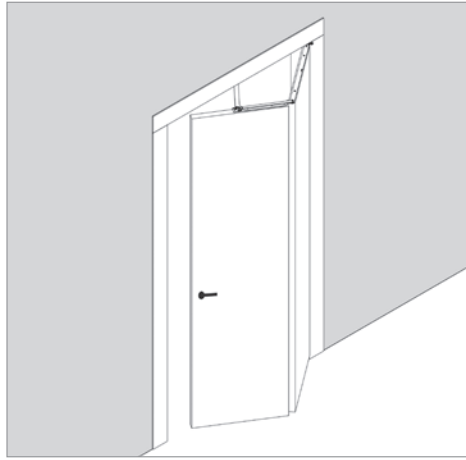
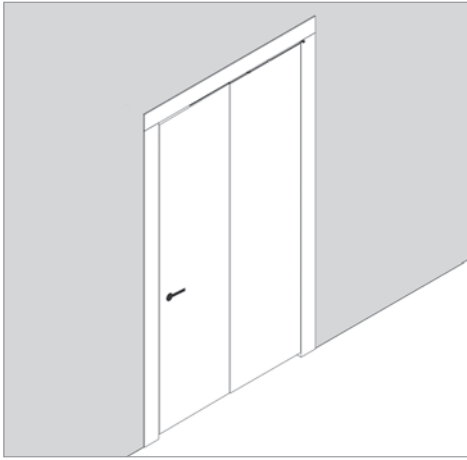

Kod / Code No	Açıklama / Description	Boy / Size	Birim / Unit
122-0090-1820-0600	Domino 90 - Sağ Kapı / Right Door	600 mm	1 Tk. / 1 Set
122-0090-1820-0700	Domino 90 - Sağ Kapı / Right Door	700 mm	1 Tk. / 1 Set
122-0090-1820-0800	Domino 90 - Sağ Kapı / Right Door	800 mm	1 Tk. / 1 Set
122-0090-1820-0900	Domino 90 - Sağ Kapı / Right Door	900 mm	1 Tk. / 1 Set
122-0090-1820-1000	Domino 90 - Sağ Kapı / Right Door	1.000 mm	1 Tk. / 1 Set
122-0095-1820-0600	Domino 90 - Sol Kapı / Left Door	600 mm	1 Tk. / 1 Set
122-0095-1820-0700	Domino 90 - Sol Kapı / Left Door	700 mm	1 Tk. / 1 Set
122-0095-1820-0800	Domino 90 - Sol Kapı / Left Door	800 mm	1 Tk. / 1 Set
122-0095-1820-0900	Domino 90 - Sol Kapı / Left Door	900 mm	1 Tk. / 1 Set
122-0095-1820-1000	Domino 90 - Sol Kapı / Left Door	1.000 mm	1 Tk. / 1 Set

Bilgi / Information

- 90 derece katlanıp park edilebilir kapı makas sistemidir.
- Dar alan bölgelerde kapının açıldığı esnada yerden tasarruf edilmesini sağlar.
- Ahşap kapılar için tasarlanmıştır.
- 36-44 mm ahşap kapılarda kullanıma uygundur.
- Hızlı montaj kiti 40 mm kapılar için kullanılabilir.
- Sistemin toplam taşıma kapasitesi 45 kg dir.
- Kolay ve ahşap kapı üzerinde herhangi bir freze/cnc işlem gerektirmeden montaj edilebilmesi için montaj yatak kiti kullanılarak uygulanabilir özelliğe sahiptir.
- Montaj yatak kiti istenilen renkte boyanarak kapı ile bir bütünlük sağlanabilir.
- Ahşap üzerine işlem yapmadan montaj edilebilir.
- Mekanizma gövdesi paslanmaz malzemeden imal edilmiştir.
- Islak mekanlarda kullanılabilir.
- Farklı kanat açıklıkları için 5 tip ölçüde imal edilmiştir.
- Kapının park ettiği alanın görüleceği içten bakış yönüne göre sağ ve sol mekanizma olarak 2 tip üretimi mevcuttur.
- Estetik görünüm ve sağlıklı çalışma sistemine sahiptir.
- İç mekan kapılarda kullanıma uygundur.
- Kapı üzerine istenilen açma kolu ve/veya tutamak tek yönlü montaj edilebilmektedir.

- It's door scissor system that can be fold and parked 90 degrees.
- It's saves space when opening the door in narrow areas.
- Designed for wooden doors.
- It's available for use on 36-44 mm wooden doors.
- The quick assembly kit can be used for 40 mm
- Total carrying capacity of the system is 45 kg.
- Can also be apply by using the mounting bed kit for easy fixing on the wooden door without any milling cutter /cnc operation.
- The assembly bed kit can be paint in the required color and an integrity with the door can be achieved.
- Can be mounted on wood without processing.
- Mechanism body is made of stainless material.
- Can be used in wet places.
- For the gaps of wing , it's produced in 5 different types of sizes
- There are 2 types of production; as right and left mechanism according to the inside view direction from which the area where the door is parked will be seen.
- It has aesthetic appearance and in well working system
- Available for use on interior doors.
- The required door handle and/or handle can be fixing on the door in one direction.

Domino 180

122-0180

45 KG 180 DERECE AÇILIR KATLANIR KAPI DONANIMI
45 KG 180 DEGREE BI-FOLDING DOOR HARDWARE

Yeni Ürün
New Product

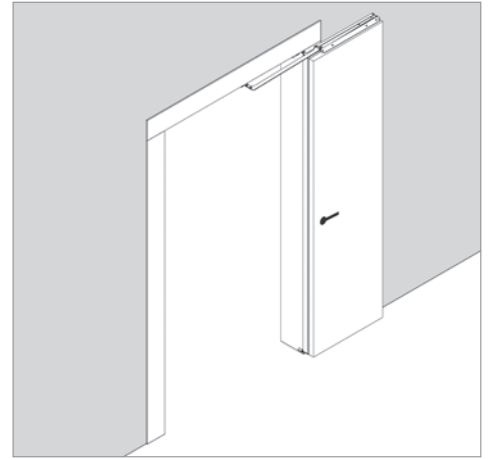
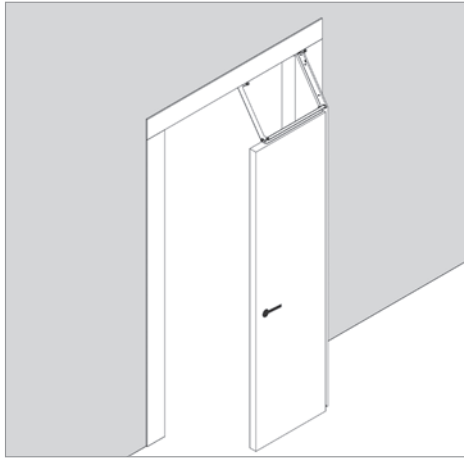
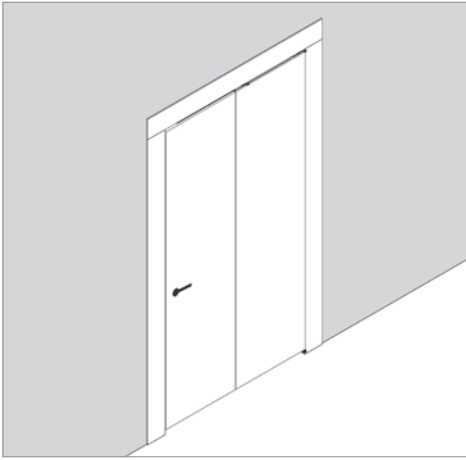

Kod / Code No	Açıklama / Description	Boy / Size	Birim / Unit
122-0180-1820-0600	Domino 180 - Sağ Kapı / Right Door	600 mm	1 Tk. / 1 Set
122-0180-1820-0700	Domino 180 - Sağ Kapı / Right Door	700 mm	1 Tk. / 1 Set
122-0180-1820-0800	Domino 180 - Sağ Kapı / Right Door	800 mm	1 Tk. / 1 Set
122-0180-1820-0900	Domino 180 - Sağ Kapı / Right Door	900 mm	1 Tk. / 1 Set
122-0180-1820-1000	Domino 180 - Sağ Kapı / Right Door	1.000 mm	1 Tk. / 1 Set
122-0185-1820-0600	Domino 180 - Sol Kapı / Left Door	600 mm	1 Tk. / 1 Set
122-0185-1820-0700	Domino 180 - Sol Kapı / Left Door	700 mm	1 Tk. / 1 Set
122-0185-1820-0800	Domino 180 - Sol Kapı / Left Door	800 mm	1 Tk. / 1 Set
122-0185-1820-0900	Domino 180 - Sol Kapı / Left Door	900 mm	1 Tk. / 1 Set
122-0185-1820-1000	Domino 180 - Sol Kapı / Left Door	1.000 mm	1 Tk. / 1 Set

Bilgi / Information

- 180 derece katlanıp park edebilen kapı makas sistemidir.
- Dar alan bölgelerde kapının açıldığı esnada yerden tasarruf edilmesini sağlar.
- Kapı park yönünde, kapı net açıklığının yarısı kadar bir mesafede açılarak net geçiş açıklığının tamamını kullanmanızı sağlar.
- Ahşap kapılar için tasarlanmıştır.
- 36-44 mm ahşap kapılarda kullanıma uygundur.
- Hızlı montaj kiti 40 mm kapılar için kullanılabilir.
- Sistemin toplam taşıma kapasitesi 45 kg dir.
- Gerekli durumlarda gizli menteşe kullanımı ile 3 kanat tek yönde kullanıma uygundur.
- Kolay ve ahşap kapı üzerinde herhangi bir freze/cnc işlem gerektirmeden montaj edilebilmesi için montaj yatak kiti kullanılarak da uygulanabilir özelliğe sahiptir.
- Montaj yatak kiti istenilen renkte boyanarak kapı ile bir bütünlük sağlanabilir.
- Ahşap üzerine işlem yapmadan montaj edilebilir.
- Mekanizma gövdesi paslanmaz malzemeden imal edilmiştir.
- Islak mekanlarda kullanılabilir.
- Farklı kanat açıklıkları için 5 tip ölçüde imal edilmiştir.
- Kapının park ettiği alanın görüleceği içten bakış yönüne göre sağ ve sol mekanizma olarak 2 tip üretimi mevcuttur.
- Estetik görünüm ve sağlıklı çalışma sistemine sahiptir.
- İç mekan kapılarda kullanıma uygundur.
- Kapı üzerine istenilen açma kolu ve/veya tutamak tek yönlü montaj edilebilmektedir.

- It's door scissor system that can be fold and parked 180 degrees.
- It's saves space when opening the door in narrow areas.
- The doors in parking direction, at a distance of half the door clear opening, allowing to use the entire clear passage opening.
- Designed for wooden doors.
- It's available for use on 36-44 mm wooden doors.
- The quick assembly kit can be used for 40 mm doors.
- Total carrying capacity of the system is 45 kg.
- 3 doors are suitable for use in one direction with the use of hidden hinges when its necessary.
- Can also be apply by using the mounting bed kit for easy fixing on the wooden door without any milling cutter /cnc operation.
- The assembly bed kit can be paint in the required color and an integrity with the door can be achieved.
- Can be mounted on wood without processing.
- Mechanism body is made of stainless material.
- Can be used in wet places.
- For the gaps of wing, it's produced in 5 different types of sizes.
- There are 2 types of production; as right and left mechanism according to the inside view direction from which the area where the door is parked will be seen.
- It has aesthetic appearance and in well working system
- Available for use on interior doors.
- The required door handle and/or handle can be fixing on the door in one direction.

MasterFold 9042

122-9042

40 KG AYARLI KATLANIR SÜRME KAPI SİSTEMİ
40 KG ADJUSTABLE FOLDABLE SLIDING DOOR MECHANISM

Yeni Ürün
New Product



Bilgi / Information

- 2 Kapılı mekanizma içermektedir.
- Includes 2 door mechanism.



122-9042 1 Set İçeriği / 1 Set Includes



Ray Profilleri / Rail Profiles

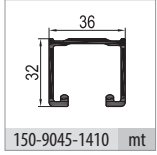

Uygulama / Application



Teknik Detay / Technical Detail

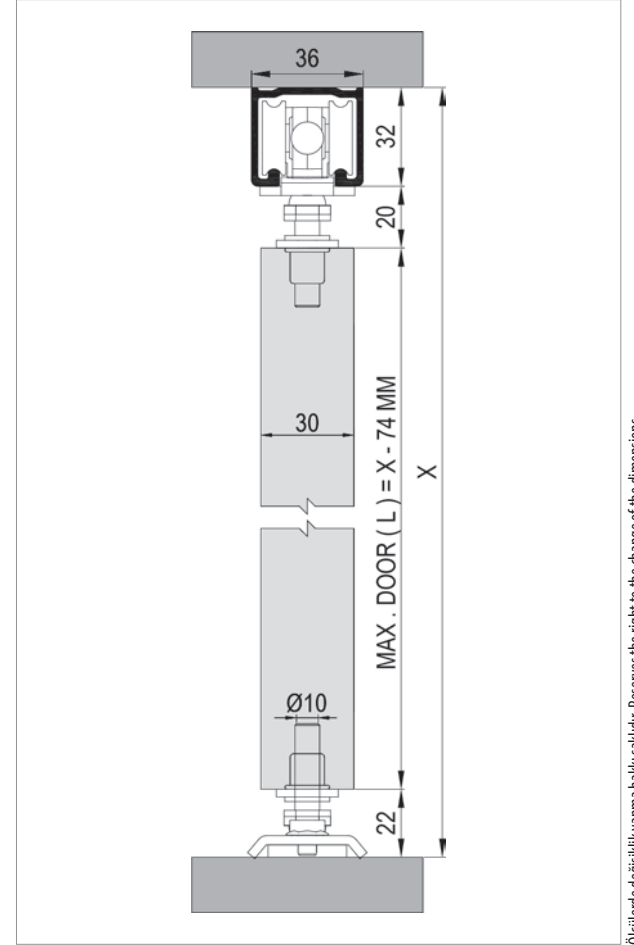

Ölçülerde değişiklik yapma hakkı saklıdır. Reserves the right to the change of the dimensions.

Kod / Code No	Açıklama / Description	Renk / Colour	Birim / Unit			Profil mt. / Profiles mt.	Bağ / Bnd.		
122-9042-1300	40 Kg Katlanır Sürme Kapı Sistemi / Foldable Door Mechanism - Folding Door	Gri / Grey	2 Kapı / 1 Set	12	360	-	-	-	
150-9045-1410	Alüminyum Üst Ray Profili / Aluminium Top Rail Profile	Eloksal / Mat Anodized	mt.	-	-	3,0	-	6,0	2 ad/pcs

MasterFold 9044

122-9044

40 KG AYARLI KATLANIR SÜRME KAPI SİSTEMİ
40 KG ADJUSTABLE FOLDABLE SLIDING DOOR MECHANISM

Yeni Ürün
New Product



Bilgi / Information

- 4 Kapılık mekanizma içermektedir.
- Includes 4 door mechanism.



122-9044 1 Set İçeriği / 1 Set Includes

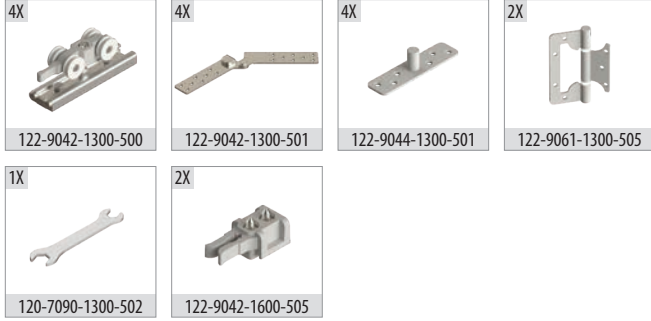

Ray Profilleri / Rail Profiles

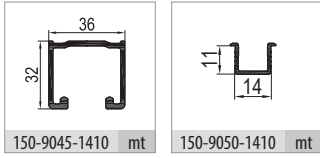

Uygulama / Application



Teknik Detay / Technical Detail

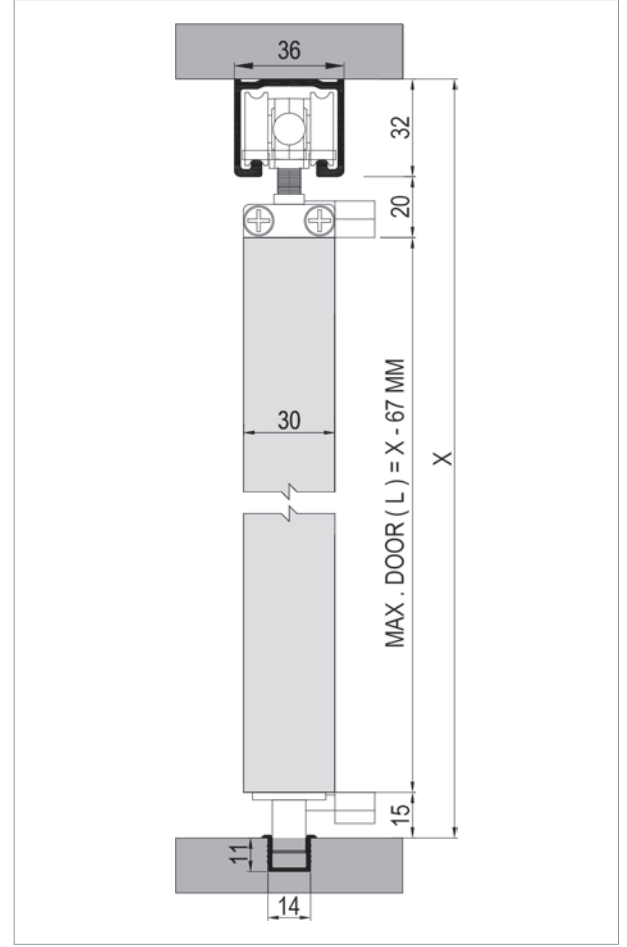

Ölçülerde değişiklik yapma hakkı saklıdır. Reserves the right to the change of the dimensions.

Kod / Code No	Açıklama / Description	Renk / Colour	Birim / Unit			Profil mt. / Profiles mt.	Bağ / Bnd.
122-9044-1300	40 Kg Katlanır Sürme Kapı Sistemi / Foldable Door Mechanism - Folding Door	Gri / Grey	4 Kapı / 1 Set	6	180	-	-
150-9045-1410	Alüminyum Üst Ray Profili / Aluminium Top Rail Profile	Eloksal / Mat Anodized	mt.	-	-	3,0	6,0
150-9050-1410	Alüminyum Alt Klavuz / Aluminium Bottom Slider	Eloksal / Mat Anodized	mt.	-	-	3,0	6,0

MasterFold 9060

122-9060

60 KG AYARLI KATLANIR SÜRME KAPI SİSTEMİ
60 KG ADJUSTABLE FOLDABLE SLIDING DOOR MECHANISM

Yeni Ürün
New Product



Bilgi / Information

- Minimum kapı panel kalınlığı 36 mm. olmalıdır.
- Door panel's thickness should be minimum 36 mm.



122-9060 1 Takım İçeriği / 1 Kit Includes

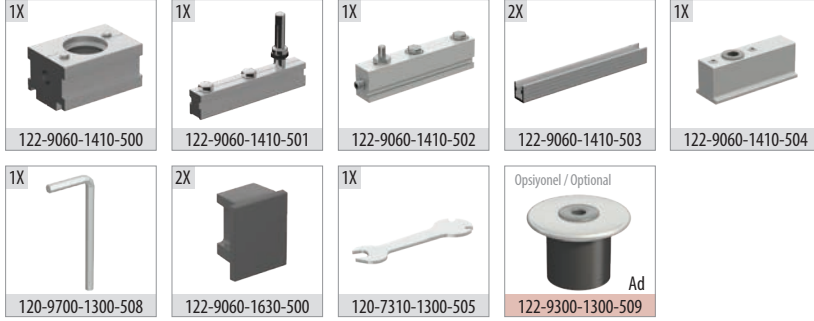

122-9061 1 Takım İçeriği / 1 Kit Includes

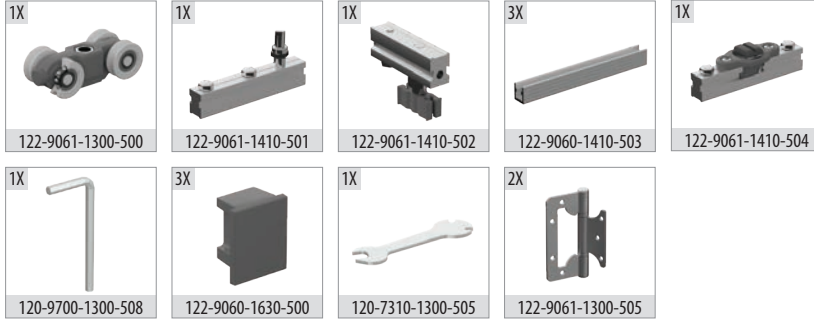

Ray Profilleri / Rail Profiles

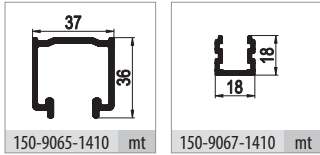

Uygulama / Application



Teknik Detay / Technical Detail

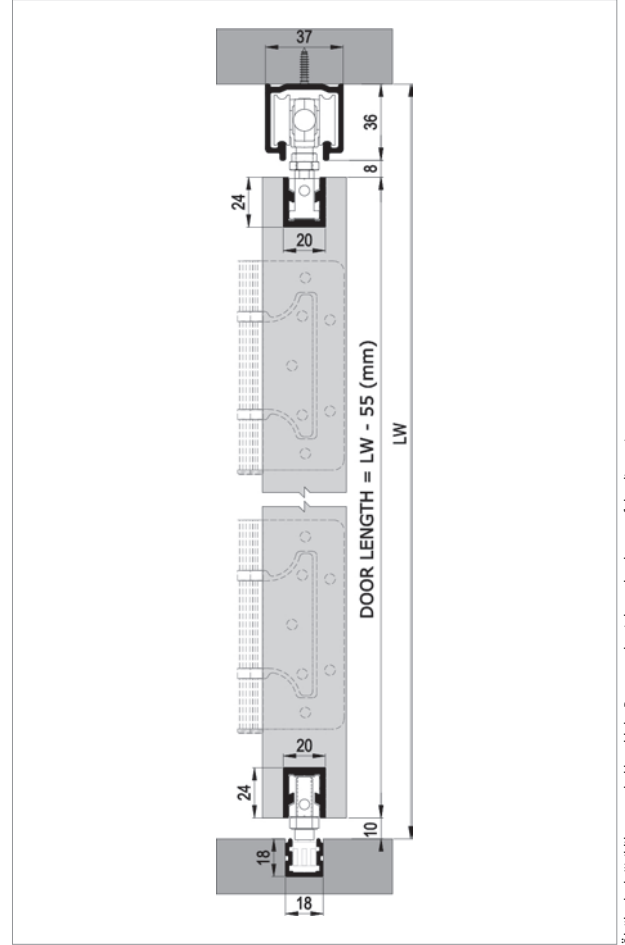

Kod / Code No	Açıklama / Description	Renk / Colour	Birim / Unit			Profil mt. / Profiles mt.	Bağ / Bnd.
122-9060-1410	Masterfold 60 - Sabit Kanat / Foldable Heavy Door System	Gri / Grey	1 Kapı / 1 Kit	16	512	-	-
122-9061-1410	Masterfold 60 -Sürme Katlanır Kapı Sistemi / Sliding Foldable Heavy Door System	Gri / Grey	1 Kapı / 1 Kit	16	512	-	-
122-9061-1300-505	Çelik Menteşe / Steel Hinge	Galvaniz / Galvanized	1 Adet / 1 Pcs	50	2.400	-	-
122-9300-1300-509	Zemin Pivot Burcu Paslanmaz / Ground Pivot Stainless	Galvaniz / Galvanized	1 Adet / 1 Pcs	100	9.600	-	-
150-9065-1410	Alüminyum Üst Ray Profili / Aluminium Top Rail Profile	Eloksal / Mat Anodized	mt.	-	-	-	6,0 6 ad/pcs
150-9067-1410	Alüminyum Alt Klavuz / Aluminium Bottom Slider	Eloksal / Mat Anodized	mt.	-	-	-	6,0 10 ad/pcs

MidFold 9062

122-9062

60 KG AYARLI KATLANIR SÜRME KAPI SİSTEMİ
60 KG ADJUSTABLE FOLDABLE SLIDING DOOR MECHANISM

Yeni Ürün
New Product



Bilgi / Information

- Minimum kapı panel kalınlığı 36 mm. olmalıdır.
- Door panel's thickness should be minimum 36 mm.



122-9060 1 Takım İçeriği / 1 Kit Includes

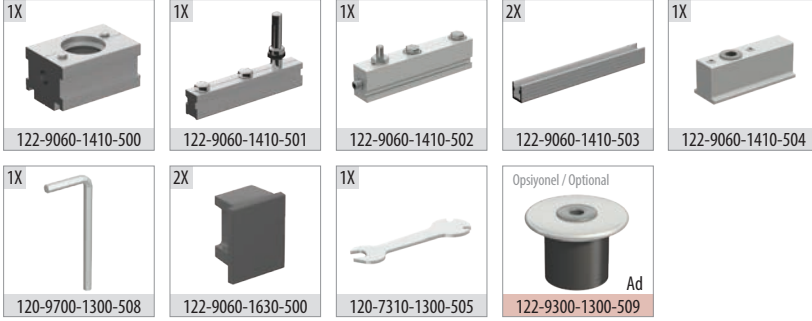

122-9062 1 Takım İçeriği / 1 Kit Includes

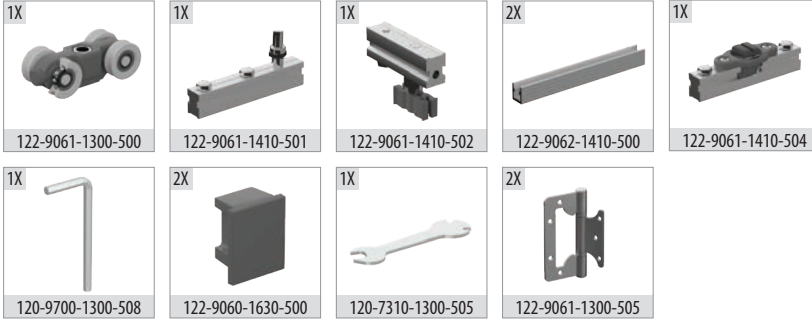

Ray Profilleri / Rail Profiles

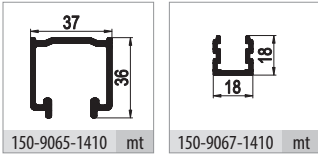

Uygulama / Application



Teknik Detay / Technical Detail

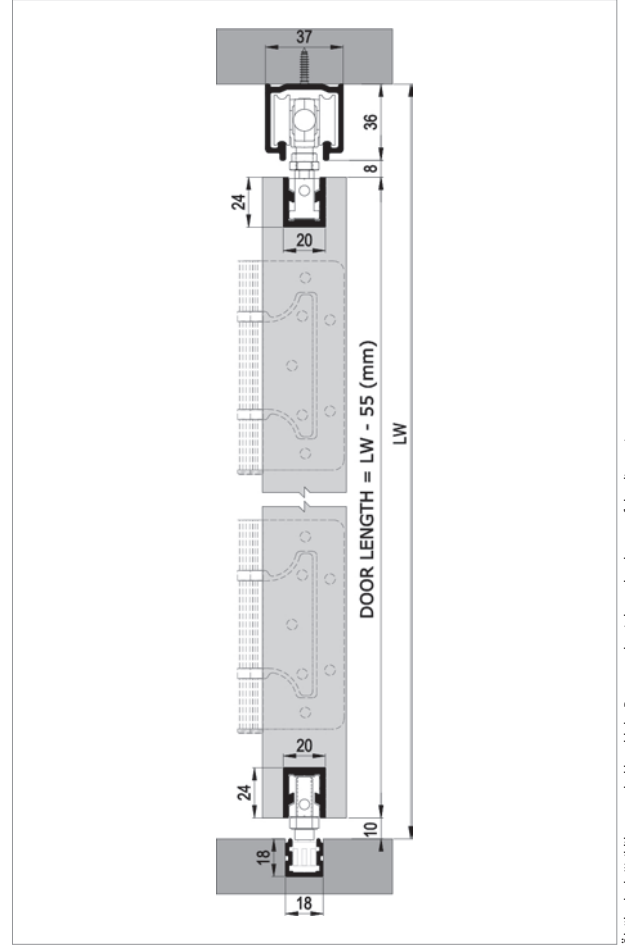

Kod / Code No	Açıklama / Description	Renk / Colour	Birim / Unit			Profil mt. / Profiles mt.	Bağ / Bnd.
122-9060-1410	Masterfold 60 - Sabit Kanat / Foldable Heavy Door System	Gri / Grey	1 Kapı / 1 Kit	16	512	-	-
122-9062-1410	Midfold 60 -Sürme Katlanır Kapı Sistemi / Sliding Foldable Heavy Door System	Gri / Grey	1 Kapı / 1 Kit	4	160	-	-
122-9061-1300-505	Çelik Menteşe / Steel Hinge	Galvaniz / Galvanized	1 Adet / 1 Pcs	50	2.400	-	-
122-9300-1300-509	Zemin Pivot Burcu Paslanmaz / Ground Pivot Stainless	Galvaniz / Galvanized	1 Adet / 1 Pcs	100	9.600	-	-
150-9065-1410	Alüminyum Üst Ray Profili / Aluminium Top Rail Profile	Eloksal / Mat Anodized	mt.	-	-	-	6,0 6 ad/pcs
150-9067-1410	Alüminyum Alt Klavuz / Aluminium Bottom Slider	Eloksal / Mat Anodized	mt.	-	-	-	6,0 10 ad/pcs

MasterFold 160

122-9300

160 KG AYARLI KATLANIR SÜRME KAPI SİSTEMİ
160 KG ADJUSTABLE FOLDABLE SLIDING DOOR MECHANISM



Bilgi / Information

- Minimum kapı panel kalınlığı 40 mm. olmalıdır.
- Door panel's thickness should be minimum 40 mm.



122-9300 1 Takım İçeriği / 1 Kit Includes

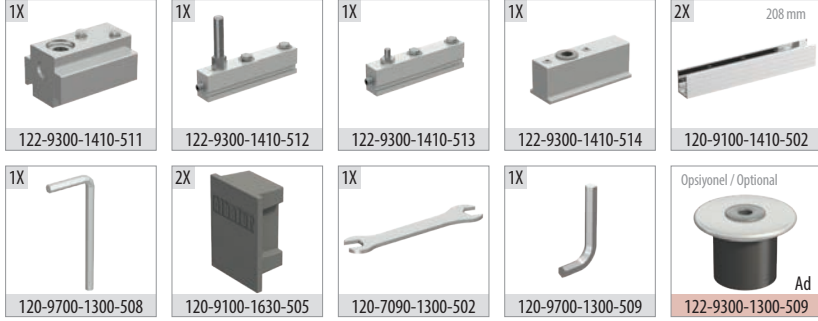

122-9400 1 Takım İçeriği / 1 Kit Includes

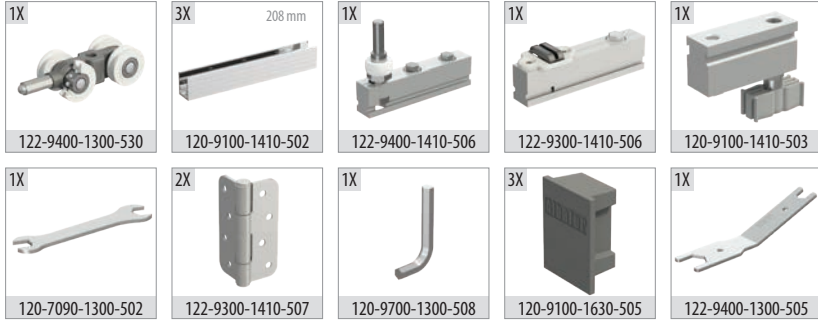

Ray Profilleri / Rail Profiles

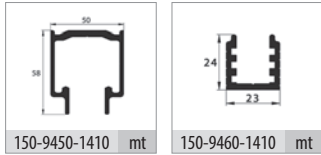

Opsiyonel / Optional

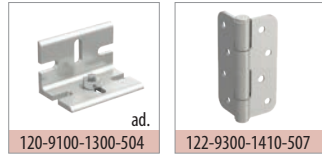

Uygulama / Application



Teknik Detay / Technical Detail

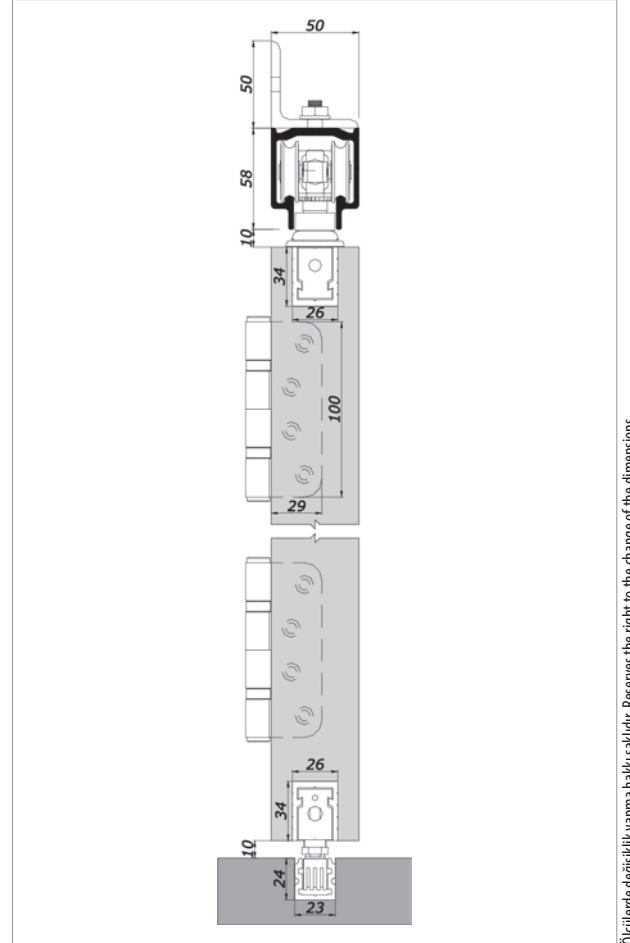

Ölçülerde değişiklik yapma hakkı saklıdır. Reserves the right to the change of the dimensions.

Kod / Code No	Açıklama / Description	Renk / Colour	Birim / Unit			Profil mt. / Profiles mt.			Bağ / Bnd.
122-9300-1410	MasterFold 160 Sabit Kanat / Foldable Heavy Door System	Gri / Grey	1 Kapı / 1 Kit	12	360	-	-	-	-
122-9400-1410	MasterFold 160 Katlanır Kapı Sistemi / Foldable Heavy Door System	Gri / Grey	1 Kapı / 1 Kit	12	360	-	-	-	-
120-9100-1300-504	Aski Aparatı / Hanger Parts	Galvaniz / Galvanized	1 Adet / 1 Pcs	50	2.400	-	-	-	-
122-9300-1300-509	Zemin Pivot Burcu Paslanmaz / Ground Pivot Stainless	Galvaniz / Galvanized	1 Adet / 1 Pcs	100	9.600	-	-	-	-
150-9450-1410	Alüminyum Üst Ray Profili / Aluminium Top Rail Profile	Eloksal / Mat Anodized	mt.	-	-	2,0	3,0	6,0	2 ad/pcs
150-9460-1410	Alüminyum Alt Ray Profili / Aluminium Bottom Rail Profile	Eloksal / Mat Anodized	mt.	-	-	2,0	3,0	6,0	8 ad/pcs

MidFold 160

122-9500

160 KG AYARLI KATLANIR SÜRME KAPI SİSTEMİ
160 KG ADJUSTABLE FOLDABLE SLIDING DOOR MECHANISM



Bilgi / Information

- Minimum kapı panel kalınlığı 40 mm. olmalıdır.
- Door panel's thickness should be minimum 40 mm.



122-9300 1 Takım İçeriği / 1 Kit Includes

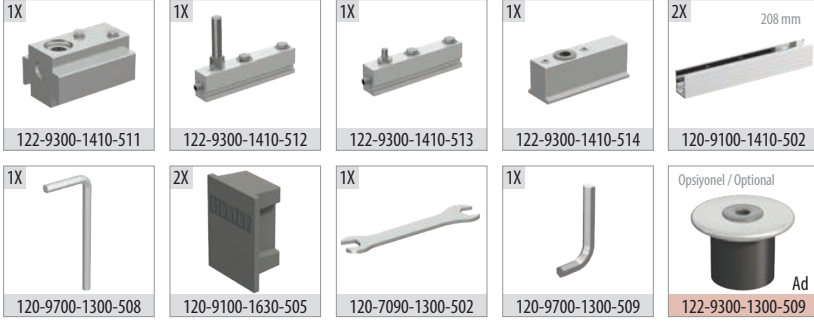

122-9500 1 Takım İçeriği / 1 Kit Includes

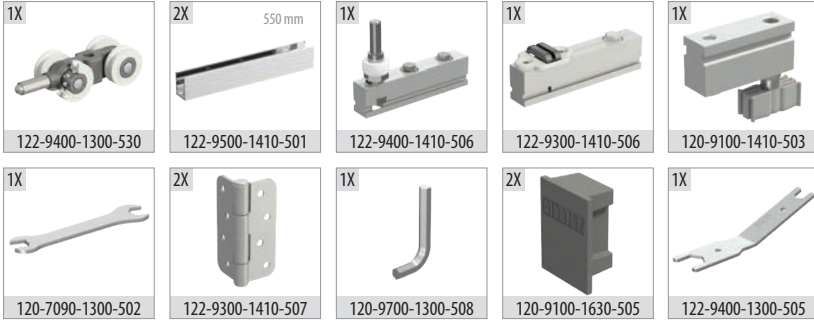

Ray Profilleri / Rail Profiles

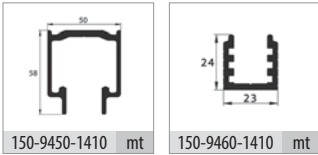

Opsiyonel / Optional

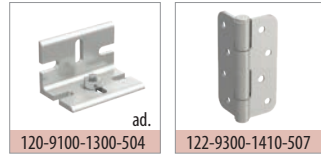

Uygulama / Application



Teknik Detay / Technical Detail

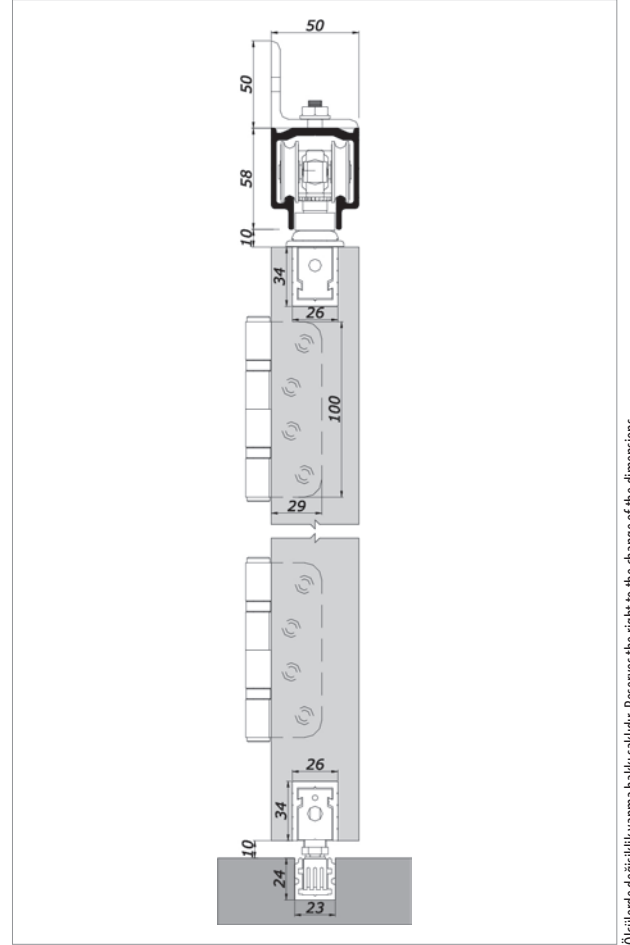

Ölçülerde değişiklik yapma hakkı saklıdır. Reserves the right to the change of the dimensions.

Kod / Code No	Açıklama / Description	Renk / Colour	Birim / Unit			Profil mt. / Profiles mt.			Bağ / Bnd.
122-9300-1410	MasterFold 160 Sabit Kanat / Foldable Heavy Door System	Gri / Grey	1 Kapı / 1 Kit	12	360	-	-	-	-
122-9500-1410	MidFold 160 Katlanır Kapı Sistemi / Foldable Heavy Door System	Gri / Grey	1 Kapı / 1 Kit	4	160	-	-	-	-
120-9100-1300-504	Askı Aparatı / Hanger Parts	Galvaniz / Galvanized	1 Adet / 1 Pcs	50	2.400	-	-	-	-
122-9300-1300-509	Zemin Pivot Burcu Paslanmaz / Ground Pivot Stainless	Galvaniz / Galvanized	1 Adet / 1 Pcs	100	9.600	-	-	-	-
150-9450-1410	Alüminyum Üst Ray Profili / Aluminium Top Rail Profile	Eloksal / Mat Anodized	mt.	-	-	2,0	3,0	6,0	2 ad/pcs
150-9460-1410	Alüminyum Alt Ray Profili / Aluminium Bottom Rail Profile	Eloksal / Mat Anodized	mt.	-	-	2,0	3,0	6,0	8 ad/pcs



1 Set İçeriği / 1 Set Includes

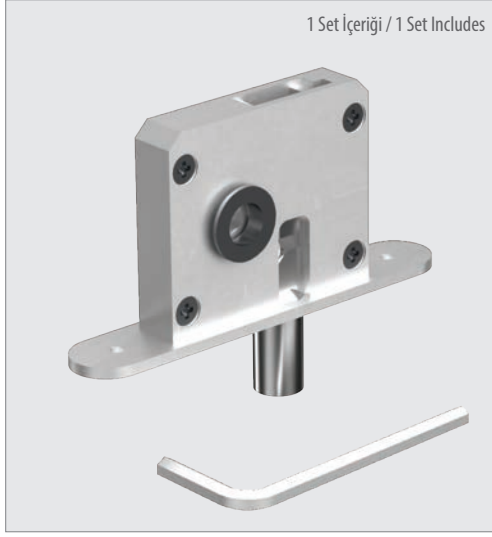

Bilgi / Information

- Katlanır kapı sistemleri için üretilmiş kilit mekanizmasıdır.
- Lock mechanism for folding door systems.

Teknik Detay / Technical Detail

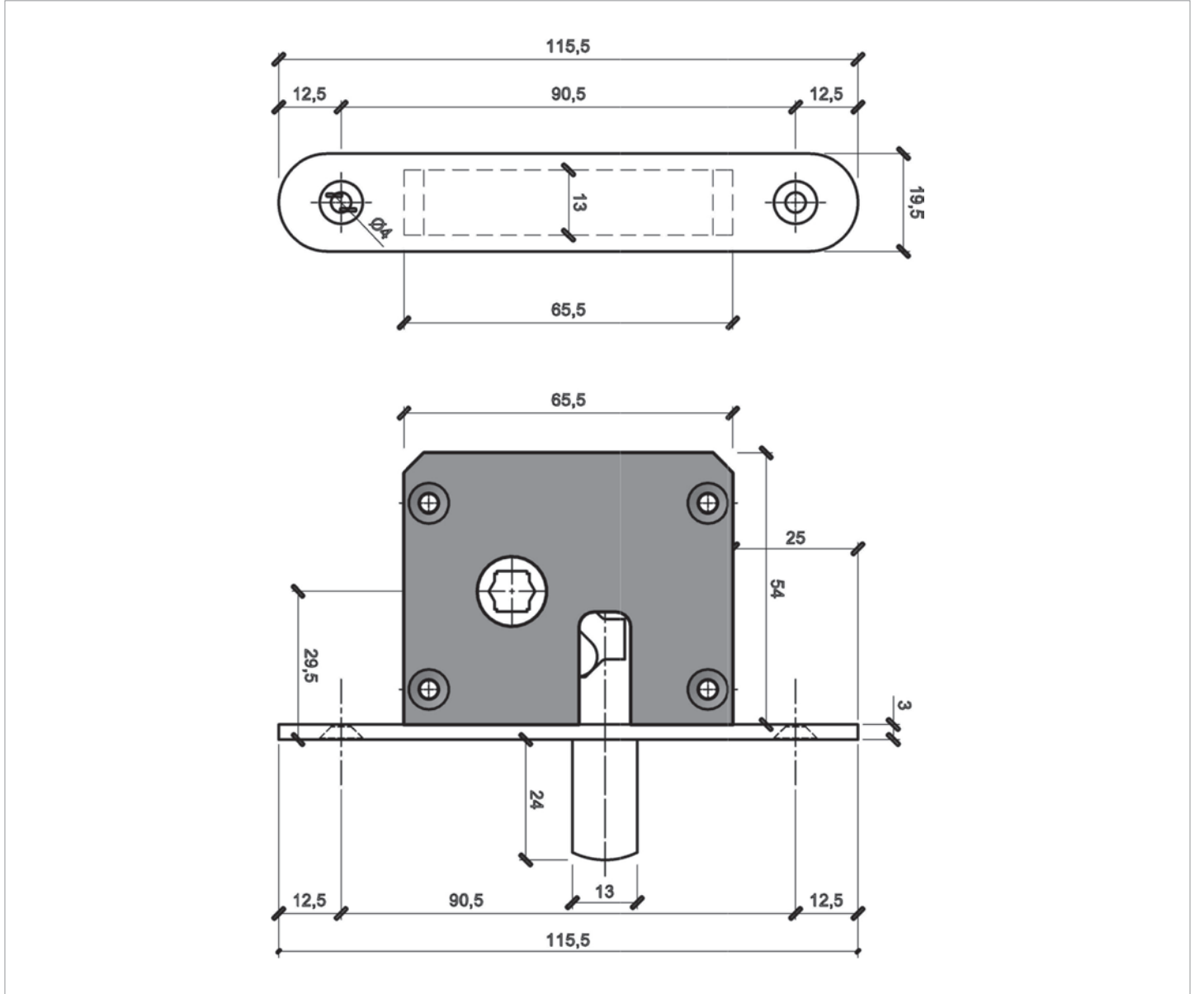

Kod / Code No	Açıklama / Description	Renk / Colour	Birim / Unit		
122-1050-1800	Katlanır Kapı Kilit Mekanizması • Folding Door Lock Mechanism	Galvaniz / Galvanized	1 Adet / 1 Pcs	-	-

1 Set İçeriği / 1 Set Includes



Bilgi / Information







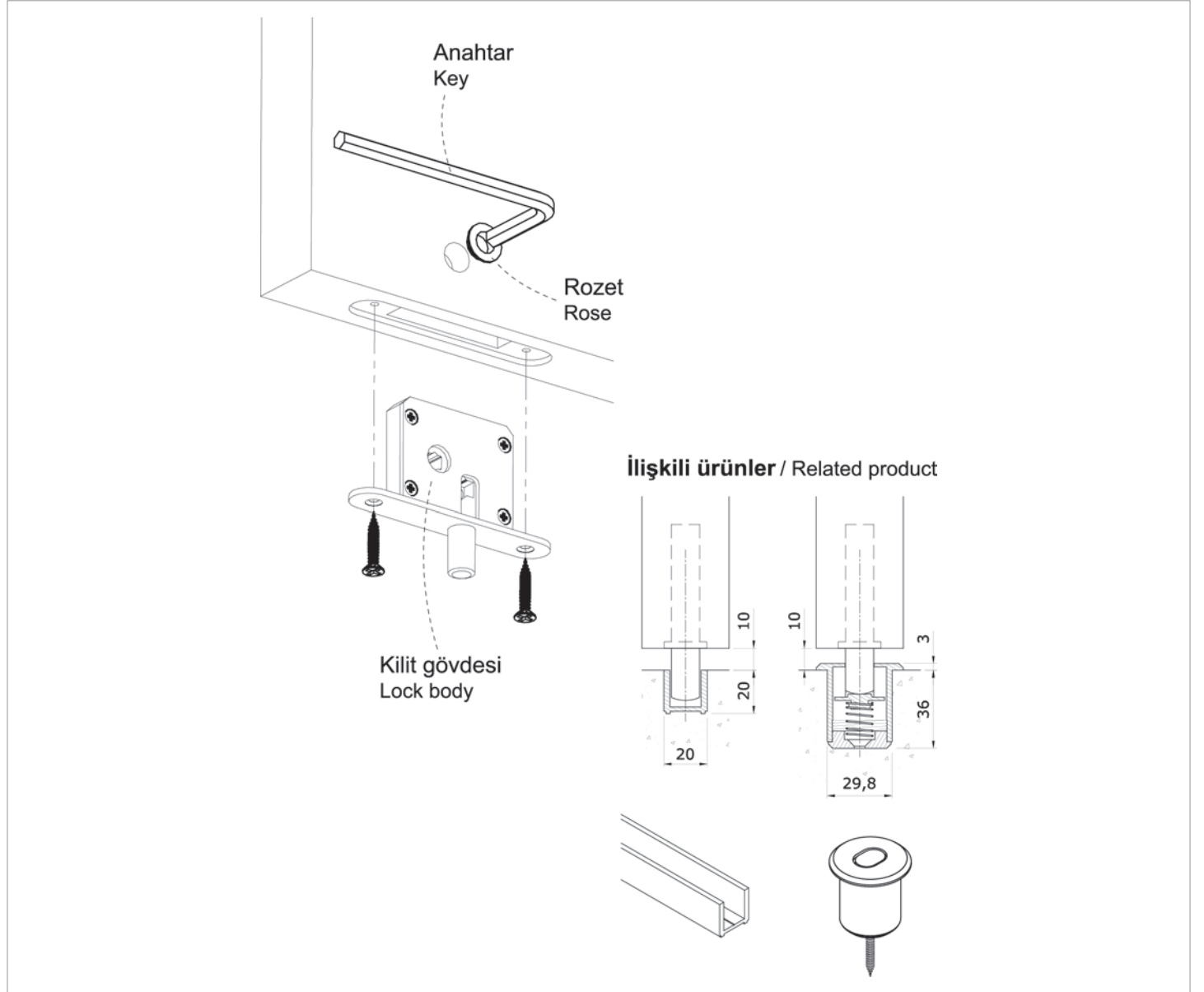







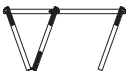





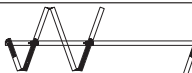









- Katlanır kapı sistemleri için üretilmiş kilit mekanizmasıdır.
- Lock mechanism for folding door systems.

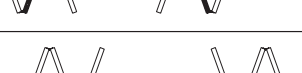
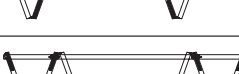

Teknik Detay / Technical Detail

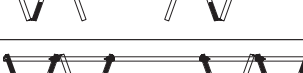
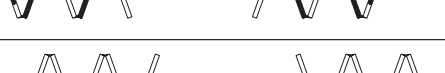













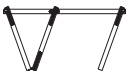





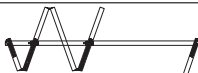









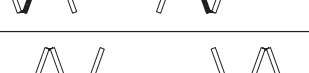
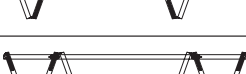

Kod / Code No	Açıklama / Description	Renk / Colour	Birim / Unit		
122-1052-1820	Yer Soketi • Dust Proof Strike	Galvaniz / Galvanized	1 Adet / 1 Pcs	-	-

	9060 - 1 Tk 9061 - 1 Tk		9060 - 1 Tk 9062 - 1 Tk
	9060 - 1 Tk 9061 - 1 Tk		9060 - 2 Tk 9062 - 1 Tk
	9060 - 2 Tk 9061 - 1 Tk		9060 - 1 Tk 9062 - 1 Tk
	9060 - 2 Tk 9061 - 1 Tk		9060 - 2 Tk 9062 - 1 Tk
	9060 - 1 Tk 9061 - 2 Tk		9060 - 1 Tk 9062 - 2 Tk
	9060 - 1 Tk 9061 - 2 Tk		9060 - 2 Tk 9062 - 2 Tk
	9060 - 2 Tk 9061 - 2 Tk		9060 - 1 Tk 9062 - 3 Tk
	9060 - 1 Tk 9061 - 3 Tk		9060 - 2 Tk 9062 - 2 Tk
	9060 - 2 Tk 9061 - 2 Tk		9060 - 1 Tk 9062 - 3 Tk
	9060 - 1 Tk 9061 - 3 Tk		9060 - 2 Tk 9062 - 3 Tk
	9060 - 2 Tk 9061 - 3 Tk		9060 - 2 Tk 9062 - 2 Tk
	9060 - 2 Tk 9061 - 3 Tk		9060 - 2 Tk 9062 - 2 Tk
	9060 - 2 Tk 9061 - 2 Tk		9060 - 2 Tk 9062 - 4 Tk
	9060 - 2 Tk 9061 - 2 Tk		9060 - 2 Tk 9062 - 4 Tk
	9060 - 2 Tk 9061 - 4 Tk		9060 - 2 Tk 9062 - 6 Tk
	9060 - 2 Tk 9061 - 4 Tk		9060 - 2 Tk 9062 - 6 Tk
	9060 - 2 Tk 9061 - 6 Tk		
	9060 - 2 Tk 9061 - 6 Tk		

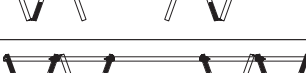
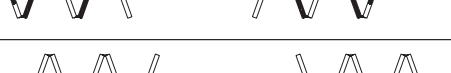
- Yüksekliği 2.100 mm olan kanatlarda, kapı başına 2 adet menteşe kullanılmalıdır.
- Yüksekliği 2.100 - 2.500 mm'ye kadar kanatlarda, kapı başına 3 adet menteşe kullanılmalıdır.
- Yüksekliği 2.500 - 2.700 mm'ye kadar kanatlarda, kapı başına 4 adet menteşe önerilir.
- Minimum kapı genişliği 380 mm olmalıdır.
- Maksimum kapı genişliği 900 mm olmalıdır.
- Minimum ahşap kapı panel kalınlığı 36 mm olmalıdır.
- Alüminyum Profil kanatlarda min. kapı panel kalınlığı 25 mm olmalıdır.
- Maksimum yükseklik 2.700 mm olmalıdır.
- Montaj esnasında uygulamaya göre ilave menteşe talep edilebilir.

- 2.100 mm in height for doors, should be used 2 pcs hinge per door.
- Up to 2.100 - 2.500 mm in height for doors, 3 hinges should be used per door.
- Up to 2.500 - 2.700 mm in height for doors, 4 hinges should be used per door.
- Min. door width 380 mm
- Max. door width 900 mm
- Door panel's thickness should be min. 36 mm
- The minimum thickness should be 25mm on aluminum profile panel doors.
- Max. door hight 2.700 mm
- An additional hinge steel hinge can be requested during the assembly.

	9300 - 1 Tk. 9400 - 1 Tk.		9300 - 1 Tk. 9500 - 1 Tk.
	9300 - 1 Tk. 9400 - 1 Tk.		9300 - 2 Tk. 9500 - 1 Tk.
	9300 - 2 Tk. 9400 - 1 Tk.		9300 - 1 Tk. 9500 - 1 Tk.
	9300 - 2 Tk. 9400 - 1 Tk.		9300 - 2 Tk. 9500 - 1 Tk.
	9300 - 1 Tk. 9400 - 2 Tk.		9300 - 1 Tk. 9500 - 2 Tk.
	9300 - 1 Tk. 9400 - 2 Tk.		9300 - 2 Tk. 9500 - 2 Tk.
	9300 - 2 Tk. 9400 - 2 Tk.		9300 - 1 Tk. 9500 - 3 Tk.
	9300 - 1 Tk. 9400 - 3 Tk.		9300 - 2 Tk. 9500 - 2 Tk.
	9300 - 2 Tk. 9400 - 2 Tk.		9300 - 1 Tk. 9500 - 3 Tk.
	9300 - 1 Tk. 9400 - 3 Tk.		9300 - 2 Tk. 9500 - 3 Tk.
	9300 - 2 Tk. 9400 - 3 Tk.		9300 - 2 Tk. 9500 - 2 Tk.
	9300 - 2 Tk. 9400 - 3 Tk.		9300 - 2 Tk. 9500 - 2 Tk.
	9300 - 2 Tk. 9400 - 2 Tk.		9300 - 2 Tk. 9500 - 4 Tk.
	9300 - 2 Tk. 9400 - 2 Tk.		9300 - 2 Tk. 9500 - 4 Tk.
	9300 - 2 Tk. 9400 - 4 Tk.		9300 - 2 Tk. 9500 - 6 Tk.
	9300 - 2 Tk. 9400 - 4 Tk.		9300 - 2 Tk. 9500 - 6 Tk.
	9300 - 2 Tk. 9400 - 6 Tk.		
	9300 - 2 Tk. 9400 - 6 Tk.		

* Yüksekliği 2500 mm olan kanatlarda, kapı başına 2 adet 122-9300-1410-507 kullanılmalıdır.

* Yüksekliği 2500 mm'den büyük kanatlarda, kapı başına 3 adet 122-9300-1410-507 kullanılmalıdır.

* Minimum kapı genişliği 550 mm olmalıdır.

* Maksimum kapı genişliği 950 mm olmalıdır.

* Minimum kapı panel kalınlığı 40 mm olmalıdır.

* Maksimum yükseklik 2.700 mm olmalıdır.

* Montaj esnasında uygulamaya göre ilave 122-9300-1410-507 menteşe talep edilebilir.

* 2500 mm in height for doors, should be used 2 pcs 122-9300-1410-507 per door

* More than height 2500 mm for doors, should be used 3 pcs 122-9300-1410-507 per door

* Min. door width 550 mm

* Max. door width 950 mm



* Door panel's thickness should be min. 40 mm

* Max. door height 2.700 mm

* An additional 122-9300-1410-507 steel hinge can be requested during the assembly.





MasterFold 160

<p>SINCE 1976</p>	 <p>Bearing Systems</p>	<p>EN 1527 100.000 CYCLES TEST</p> 	<p>R</p> <p>The Sliding System</p>
-----------------------	---	--	---





MidFold 160

<p>SINCE 1976</p>	 <p>Bearing Systems</p>	<p>EN 1527 100.000 CYCLES TEST</p> 	<p>R</p> <p>The Sliding System</p>
-----------------------	---	--	---



Group 123

GlassDoor[®]

Cam Sürme Kapı Serisi

Glass Door Sliding Series



Bu serideki tüm ürünleri incelemek için
QR kodu okutabilirsiniz.

You can analyze the QR code to see all the
products in these series.



GlassDoor 9920

SINCE 1976

Bearing Systems

EN 1527
100.000
CYCLES
TEST

R
The Sliding System



	OEM Kod OEM Code	Ürün Kodu Product Code	Sistem Tipi System Type	Panel Tipi Panel Type	Fren Yönü Brake Direc.	Panel mm	Taşıma Kg Capacity Kg	Video	Üst Ray Upper Rail	Alt Ray Lower Rail	Kapak Adeti Number of Doors	Yavaşlatıcı Dahil Soft Closer Including	Min. Kapak Genişlik mm Min. Cover Width mm
1	123-9906	GlassDoor 9906				8 - 12	60	✓	150-7006	-	1	✓	580
2	123-9912	GlassDoor 9912				8 - 12	120	✓	150-7012	-	1	✓	500
3	123-9910	GlassDoor 9910				8 - 12	80		150-7244	-	1		-
4	123-9911	GlassDoor 9911				8 - 12	80		150-7244	-	1		-
5	123-9900	GlassDoor 9900				8 - 12	120		150-9750	-	1		-
6	123-9901	GlassDoor 9901				8 - 12	120		150-9750	-	1		-
7	123-9930	GlassDoor 9930				8 - 12	60	✓					
8	123-9935	GlassDoor 9935				8 - 12	60	✓					
9	123-9902	GlassDoor 9902				8 - 12	120	✓	150-9750	-	1	✓	600
10	123-9903	GlassDoor 9903				8 - 12	120	✓	150-9750	-	1	✓	600
11	123-9920	GlassDoor 9920				8 - 12	120	✓	150-9750	-	1	✓	900
12	123-9921	GlassDoor 9921				8 - 12	120	✓	150-9750	-	1	✓	900

- Verilen ölçüler bağlayıcı değildir. Önerilen kurulum ölçüleridir. Albatür ürün özelliklerinde haber vermeden değişiklik yapabilir.
- The given dimension are not binding. These are recommended assemble dimensions. Albatür can make alteration to product specification without notice.



123-9030

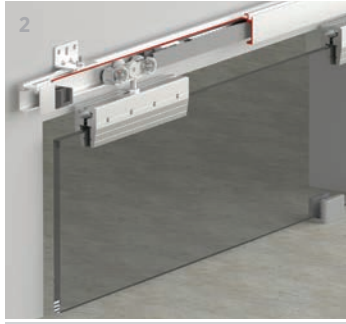

123-9035

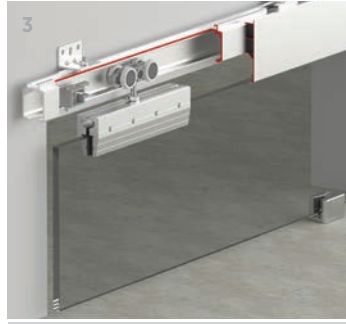

123-9900



123-9901

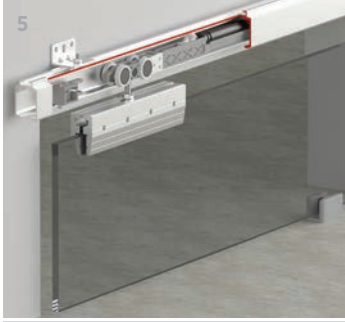

123-9902



123-9903



123-9906



123-9910



123-9911

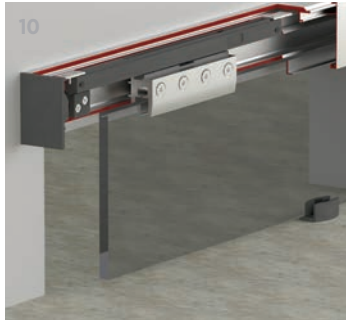

123-9912

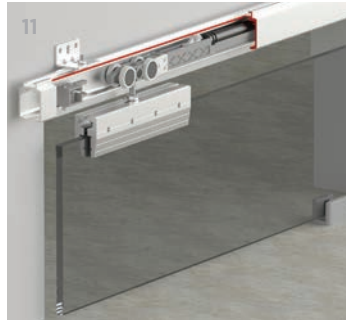

123-9920



123-9921



123-9980



123-9985

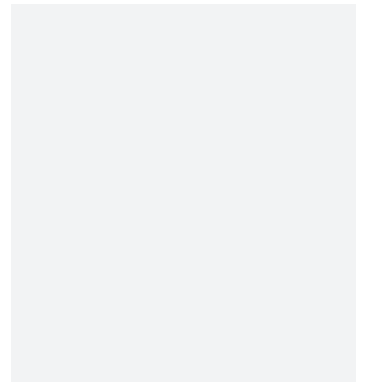
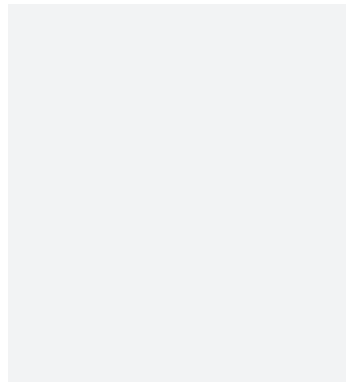
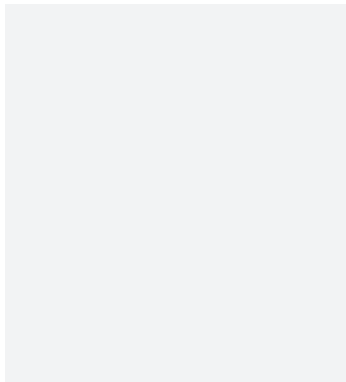
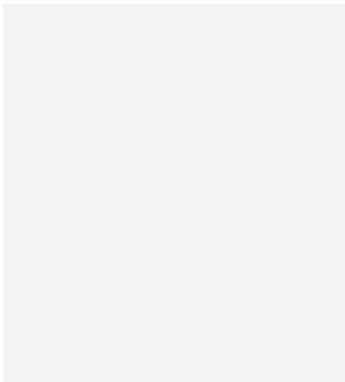

GlassDoor 9906

123-9906

60 KG AYARLI ÇİFT YÖNE YAVAŞLATICILI SÜRME CAM KAPI SİSTEMİ
60 KG ADJUSTABLE SLIDING GLASS DOOR SYSTEM - TWO WAY SOFT CLOSING

Yeni Ürün
New Product

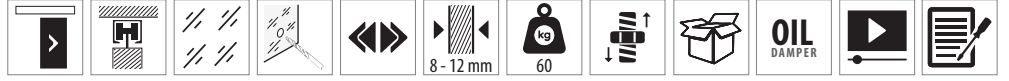

Bilgi / Information

- Minimum kapı genişliği 580 mm olmalıdır.
- Min. Door width 580 mm

Yavaşlatıcı Alternatifi / Soft Closer Alternative

- Sistem üzerinde çift yöne yavaşlatıcı mevcuttur.
- The system has two way soft closing.



123-9906 1 Takım İçeriği / 1 Kit Includes

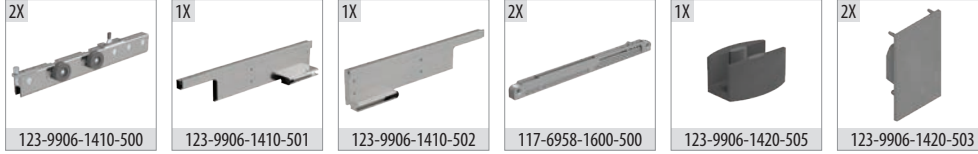

Ray Profilleri / Rail Profiles

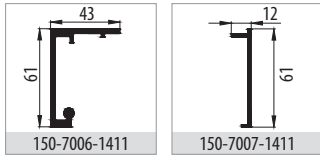



Teknik Detay / Technical Detail



Uygulama / Application



Kod / Code No	Açıklama / Description	Renk / Colour	Birim / Unit			Profil mt. / Profiles mt.			Bağ / Bnd.
123-9906-1410	60 Kg Yavaşlatıcılı Sürme Cam Kapı Sistemi / Sliding Glass Door System	Gri / Grey	1 Kapı / 1 Kit	4	192	-	-	-	-
150-7006-1411	Alüminyum Üst Ray Profili / Aluminium Top Rail Profile	Eloksal / Mat Anodized	mt.	-	-	2,0	3,0	-	6 ad/pcs
150-7007-1411	Alüminyum Alın Kapama Profili / Aluminum Covering Profile	Eloksal / Mat Anodized	mt.	-	-	2,0	3,0	-	6 ad/pcs

Ölçülerde değişiklik yapma hakkı saklıdır. Reserves the right to the change of the dimensions.

GlassDoor 9912

123-9912

120 KG AYARLI ÇİFT YÖNE YAVAŞLATICILI SÜRME CAM KAPI SİSTEMİ
120 KG ADJUSTABLE SLIDING GLASS DOOR SYSTEM - TWO WAY SOFT CLOSING

Yeni Ürün
New Product

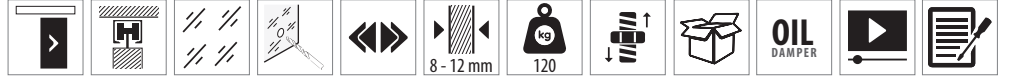

Bilgi / Information

- Minimum kapı genişliği 500 mm olmalıdır.
- Min. Door width 500 mm

Yavaşlatıcı Alternatifi / Soft Closer Alternative

- Sistem üzerinde çift yöne yavaşlatıcı mevcuttur.
- The system has two way soft closing.



123-9912 1 Takım İçeriği / 1 Kit Includes

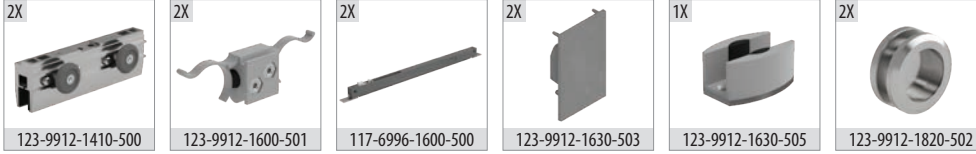

Ray Profilleri / Rail Profiles

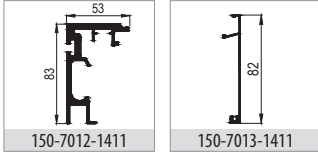

Teknik Detay / Technical Detail

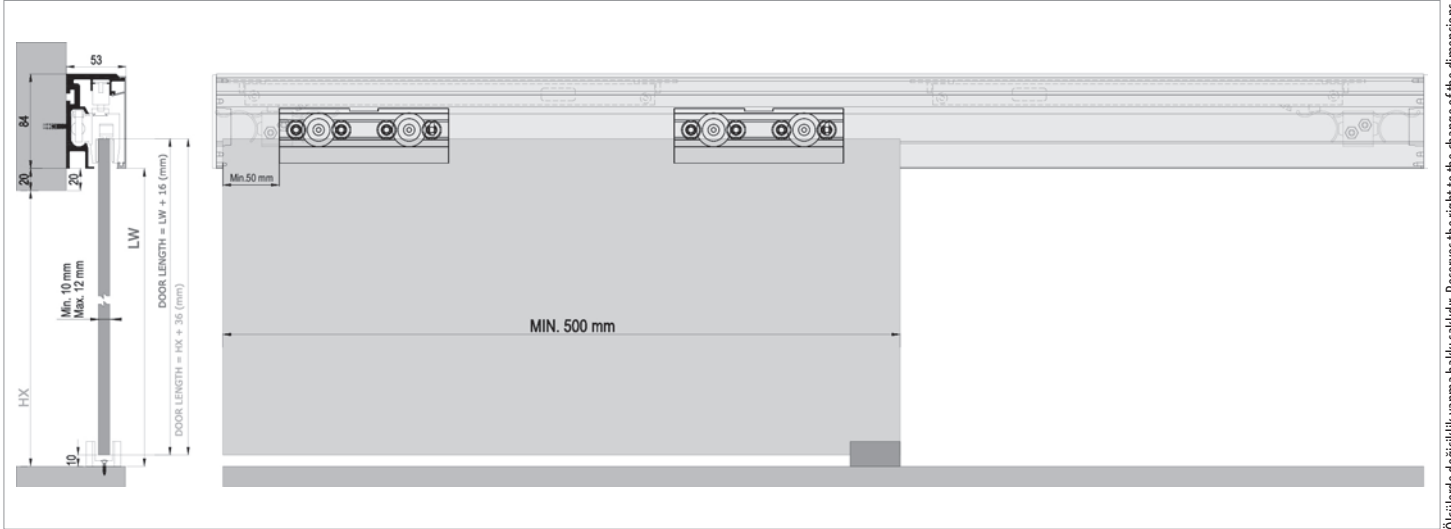

Ölçülerde değişiklik yapma hakkı saklıdır. Reserves the right to the change of the dimensions.

Uygulama / Application



Kod / Code No	Açıklama / Description	Renk / Colour	Birim / Unit			Profil mt. / Profiles mt.			Bağ / Bnd.
123-9912-1410	120 Kg Yavaşlatıcılı Sürme Cam Kapı Sistemi / Sliding Glass Door System	Gri / Grey	1 Kapı / 1 Kit	4	192	-	-	-	-
150-7012-1411	Alüminyum Üst Ray Profili / Aluminium Top Rail Profile	Eloksal / Mat Anodized	mt.	-	-	2,0	3,0	-	6 ad/pcs
150-7013-1411	Alüminyum Alın Kapama Profili / Aluminum Covering Profile	Eloksal / Mat Anodized	mt.	-	-	2,0	3,0	-	6 ad/pcs

GlassDoor 9910

123-9910

80 KG AYARLI SÜRME CAM KAPI SİSTEMİ
80 KG ADJUSTABLE SLIDING GLASS DOOR SYSTEM

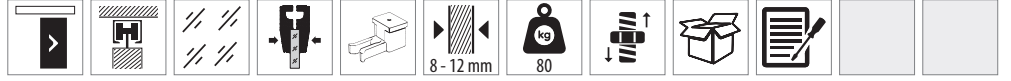

123-9910 1 Takım İçeriği / 1 Kit Includes

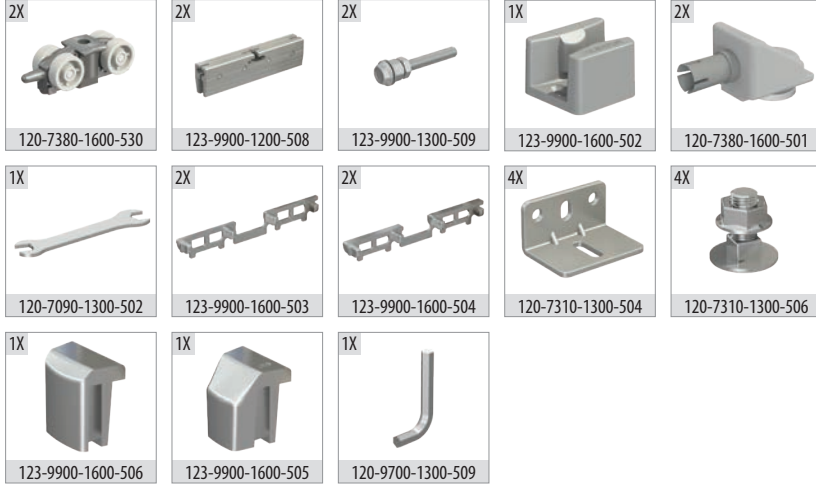

Ray Profilleri / Rail Profiles

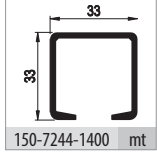

Uygulama / Application



Teknik Detay / Technical Detail

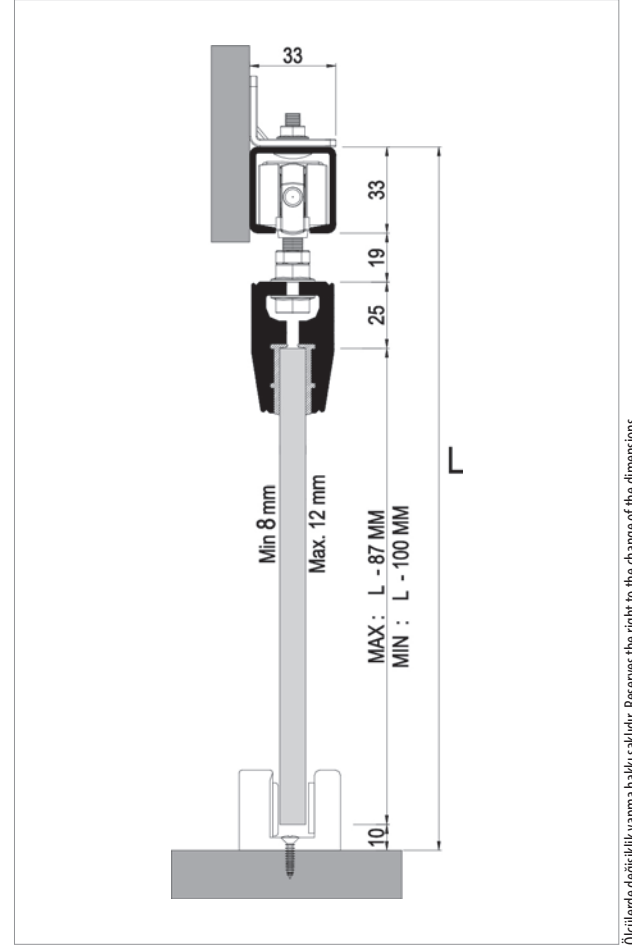

Ölçülerde değişiklik yapma hakkı saklıdır. Reserves the right to the change of the dimensions.

Kod / Code No	Açıklama / Description	Renk / Colour	Birim / Unit			Profil mt. / Profiles mt.	Bağ / Bnd.
123-9910-1200	80 Kg Sürme Cam Kapi Sistemi / Sliding Glass Door System	Gri / Grey	1 Kapi / 1 Kit	12	216	- - -	-
150-7244-1400	Alüminyum Üst Ray Profili / Aluminium Top Rail Profile	Pres / Uncoated	mt	-	-	2,0 - 3,0	6 ad/pcs

GlassDoor 9911

123-9911

80 KG AYARLI SÜRME CAM KAPI SİSTEMİ
80 KG ADJUSTABLE SLIDING GLASS DOOR SYSTEM

Özel Üretim
Special Production

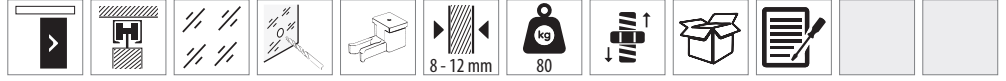

Bilgi / Information

- Bu ürün camda delme işlemi gerektirmektedir.
- This product need drilling on the glass.



123-9911 1 Takım İçeriği / 1 Kit Includes

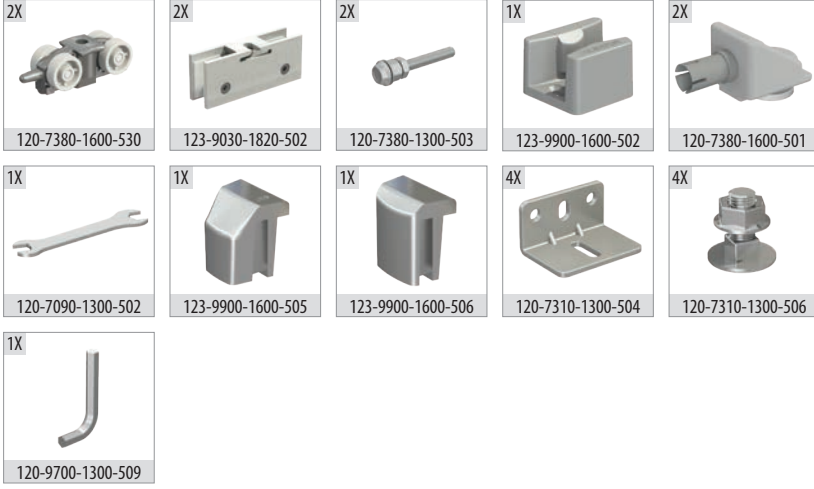

Ray Profilleri / Rail Profiles

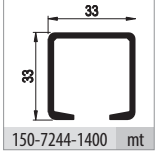

Uygulama / Application



Teknik Detay / Technical Detail

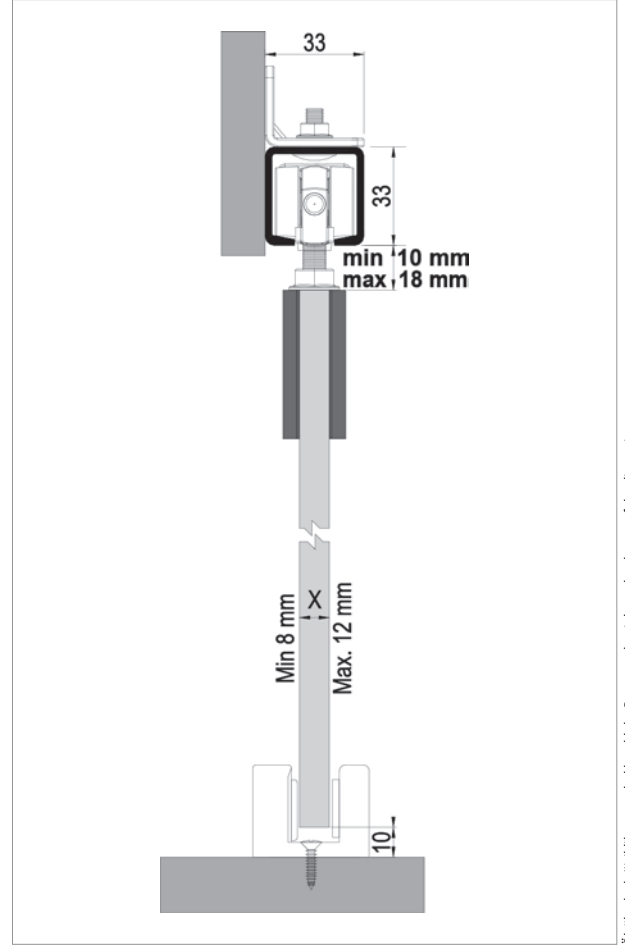

Ölçülerde değişiklik yapma hakkı saklıdır. Reserves the right to the change of the dimensions.

Kod / Code No	Açıklama / Description	Renk / Colour	Birim / Unit			Profil mt. / Profiles mt.	Bağ / Bnd.		
123-9911-1820	80 Kg Sürme Cam Kapi Sistemi / Sliding Glass Door System	Gri / Grey	1 Kapi / 1 Kit	12	216	-	-	-	
150-7244-1400	Alüminyum Üst Ray Profili / Aluminium Top Rail Profile	Pres / Uncoated	mt	-	-	2,0	-	3,0	6 ad/pcs

GlassDoor 9900

123-9900

120 KG AYARLI SÜRME CAM KAPI SİSTEMİ
120 KG ADJUSTABLE SLIDING GLASS DOOR SYSTEM

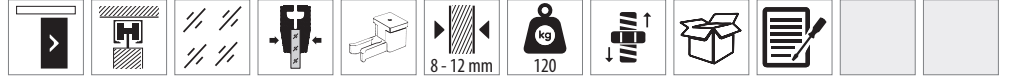

123-9900 1 Takım İçeriği / 1 Kit Includes

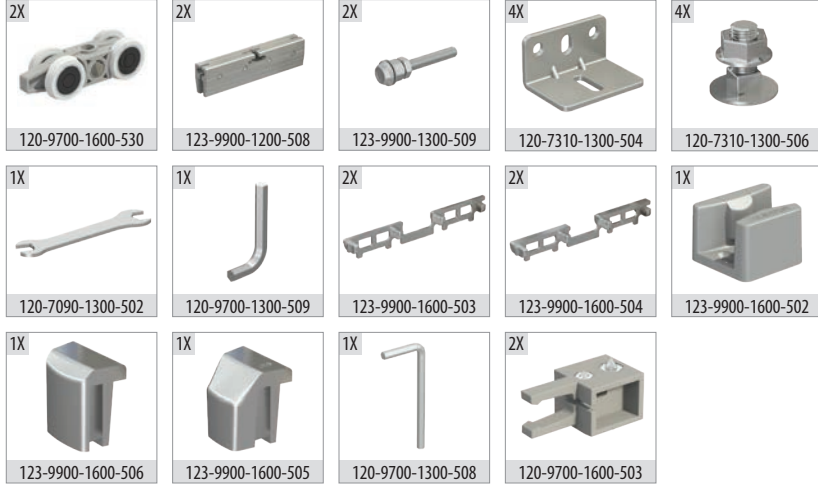

Ray Profilleri / Rail Profiles

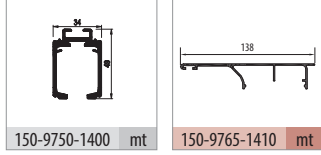

Uygulama / Application



Teknik Detay / Technical Detail

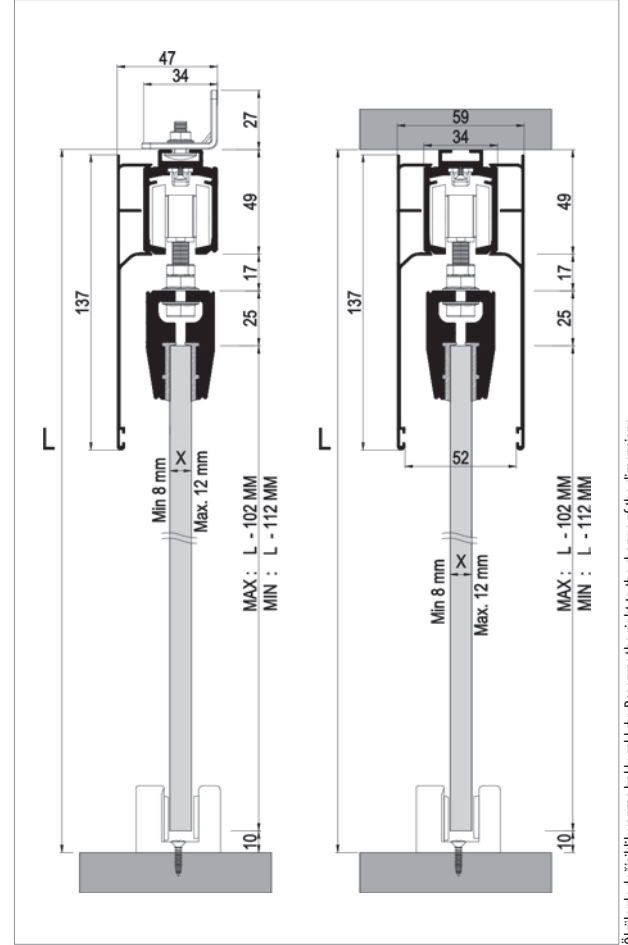

Ölçülerde değişiklik yapma hakkı saklıdır. Reserves the right to the change of the dimensions.

Kod / Code No	Açıklama / Description	Renk / Colour	Birim / Unit			Profil mt. / Profiles mt.	Bağ / Bnd.
123-9900-1200	120 Kg Sürme Cam Kapı Sistemi / Sliding Glass Door System	Gri / Grey	1 Kapı / 1 Kit	12	216	-	-
150-9750-1400	Alüminyum Üst Ray Profili / Aluminium Top Rail Profile	Pres / Uncoated	mt	-	-	2,0	3,0
150-9765-1410	Alüminyum Alın Kapama / Aluminium Cover Front	Eloksal / Mat Anodized	mt	-	-	2,0	3,0

GlassDoor 9030

123-9030

60 KG AYARLI ÇİFT YÖNE YAVAŞLATICILI SÜRME CAM KAPI SİSTEMİ
60 KG ADJUSTABLE SLIDING GLASS DOOR SYSTEM - TWO WAY SOFT CLOSING

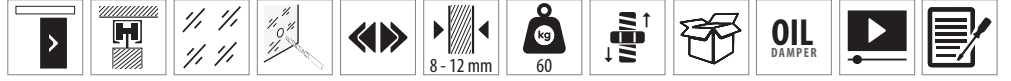

Bilgi / Information

- Minimum kapı genişliği 650 mm olmalıdır.
- Bu ürün camda delme işlemi gerektirmektedir.
- Min. Door width 650 mm
- This product need drilling on the glass.

Yavaşlatıcı Alternatifi / Soft Closer Alternative

- Sistem üzerinde çift yöne yavaşlatıcı mevcuttur.
- The system has two way soft closing.



123-9030 1 Takım İçeriği / 1 Kit Includes

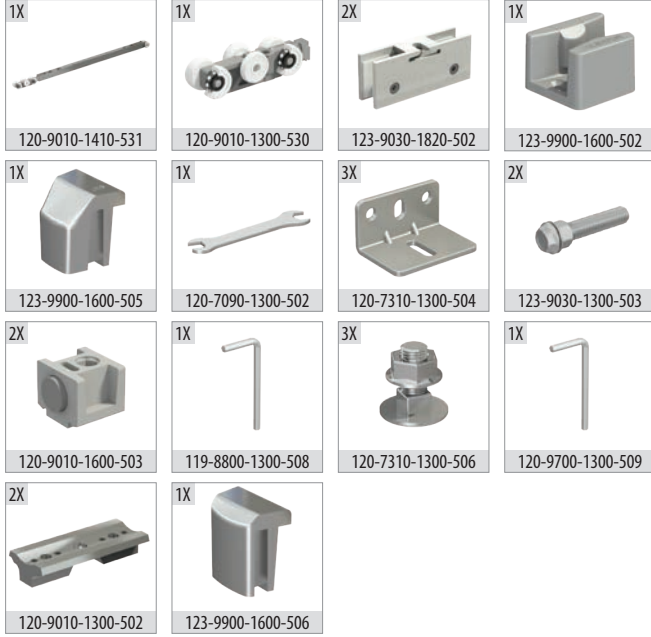

Ray Profilleri / Rail Profiles

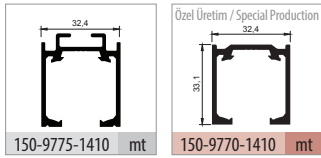

Uygulama / Application



Teknik Detay / Technical Detail

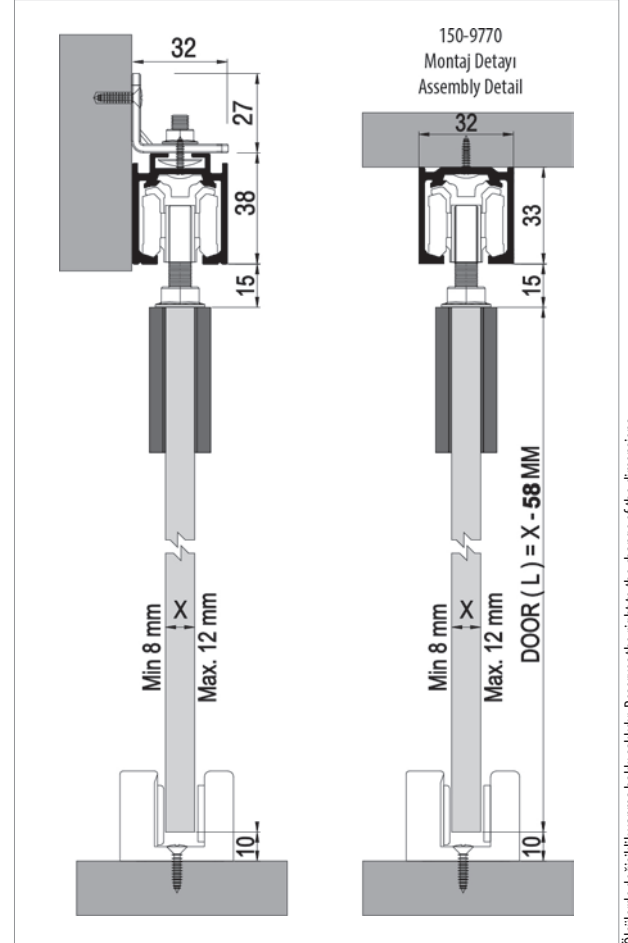

Ölçülerde değişiklik yapma hakkı saklıdır. Reserves the right to the change of the dimensions.

Kod / Code No	Açıklama / Description	Renk / Colour	Birim / Unit			Profil mt. / Profiles mt.	Bağ / Bnd.
123-9030-1820	60 Kg Yavaşlatıcılı Sürme Cam Kapı Sistemi / Sliding Glass Door System	Gri / Grey	1 Kapı / 1 Kit	4	192	-	-
150-9775-1410	Alüminyum Üst Ray Profili / Aluminium Top Rail Profile	Eloksal / Mat Anodized	mt.	-	-	2,0 3,0	6 ad/pcs

GlassDoor 9902

123-9902

120 KG AYARLI TEK YÖNE YAVAŞLATICILI SÜRME CAM KAPI SİSTEMİ
120 KG ADJUSTABLE GLASS SLIDING DOOR SYSTEM ONE WAY SOFT CLOSING

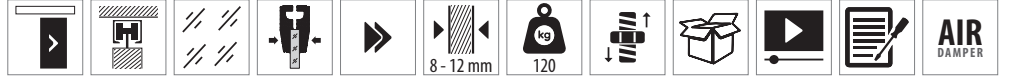

Bilgi / Information

- Minimum kapı genişliği 600 mm olmalıdır.
- Min. Door width 600 mm

Yavaşlatıcı Alternatifi / Soft Closer Alternative

- Sistem üzerinde tek yöne yavaşlatıcı mevcuttur.
- The system has one way soft closing.



123-9902 1 Takım İçeriği / 1 Kit Includes



Ray Profilleri / Rail Profiles

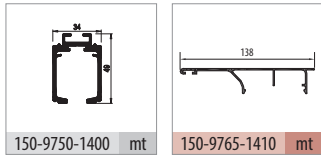

Uygulama / Application



Teknik Detay / Technical Detail

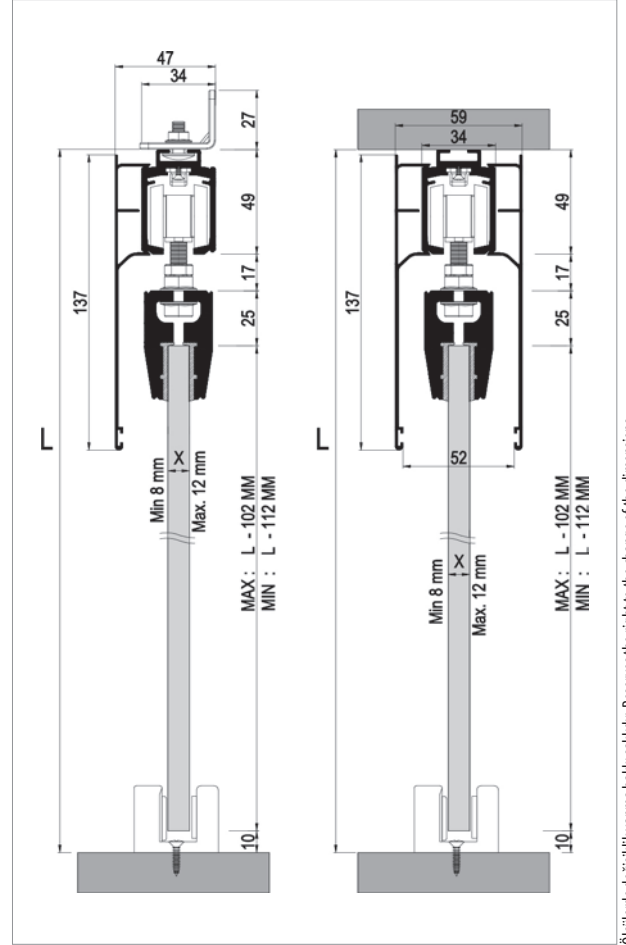

Kod / Code No	Açıklama / Description	Renk / Colour	Birim / Unit			Profil mt. / Profiles mt.	Bağ / Bnd.
123-9902-1200	120 Kg Yavaşlatıcılı Sürme Cam Kapı Sistemi / Sliding Glass Door System Has Soft Closing	Gri / Grey	1 Kapı / 1 Kit	12	216	-	-
150-9750-1400	Alüminyum Üst Ray Profili / Aluminium Top Rail Profile	Pres / Uncoated	mt	-	-	2,0	3,0
150-9765-1410	Alüminyum Alın Kapama / Aluminium Cover Front	Eloksal / Mat Anodized	mt	-	-	2,0	3,0

GlassDoor 9921

123-9921

120 KG AYARLI ÇİFT YÖNE YAVAŞLATICILI SÜRME CAM KAPI SİSTEMİ
120 KG ADJUSTABLE GLASS SLIDING DOOR SYSTEM TWO WAY SOFT CLOSING

Özel Üretim
Special Production

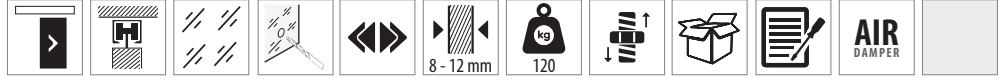

Bilgi / Information

- Minimum kapı genişliği 870 mm olmalıdır.
- Bu ürün camda delme işlemi gerektirmektedir.
- Min. Door width 870 mm
- This product need drilling on the glass.

Yavaşlatıcı Alternatifi / Soft Closer Alternative

- Sistem üzerinde çift yöne yavaşlatıcı mevcuttur.
- The system has two way soft closing.



123-9921 1 Takım İçeriği / 1 Kit Includes

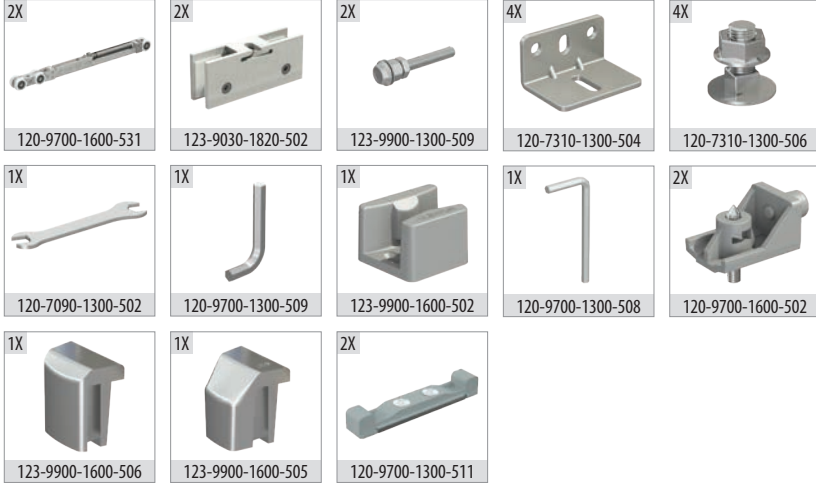

Ray Profilleri / Rail Profiles

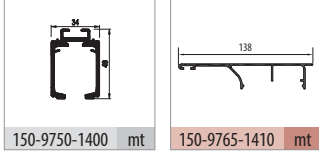

Uygulama / Application



Teknik Detay / Technical Detail

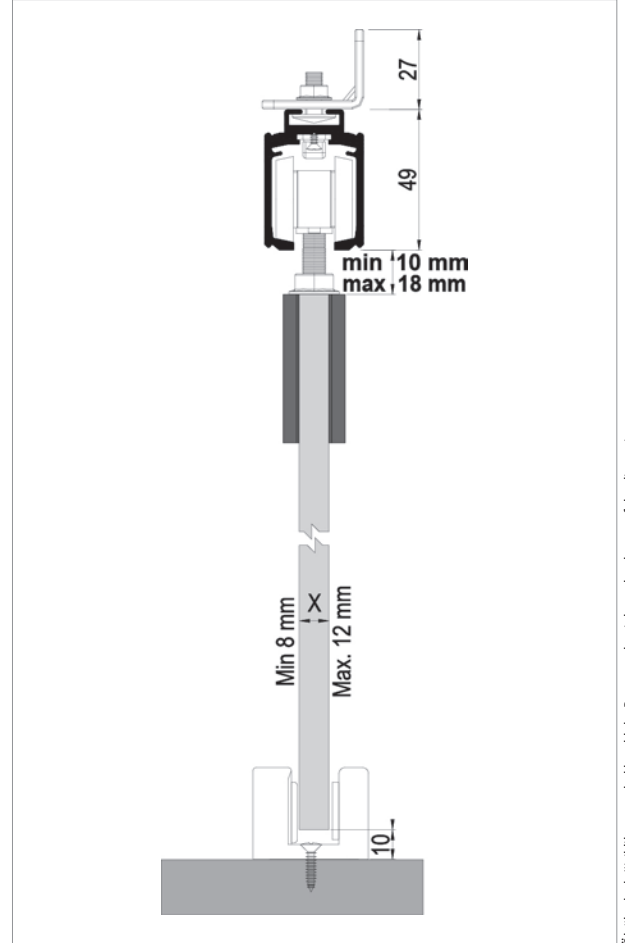

Ölçülerde değişiklik yapma hakkı saklıdır. Reserves the right to the change of the dimensions.

Kod / Code No	Açıklama / Description	Renk / Colour	Birim / Unit			Profil mt. / Profiles mt.			Bağ / Bnd.
123-9921-1820	120 Kg Yavaşlatıcılı Sürme Cam Kapı Sistemi / Sliding Glass Door System Has Soft Closing	Gri / Grey	1 Kapı / 1 Kit	12	216	-	-	-	-
150-9750-1400	Alüminyum Üst Ray Profili / Aluminium Top Rail Profile	Pres / Uncoated	mt	-	-	2,0	-	3,0	2 ad/pcs
150-9765-1410	Alüminyum Alın Kapama / Aluminium Cover Front	Eloksal / Mat Anodized	mt	-	-	2,0	-	3,0	2 ad/pcs

GlassDoor 9980

123-9980

120 KG AYARLI ÇİFT YÖNE YAVAŞLATICILI SÜRME CAM KAPI SİSTEMİ
120 KG ADJUSTABLE GLASS SLIDING DOOR SYSTEM TWO WAY SOFT CLOSING

Yeni Ürün
New Product

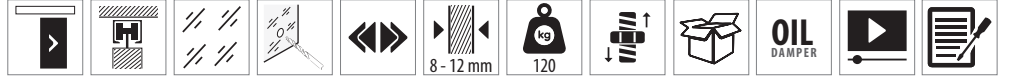

Bilgi / Information

- Minimum kapı genişliği 658 mm olmalıdır.
- Bu ürün camda delme işlemi gerektirmektedir.
- Min. Door width 658 mm
- This product need drilling on the glass.

Yavaşlatıcı Alternatifi / Soft Closer Alternative

- Sistem üzerinde çift yöne yavaşlatıcı mevcuttur.
- The system has two way soft closing.



123-9980 1 Takım İçeriği / 1 Kit Includes

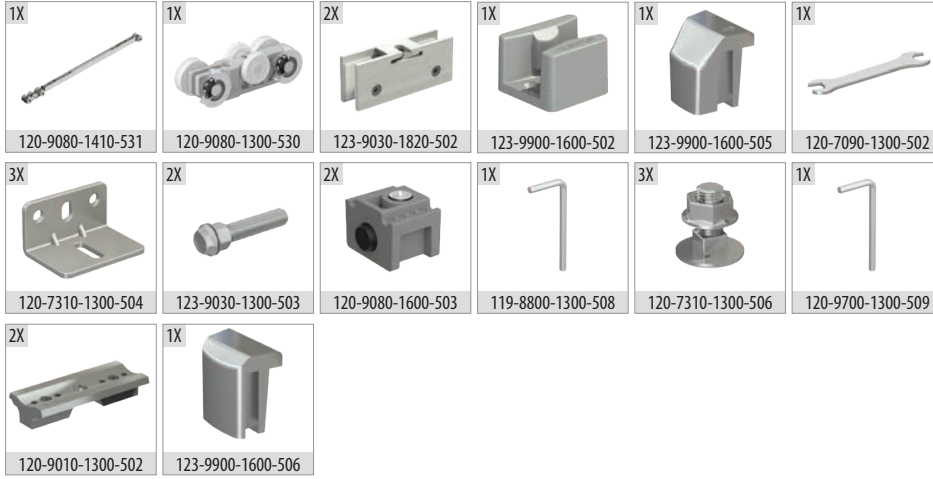

Ray Profilleri / Rail Profiles

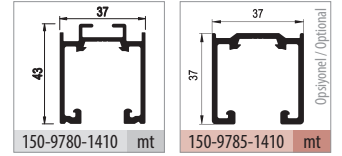

Teknik Detay / Technical Detail

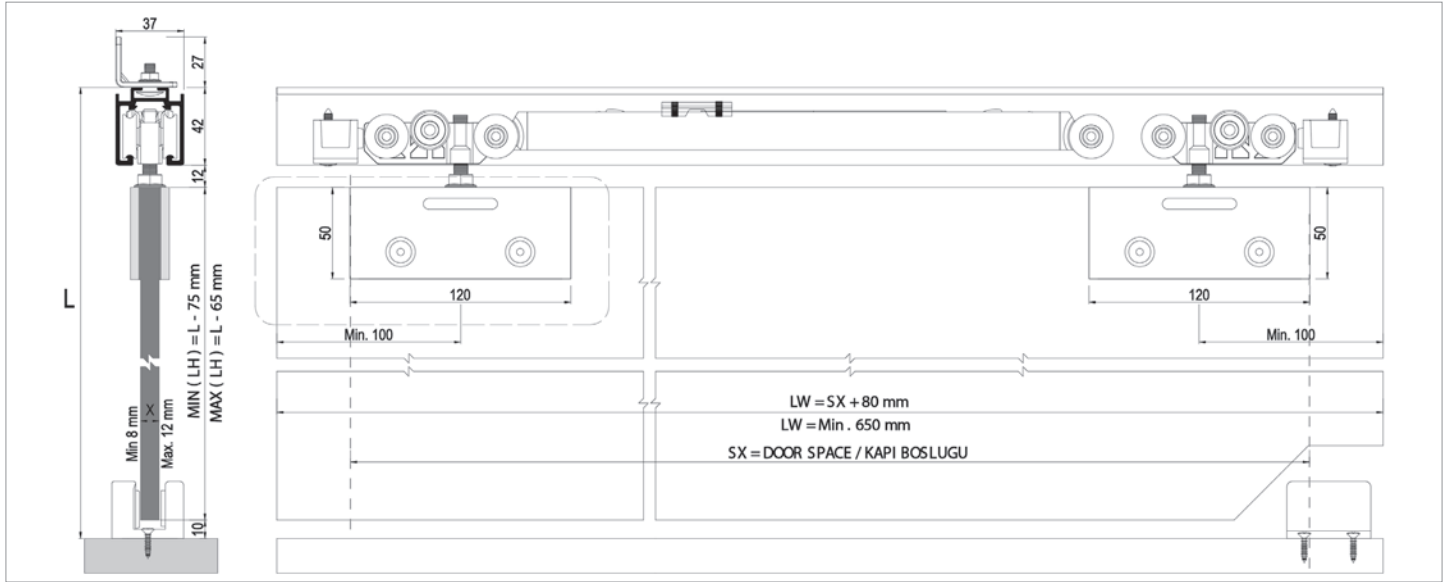

* Duvar içi uygulamalarda, mekanizmanın hareketli teker bloğu sayesinde ray içi montajını kolaylaştırmaktadır.

* In wall-mounted applications, the mechanism's movable wheel block facilitates installation within the rail.

Ölçülerde değişiklik yapma hakkı saklıdır. Reserves the right to the change of the dimensions.

Kod / Code No	Açıklama / Description	Renk / Colour	Birim / Unit			Profil mt. / Profiles mt.			Bağ / Bnd.
123-9980-1820	120 Kg Yav. Sürme Cam Kapı Sistemi / Sliding Glass Door System Has Soft Closing	Gri / Grey	1 Kapı / 1 Kit	4	192	-	-	-	-
150-9780-1410	Alüminyum Üst Ray Profili / Aluminium Top Rail Profile	Eloksal / Mat Anodized	mt.	-	-	2,0	3,0	-	6 ad/pcs
150-9785-1410	Alüminyum Üst Ray Profili / Aluminium Top Rail Profile	Eloksal / Mat Anodized	mt.	-	-	2,0	3,0	-	6 ad/pcs

GlassDoor 9985

123-9985

120 KG AYARLI ÇİFT YÖNE YAVAŞLATICILI SÜRME CAM KAPI SİSTEMİ
120 KG ADJUSTABLE GLASS SLIDING DOOR SYSTEM TWO WAY SOFT CLOSING

Yeni Ürün
New Product



Bilgi / Information

















- Minimum kapı genişliği 735 mm olmalıdır.
- Min. Door width 735 mm

Yavaşlatıcı Alternatifi / Soft Closer Alternative

- Sistem üzerinde çift yöne yavaşlatıcı mevcuttur.
- The system has two way soft closing.



123-9985 1 Takım İçeriği / 1 Kit Includes

1X  120-9080-1410-531	1X  120-9080-1300-530	2X  120-9010-1300-502	2X  123-9900-1200-508	2X  120-7090-1300-504	1X  123-9900-1600-502
3X  120-7310-1300-504	1X  120-7090-1300-502	2X  120-9080-1600-503	1X  119-8800-1300-508	3X  120-7310-1300-506	1X  120-9700-1300-509
2X  123-9900-1600-503	2X  123-9900-1600-504	1X  123-9900-1600-506	1X  123-9900-1600-505		

Ray Profilleri / Rail Profiles

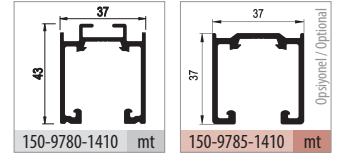

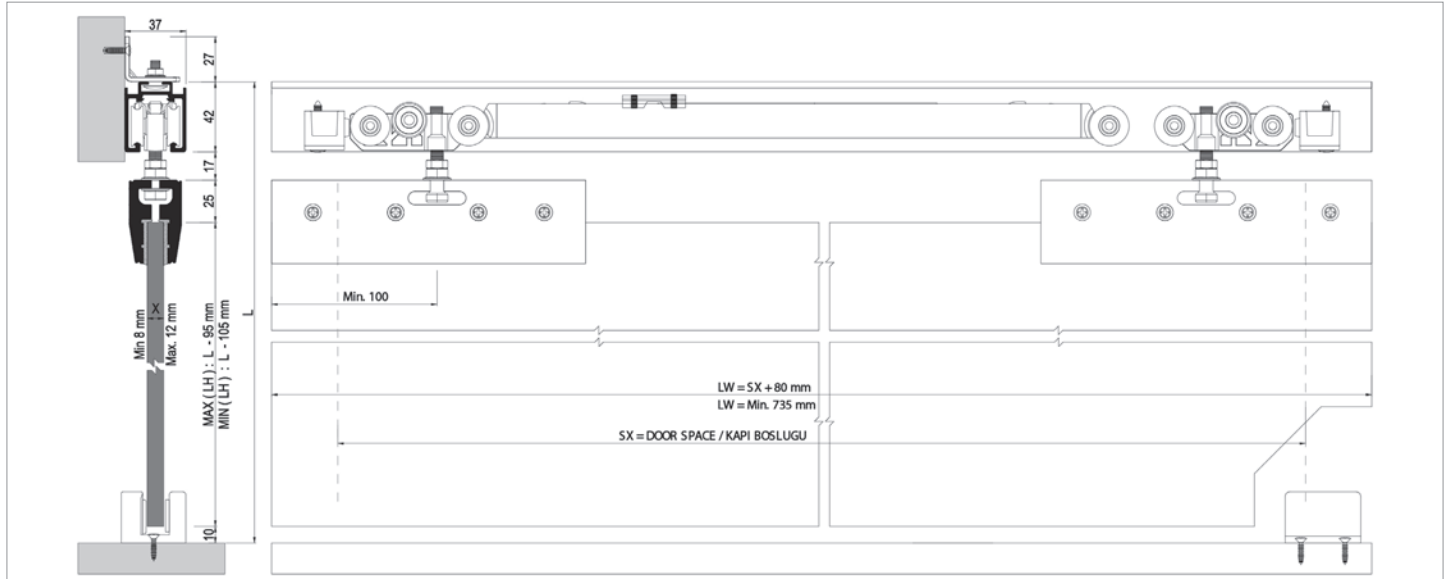

Teknik Detay / Technical Detail



* Duvar içi uygulamalarda, mekanizmanın hareketli teker bloğu sayesinde ray içi montajını kolaylaştırmaktadır.

* In wall-mounted applications, the mechanism's movable wheel block facilitates installation within the rail.

Kod / Code No	Açıklama / Description	Renk / Colour	Birim / Unit			Profil mt. / Profiles mt.			Bağ / Bnd.
123-9985-1820	120 Kg Yav. Sürme Cam Kapı Sistemi / Sliding Glass Door System Has Soft Closing	Gri / Grey	1 Kapı / 1 Kit	4	192	-	-	-	-
150-9780-1410	Alüminyum Üst Ray Profili / Aluminium Top Rail Profile	Eloksal / Mat Anodized	mt.	-	-	2,0	3,0	-	6 ad/pcs
150-9785-1410	Alüminyum Üst Ray Profili / Aluminium Top Rail Profile	Eloksal / Mat Anodized	mt.	-	-	2,0	3,0	-	6 ad/pcs

Group 124

DoorSync[®] Glass

Cam Senkronize Sürme Kapı Serisi

Funicular Glass Door Series

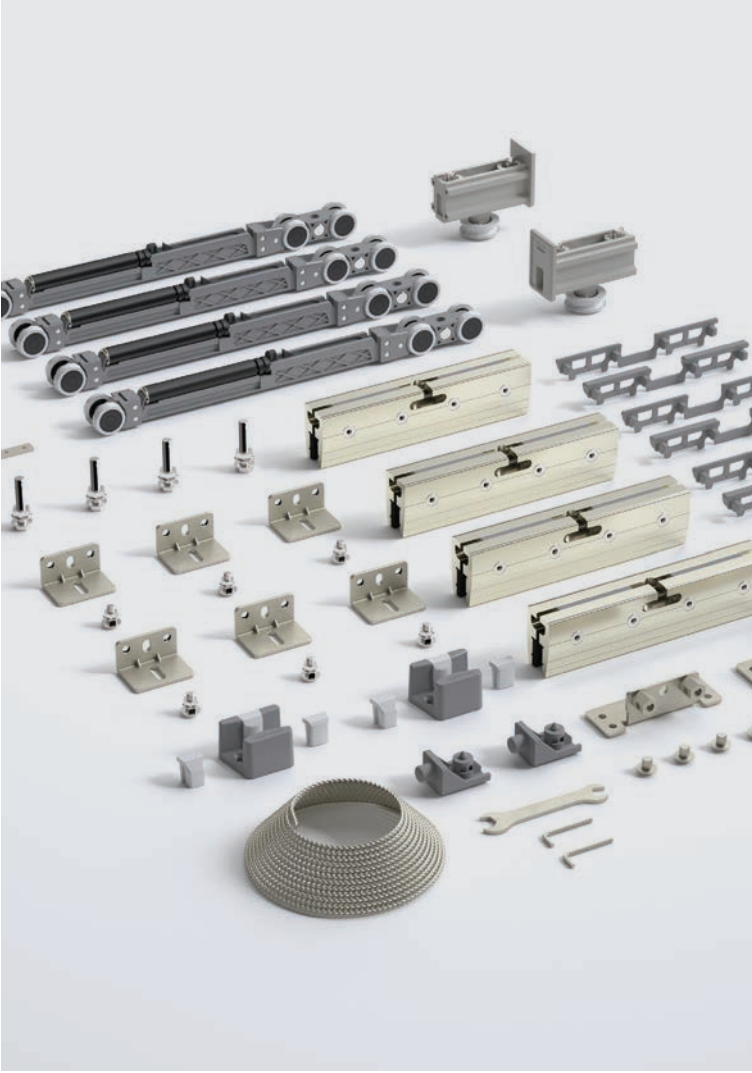

Bu serideki tüm ürünleri incelemek için
QR kodu okutabilirsiniz.

















You can analyze the QR code to see all the
products in these series.



Door Sync 9960

<p>SINCE 1976</p>	 <p>Bearing Systems</p>	<p>EN 1527 100.000 CYCLES TEST</p> 	<p>R The Sliding System</p>
-----------------------	---	--	--



	OEM Kod OEM Code	Ürün Kodu Product Code	Sistem Tipi System Type	Panel Tipi Panel Type	Fren Yönü Brake Direc.	Panel mm	Taşıma Kg Capacity Kg	Video	Üst Ray Upper Rail	Alt Ray Lower Rail	Kapak Adeti Number of Doors	Yavaşlatıcı Dahil Soft Closer Including	Min. Kapı Genişlik mm Min. Door Width mm
1	124-9935	DoorSync 9935				8 - 12	40	✓	150-9775	-	2	✓	550
2	124-9940	DoorSync 9940				8 - 12	80		150-7244	-	2		-
3	124-9950	DoorSync 9950				8 - 12	120		150-9750	-	2		400
4	124-9951	DoorSync 9951				8 - 12	120	✓	150-9750	-	2	✓	600
5	124-9960	DoorSync 9960				8 - 12	120	✓	150-9750	-	2	✓	900
6	124-9981	DoorSync 9981				8 - 12	120	✓	150-9780	-	2	✓	-

• Verilen ölçüler bağlayıcı değildir. Önerilen kurulum ölçüleridir. Albatür ürün özelliklerinde haber vermeden değişiklik yapabilir.

• The given dimension are not binding. These are recommended asamble dimensions. Albatür can make alteration to product specification without notice.

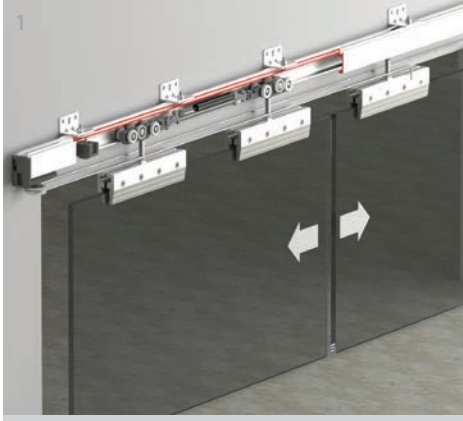

124-9935

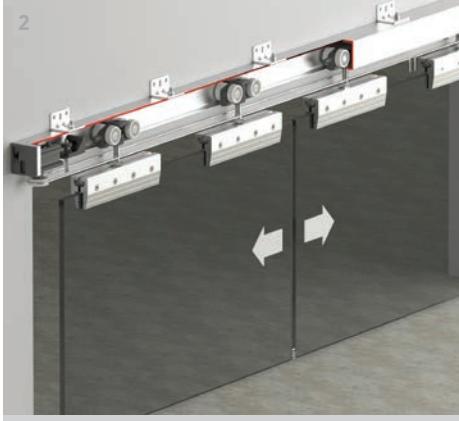

124-9940

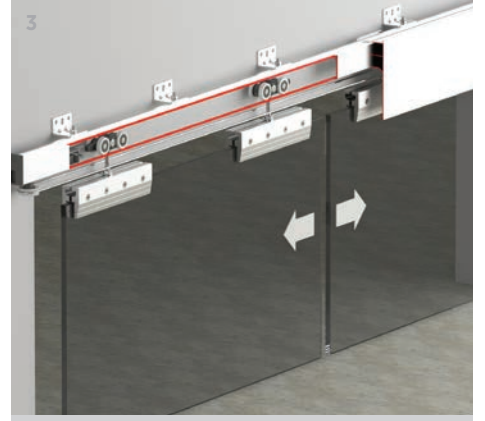

124-9950

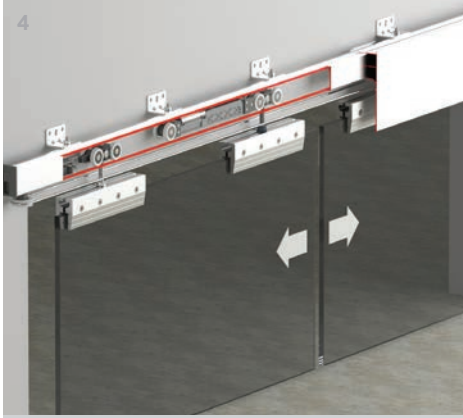

124-9951

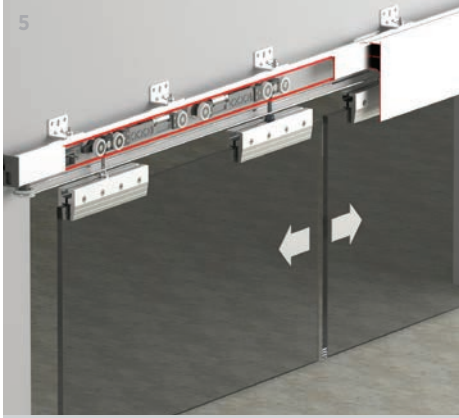

124-9960

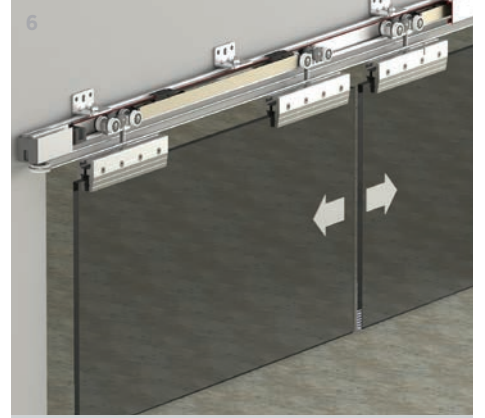

124-9981

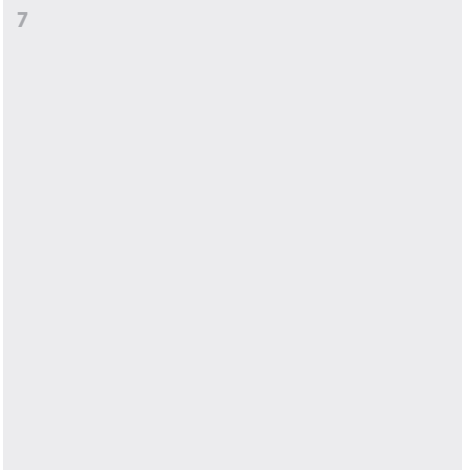

7

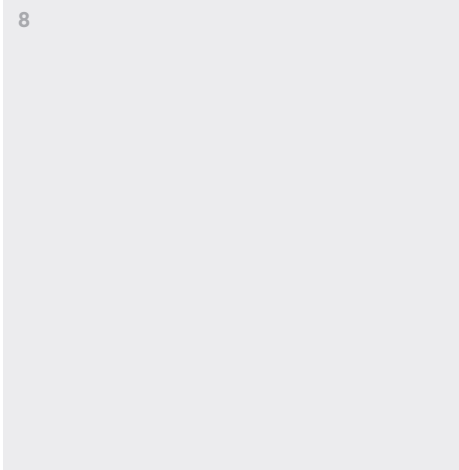

8

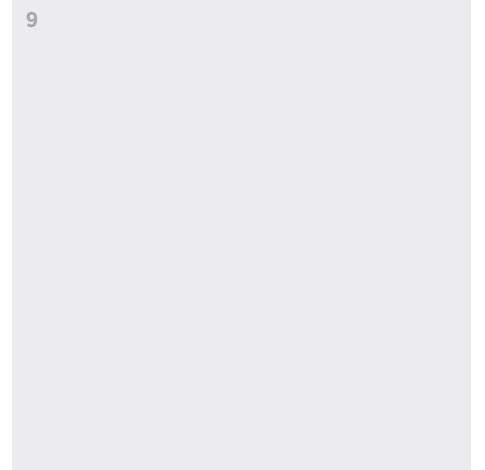

9

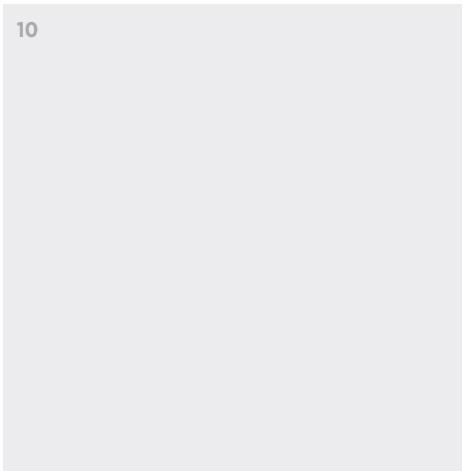

10

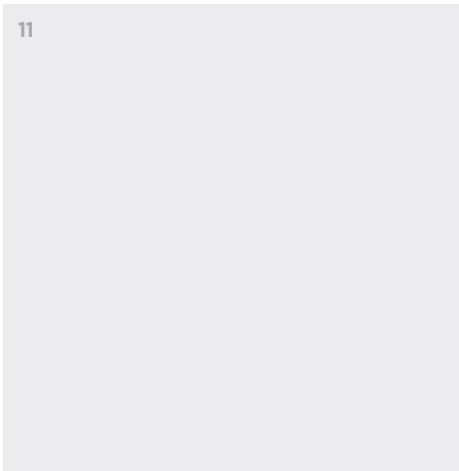

11

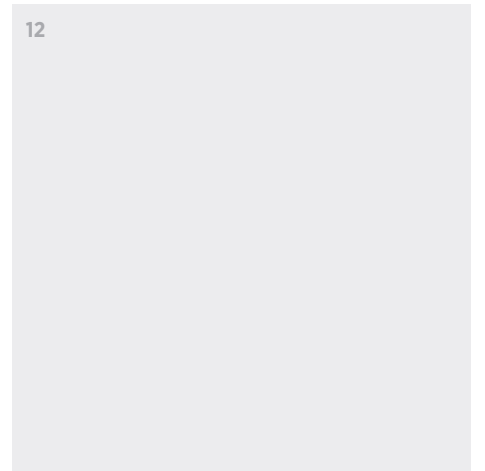

12

DoorSync 9935

124-9935

40 KG AYARLI ÇİFT YÖNE YAVAŞLATICILI HALATLI SÜRME CAM KAPI SİSTEMİ
40 KG ADJUSTABLE FUNICULAR SLIDING GLASS DOOR SYSTEM

Özel Üretim
Special Production

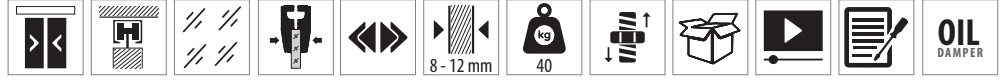

Bilgi / Information

- Minimum kapı genişliği 550 mm olmalıdır.
- Min. Door width 550 mm

Yavaşlatıcı Alternatifi / Soft Closer Alternative

- Sistem üzerinde çift yöne yavaşlatıcı mevcuttur.
- The system has two way soft closing.



124-9935 1 Takım İçeriği / 1 Kit Includes

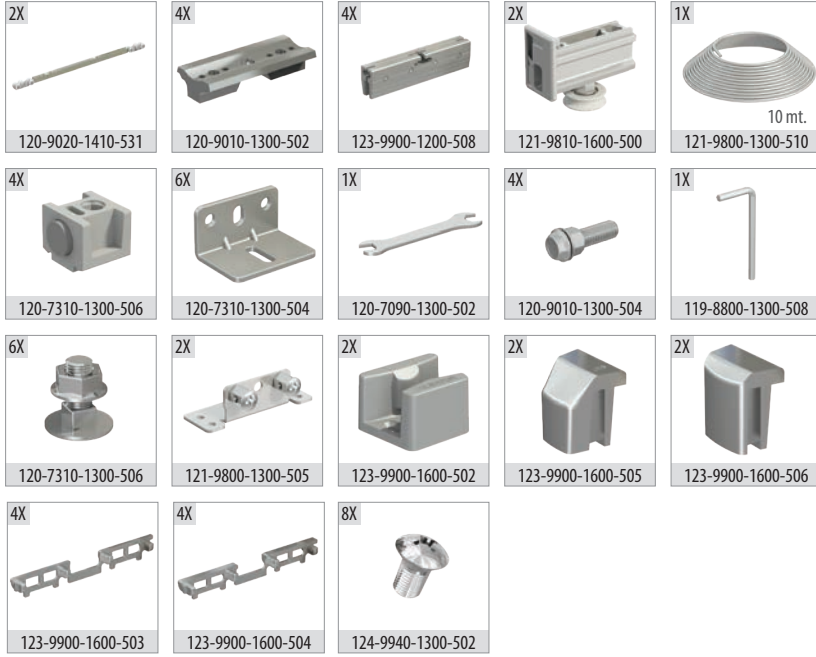

Ray Profilleri / Rail Profiles

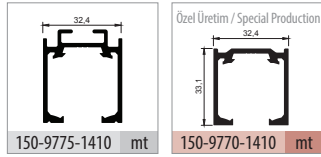

Uygulama / Application



Teknik Detay / Technical Detail

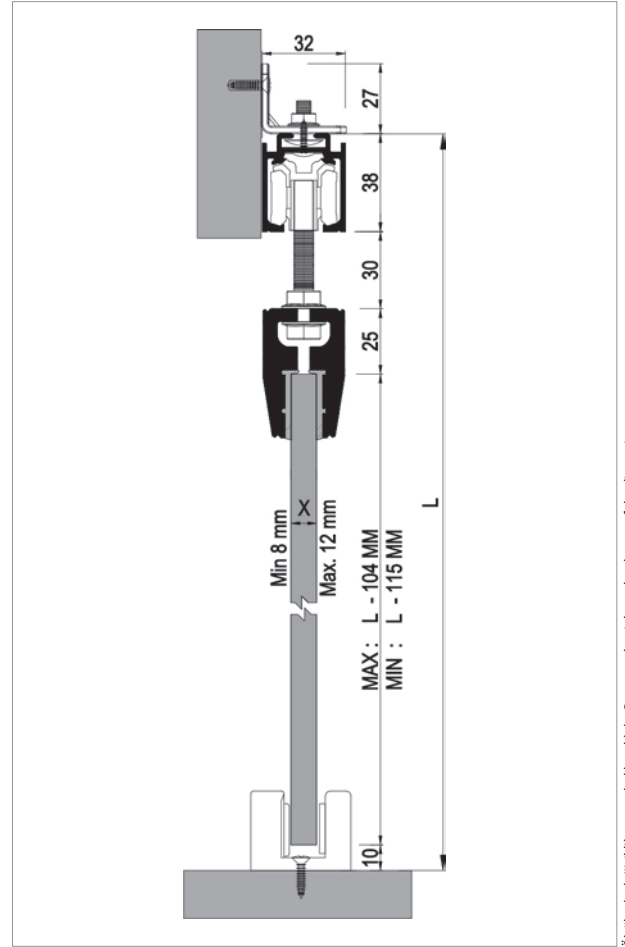

Ölçülerde değişiklik yapma hakkı saklıdır. Reserves the right to the change of the dimensions.

Kod / Code No	Açıklama / Description	Renk / Colour	Birim / Unit			Profil mt. / Profiles mt.	Bağ / Bnd.
124-9935-1200	40 Kg Yavaşlatıcılı Sürme Cam Kapı Sistemi / Sliding Glass Door System	Gri / Grey	2 Kapı / 1 Set	1	100	-	-
150-9775-1410	Alüminyum Üst Ray Profili / Aluminium Top Rail Profile	Eloksal / Mat Anodized	mt.	-	-	-	6,0 6 ad/pcs

DoorSync 9940

124-9940

80 KG AYARLI HALATLI SÜRME CAM KAPI SİSTEMİ
80 KG ADJUSTABLE FUNICULAR SLIDING GLASS DOOR SYSTEM

Özel Üretim
Special Production

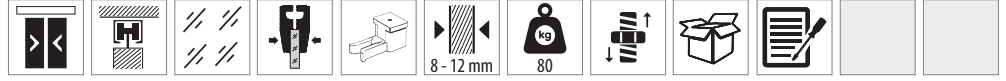
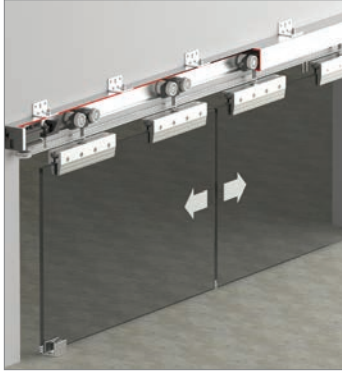

124-9940 1 Set İçeriği / 1 Set Includes

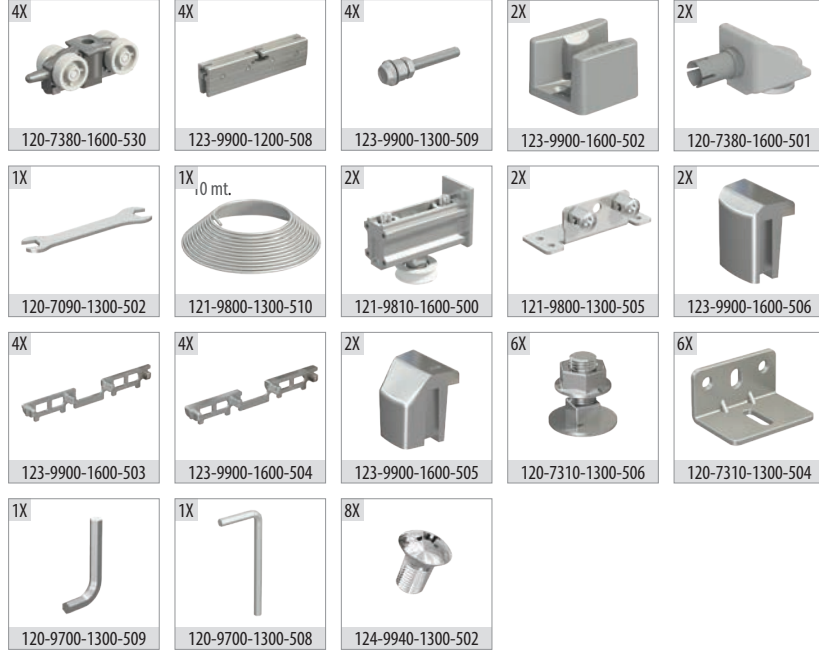

Ray Profilleri / Rail Profiles

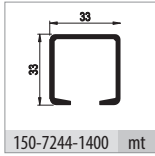

Uygulama / Application



Teknik Detay / Technical Detail

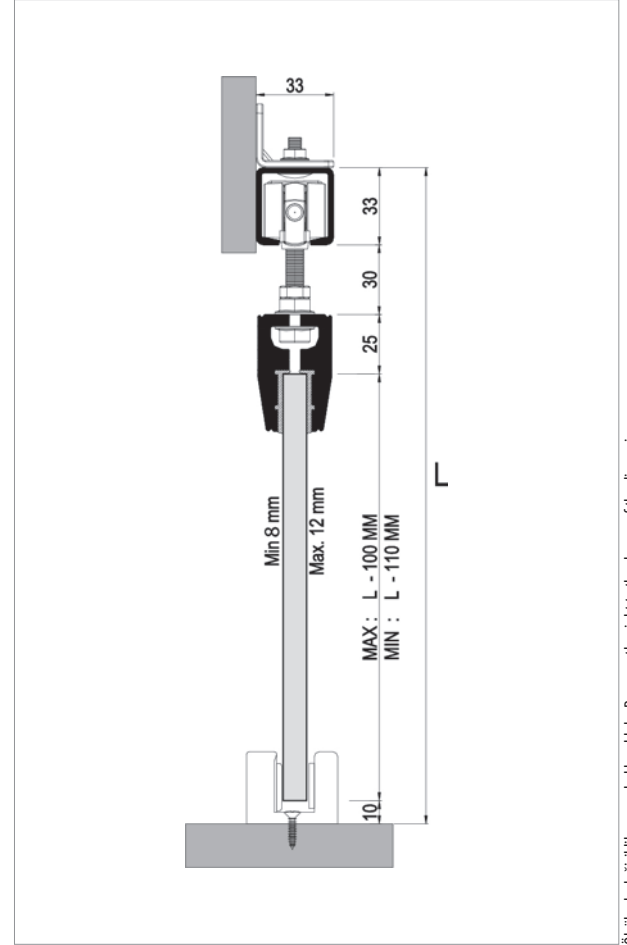

Ölçülerde değişiklik yapma hakkı saklıdır. Reserves the right to the change of the dimensions.

Kod / Code No	Açıklama / Description	Renk / Colour	Birim / Unit			Profil mt. / Profiles mt.			Bağ / Bnd.
124-9940-1200	80 Kg Senkronize Cam Kapı Sistemi / Funicular Glass Door System	Gri / Grey	2 Kapı / 1 Set	1	100	-	-	-	-
150-7244-1400	Alüminyum Üst Ray Profili / Aluminium Top Rail Profile	Pres / Uncoated	mt	-	-	3,0	4,0	6,0	6 ad/pcs

DoorSync 9950

124-9950

120 KG AYARLI HALATLI SÜRME CAM KAPI SİSTEMİ

120 KG ADJUSTABLE FUNICULAR SLIDING GLASS DOOR SYSTEM

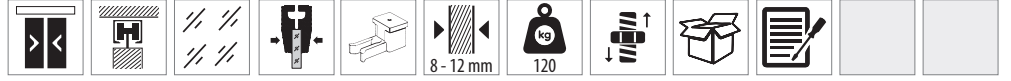
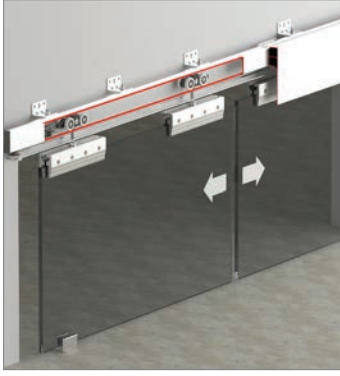

Bilgi / Information

- Minimum kapı genişliği 400 mm olmalıdır.
- Min. Door width 400 mm



124-9950 1 Set İçeriği / 1 Set Includes



Ray Profilleri / Rail Profiles

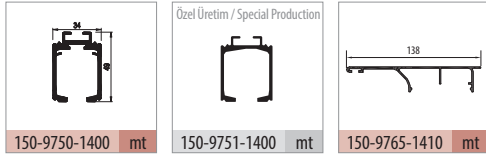

Uygulama / Application



Teknik Detay / Technical Detail

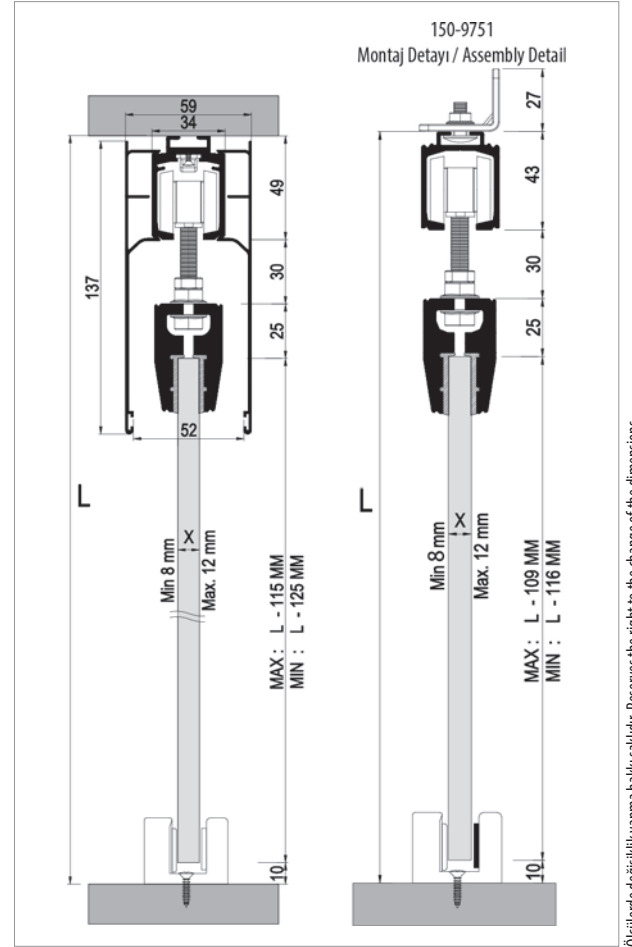

Ölçülerde değişiklik yapma hakkı saklıdır. Reserves the right to the change of the dimensions.

Kod / Code No	Açıklama / Description	Renk / Colour	Birim / Unit			Profil mt. / Profiles mt.	Bağ / Bnd.		
124-9950-1200	120 Kg Senkronize Cam Kapı Sistemi / Funicular Glass Door System	Gri / Grey	2 Kapı / 1 Set	1	100	-	-	-	
150-9750-1400	Alüminyum Üst Ray Profili / Aluminium Top Rail Profile	Pres / Uncoated	mt	-	-	3,0	4,0	6,0	2 ad/pcs
150-9751-1400	Alüminyum Üst Ray Profili / Aluminium Top Rail Profile	Pres / Uncoated	mt	-	-	3,0	4,0	6,0	2 ad/pcs
150-9765-1410	Alüminyum Alın Kapama / Aluminium Cover Front	Eloksal / Mat Anodized	mt	-	-	3,0	4,0	6,0	2 ad/pcs

DoorSync 9951

124-9951

120 KG AYARLI HALATLI TEK YÖNE YAVAŞLATICILI SÜRME CAM KAPI SİSTEMİ
120 KG ADJUSTABLE FUNICULAR SLIDING GLASS DOOR SYSTEM - ONE WAY SOFT CLOSING

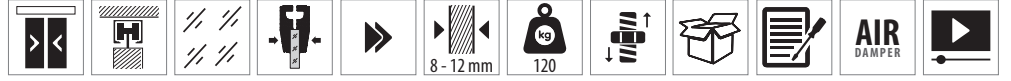
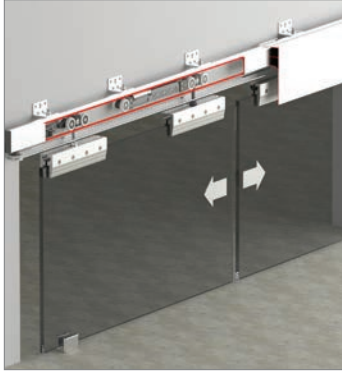

Bilgi / Information

- Minimum kapı genişliği 600 mm olmalıdır.
- Min. Door width 600 mm

Yavaşlatıcı Alternatifi / Soft Closer Alternative

- Sistem üzerinde tek yöne yavaşlatıcı mevcuttur.
- The system has one way soft closing.



124-9951 1 Set İçeriği / 1 Set Includes

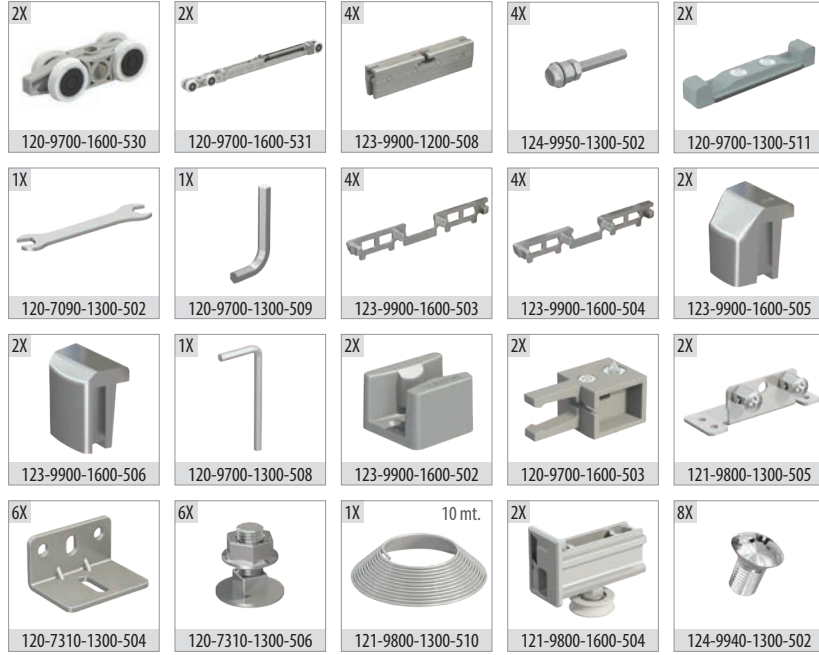

Ray Profilleri / Rail Profiles

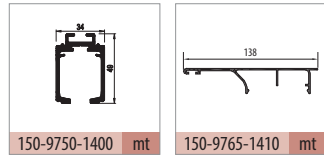

Uygulama / Application



Teknik Detay / Technical Detail

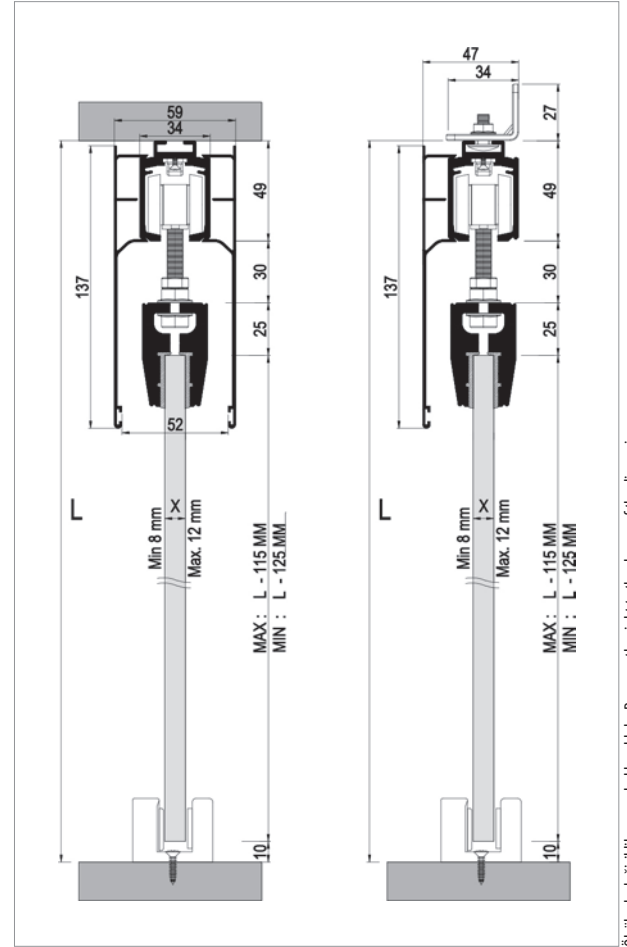

Ölçülerde değişiklik yapma hakkı saklıdır. Reserves the right to the change of the dimensions.

Kod / Code No	Açıklama / Description	Renk / Colour	Birim / Unit			Profil mt. / Profiles mt.			Bağ / Bnd.
124-9951-1200	120 Kg Yavaşlatıcılı Senkronize Cam Kapı Sistemi / Funicular Glass Door System	Gri / Grey	2 Kapı / 1 Set	1	100	-	-	-	-
150-9750-1400	Alüminyum Üst Ray Profili / Aluminium Top Rail Profile	Pres / Uncoated	mt	-	-	3,0	4,0	6,0	2 ad/pcs
150-9765-1410	Alüminyum Alın Kapama / Aluminium Cover Front	Eloksal / Mat Anodized	mt	-	-	3,0	4,0	6,0	2 ad/pcs

DoorSync 9960

124-9960

120 KG AYARLI ÇİFT YÖNE YAVAŞLATICILI HALATLI SÜRME CAM KAPI SİSTEMİ

120 KG ADJUSTABLE FUNICULAR SLIDING GLASS DOOR SYSTEM - TWO WAY SOFT CLOSING

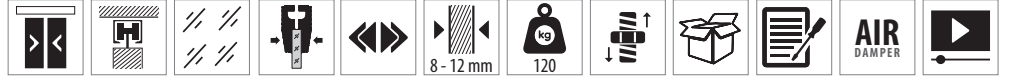
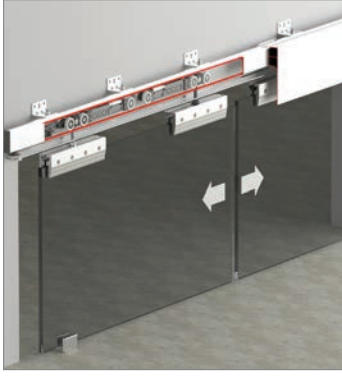

Bilgi / Information

- Minimum kapı genişliği 900 mm olmalıdır.
- Min. Door width 900 mm

Yavaşlatıcı Alternatifi / Soft Closer Alternative

- Sistem üzerinde çift yöne yavaşlatıcı mevcuttur.
- The system has two way soft closing.



124-9960 1 Set İçeriği / 1 Set Includes

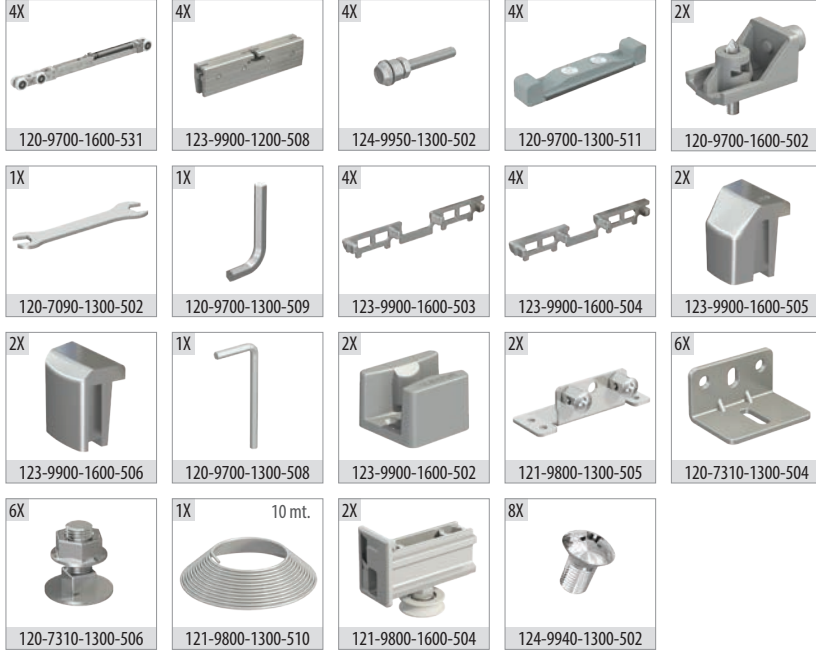

Ray Profilleri / Rail Profiles

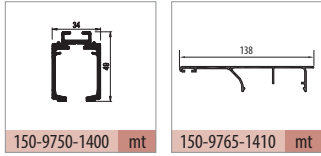

Uygulama / Application



Teknik Detay / Technical Detail

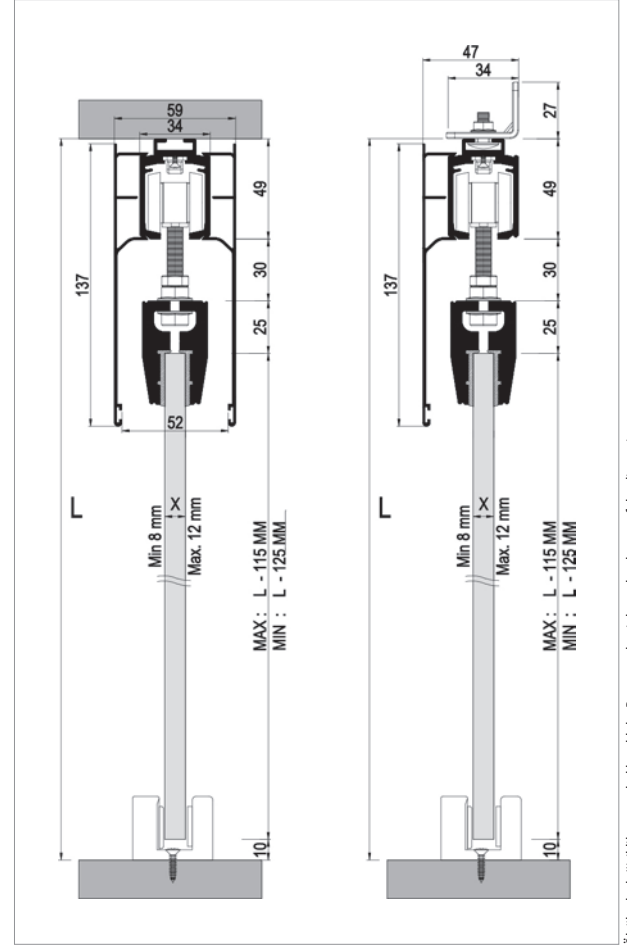

Ölçülerde değişiklik yapma hakkı saklıdır. Reserves the right to the change of the dimensions.

Kod / Code No	Açıklama / Description	Renk / Colour	Birim / Unit			Profil mt. / Profiles mt.			Bağ / Bnd.
124-9960-1200	DoorSync 9960 - 120 Kg Senkronize Cam Kapı Sistemi / Funicular Glass Door System	Gri / Grey	2 Kapı / 1 Set	1	100	-	-	-	-
150-9750-1400	Alüminyum Üst Ray Profili / Aluminium Top Rail Profile	Pres / Uncoated	mt	-	-	3,0	4,0	6,0	2 ad/pcs
150-9765-1410	Alüminyum Alın Kapama / Aluminium Cover Front	Eloksal / Mat Anodized	mt	-	-	3,0	4,0	6,0	2 ad/pcs

DoorSync 9981

124-9981

120 KG AYARLI ÇİFT YÖNE YAVAŞLATICILI HALATLI SÜRME CAM KAPI SİSTEMİ
120 KG ADJUSTABLE FUNICULAR SLIDING GLASS DOOR SYSTEM - TWO WAY SOFT CLOSING

Yeni Ürün
New Product

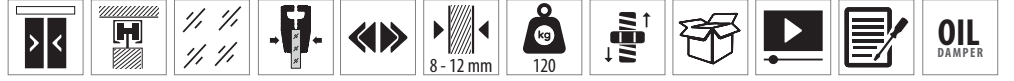

Bilgi / Information

- Minimum kapı genişliği 740 mm olmalıdır.
- Min. Door width 740 mm

Yavaşlatıcı Alternatifi / Soft Closer Alternative

- Sistem üzerinde çift yöne yavaşlatıcı mevcuttur.
- The system has two way soft closing.



124-9981 1 Takım İçeriği / 1 Kit Includes

2X 120-9090-1410-531	4X 120-9010-1300-502	4X 123-9900-1200-508	2X 121-9810-1600-500	1X 121-9800-1300-510 10 mt.	6X 120-7310-1300-504	1X 120-7090-1300-502	4X 120-9010-1300-504	1X 119-8800-1300-508
6X 120-7310-1300-506	2X 121-9800-1300-505	2X 123-9900-1600-502	2X 123-9900-1600-505	4X 120-7310-1300-506	2X 123-9900-1600-506	4X 123-9900-1600-503	4X 123-9900-1600-504	8X 124-9940-1300-502

Ray Profilleri / Rail Profiles

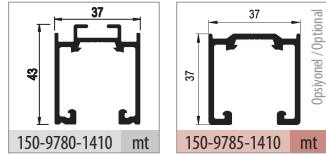

Teknik Detay / Technical Detail

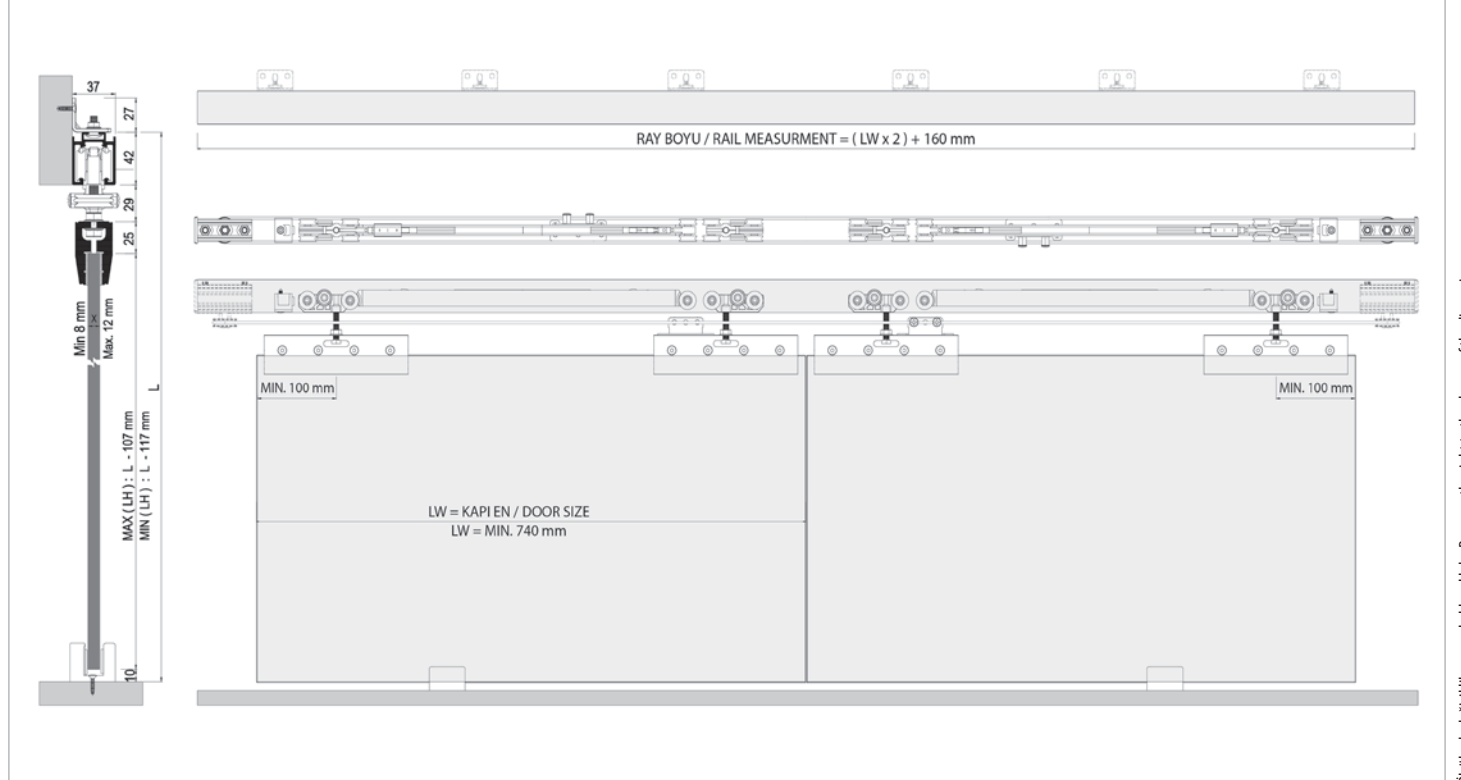

Kod / Code No	Açıklama / Description	Renk / Colour	Birim / Unit			Profil mt. / Profiles mt.	Bağ / Bnd.	
124-9981-1200	DoorSync9981 - 120 KgSürme Kapı Sistemi / Sliding Door System - Soft Closing	Gri / Grey	2 Kapı / 1 Set	4	160	-	-	-
150-9780-1410	Alüminyum Üst Ray Profili / Aluminium Top Rail Profile	Eloksal / Mat Anodized	mt.	-	-	2,0	3,0	6 ad/pcs
150-9785-1410	Alüminyum Üst Ray Profili / Aluminium Top Rail Profile	Eloksal / Mat Anodized	mt.	-	-	2,0	3,0	6 ad/pcs

Group 127

MultiDoor[®]

Teleskopik Ahşap Sürme Kapı Serisi

Telescopic Wooden Sliding Door Series





Bu serideki tüm ürünleri incelemek için QR kodu okutabilirsiniz.









You can analyze the QR code to see all the products in these series.



MultiDoor 450

<p>SINCE 1976</p>	 <p>Bearing Systems</p>	<p>EN 1527 100.000 CYCLES TEST</p> 	<p>R</p> <p>The Sliding System</p>
-----------------------	--	--	---



	OEM Kod OEM Code	Ürün Kodu Product Code	Sistem Tipi System Type	Panel Tipi Panel Type	Fren Yönü Brake Direc.	Panel mm	Taşıma Kg Capacity Kg	Video	Üst Ray Upper Rail	Alt Ray Lower Rail	Yavaşlatıcı Dahil Soft Closer Including	Min. Kapı Genişlik mm Min. Door Width mm
1	127-0100	MultiDoor 100				30 - 50	80	✓	150-9750	150-9162		400
2	127-0150	MultiDoor 150				30 - 50	80	✓	150-9750	150-9162		450
3	127-0200	MultiDoor 200			▶	30 - 50	80	✓	150-9750	150-9162	✓	620
4	127-0250	MultiDoor 250			▶	30 - 50	80	✓	150-9750	150-9162	✓	670
5	127-0260	MultiDoor 260			◀▶	30 - 50	80	✓	150-9750	150-9162	✓	976
6	127-0400	MultiDoor 400			◀▶	30 - 50	60	✓	150-9775	150-9162	✓	770
7	127-0450	MultiDoor 450			◀▶	30 - 50	60	✓	150-9775	150-9162	✓	810
8	127-0500	MultiDoor 500			◀▶	30 - 50	120	✓	150-9780	150-9162	✓	765
9	127-0550	MultiDoor 550			◀▶	30 - 50	120	✓	150-9780	150-9162	✓	790

- Verilen ölçüler bağlayıcı değildir. Önerilen kurulum ölçüleridir. Albatür ürün özelliklerinde haber vermeden değişiklik yapabilir.
- The given dimension are not binding. These are recommended assemble dimensions. Albatür can make alteration to product specification without notice.

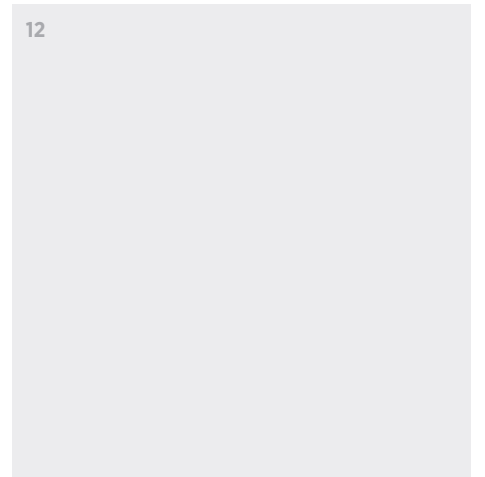
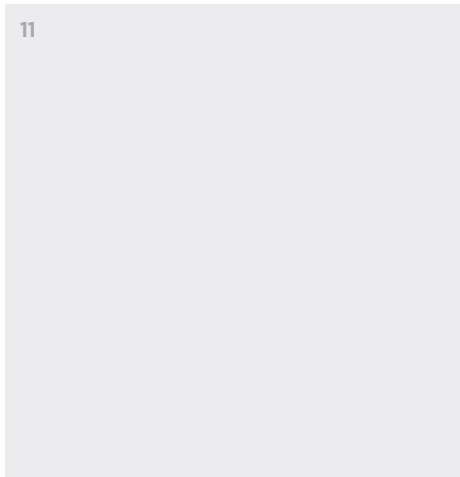
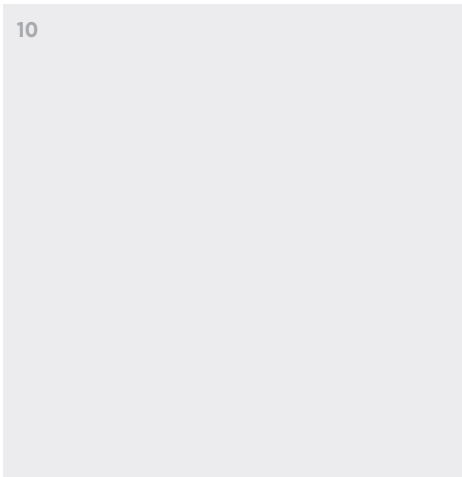
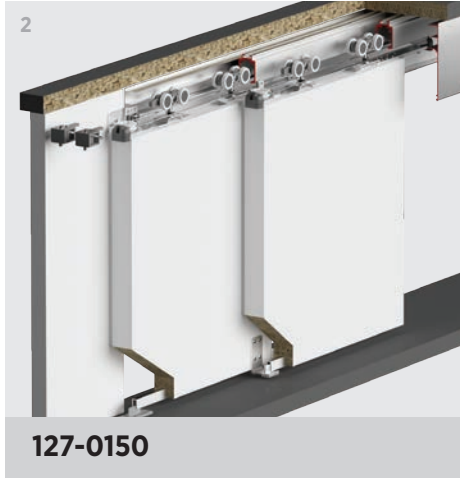
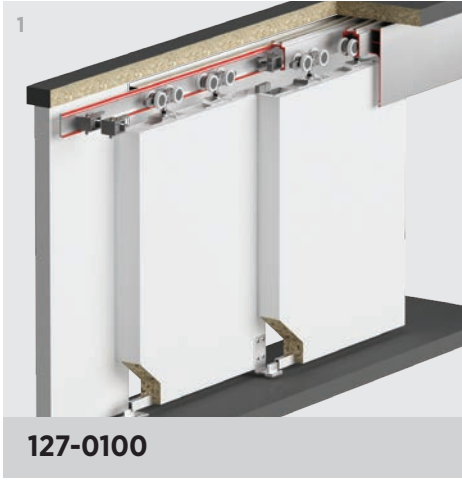

MultiDoor 0100

127-0100

80 KG AYARLI TELESKOPİK SÜRME KAPI SİSTEMİ
80 KG ADJUSTABLE TELESCOPIC SLIDING DOOR SYSTEMS



Bilgi / Information

- Minimum kapı genişliği 400 mm olmalıdır.
- Min. Door width 400 mm

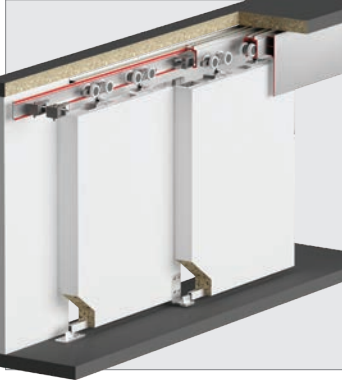

127-0102 1 Set İçeriği / 1 Set Includes

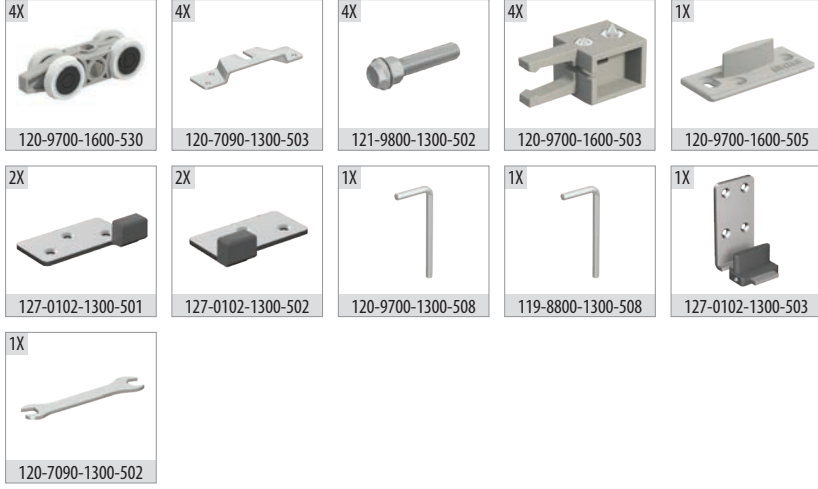

127-0101 1 Takım İçeriği (Opsiyonel Ek Kapı) / 1 Kit Includes (Optional Additional Door)



Ray Profilleri / Rail Profiles

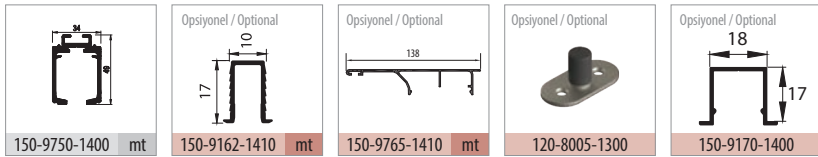

Teknik Detay / Technical Detail

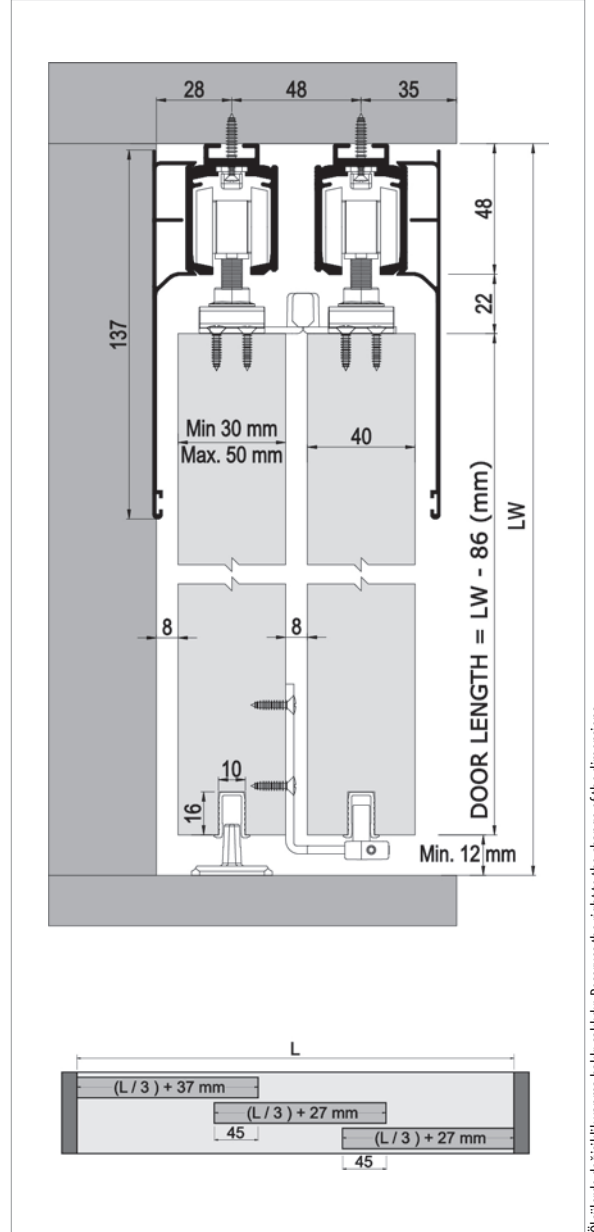

Ölçülerde değişiklik yapma hakkı saklıdır. Reserves the right to the change of the dimensions.

Kod / Code No	Açıklama / Description	Renk / Colour	Birim / Unit			Profil mt. / Profiles mt.	Bağ / Bnd.
127-0102-1600	MultiDoor 102 Teleskopik Sürme Kapı Sistemi / Telescopic Sliding Door System	Gri / Grey	2 Kapı / 1 Set	16	512	- - -	-
127-0101-1600	MultiDoor 101 İlave Kapı Sistemi / Additional Door System	Gri / Grey	1 Kapı / 1 Kit	24	576	- - -	-
150-9750-1400	Alüminyum Üst Ray Profili / Aluminium Top Rail Profile	Pres / Uncoated	mt.	-	-	- - 6,0	2 ad/pcs
150-9162-1410	Alüminyum Alt Klavuz Profili / Aluminium Bottom Slider Profile	Eloksal / Mat Anodized	mt.	-	-	- 3,0 6,0	20 ad/pcs
150-9765-1410	Alüminyum Alın Kapama / Aluminium Cover Front	Eloksal / Mat Anodized	mt.	-	-	2,0 3,0 6,0	2 ad/pcs

MultiDoor 150

127-0150

80 KG AYARLI TELESKOPIK HALATLI SÜRME KAPI SİSTEMİ

80 KG ADJUSTABLE TELESCOPIC FUNICULAR SLIDING DOOR SYSTEMS



Bilgi / Information

- Minimum kapı genişliği 450 mm olmalıdır.
- Min. Door width 450 mm



127-0152 1 Set İçeriği / 1 Set Includes



127-0151 1 Takım İçeriği (Opsiyonel Ek Kapı) / 1 Kit Includes (Optional Additional Door)

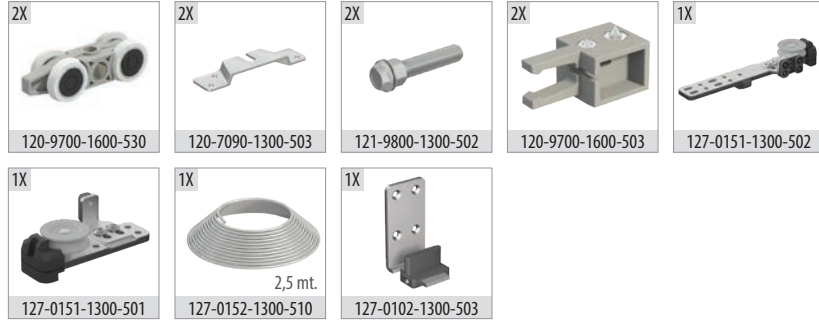

Ray Profilleri / Rail Profiles

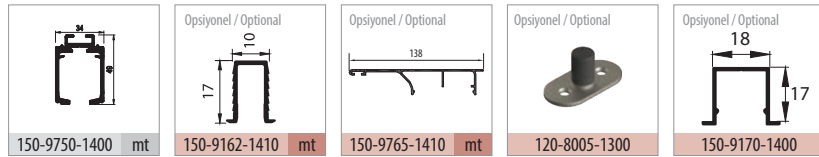

Teknik Detay / Technical Detail

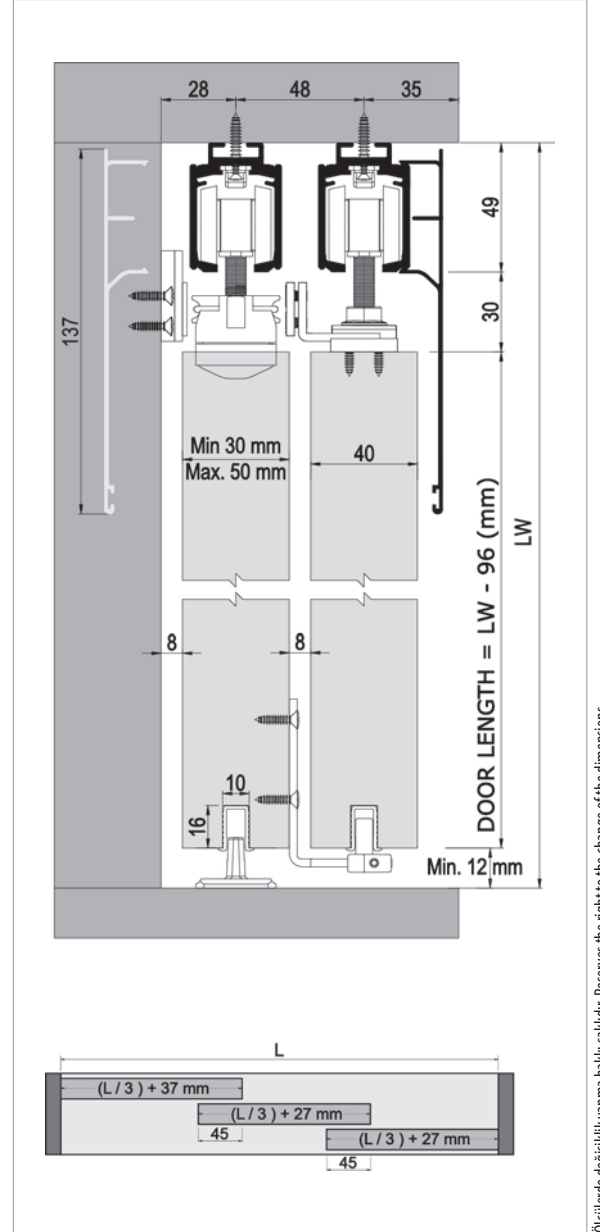

Ölçülerde değişiklik yapma hakkı saklıdır. Reserves the right to the change of the dimensions.

Kod / Code No	Açıklama / Description	Renk / Colour	Birim / Unit			Profil mt. / Profiles mt.	Bağ / Bnd.		
127-0152-1600	MultiDoor 152 Teleskopik Sürme Kapı Sistemi / Telescopic Sliding Door System	Gri / Grey	2 Kapı / 1 Set	12	360	-	-	-	
127-0151-1600	MultiDoor 151 İlave Kapı Sistemi / Additional Door System	Gri / Grey	1 Kapı / 1 Kit	16	512	-	-	-	
127-0152-1300-510	İlave Çelik Halat / Additional Wire Rope	Gri / Grey	mt.	-	-	-	-	-	
150-9750-1400	Alüminyum Üst Ray Profili / Aluminium Top Rail Profile	Pres / Uncoated	mt.	-	-	-	6,0	2 ad/pcs	
150-9162-1410	Alüminyum Alt Klavuz Profili / Aluminium Bottom Slider Profile	Eloksal / Mat Anodized	mt.	-	-	-	3,0	6,0	20 ad/pcs
150-9765-1410	Alüminyum Alın Kapama / Aluminium Cover Front	Eloksal / Mat Anodized	mt.	-	-	2,0	3,0	6,0	2 ad/pcs

MultiDoor 200

127-0200

80 KG AYARLI TEK YÖNE YAVAŞLATICILI TELESKOPİK SÜRME KAPI SİSTEMİ

80 KG ADJUSTABLE TELESCOPIC SLIDING DOOR SYSTEMS - ONE WAY SOFT CLOSING



Bilgi / Information

- Minimum kapı genişliği 620 mm olmalıdır.
- Min. Door width 620 mm

Yavaşlatıcı Alternatifi / Soft Closer Alternative

- Sistem üzerinde tek yöne yavaşlatıcı mevcuttur.
- The system has one way soft closing.



127-0202 1 Set İçeriği / 1 Set Includes



127-0201 1 Takım İçeriği (Opsiyonel Ek Kapı) / 1 Kit Includes (Optional Additional Door)



Ray Profilleri / Rail Profiles

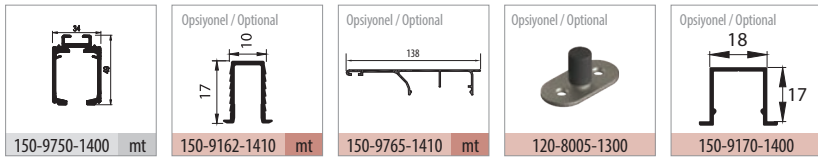

Teknik Detay / Technical Detail

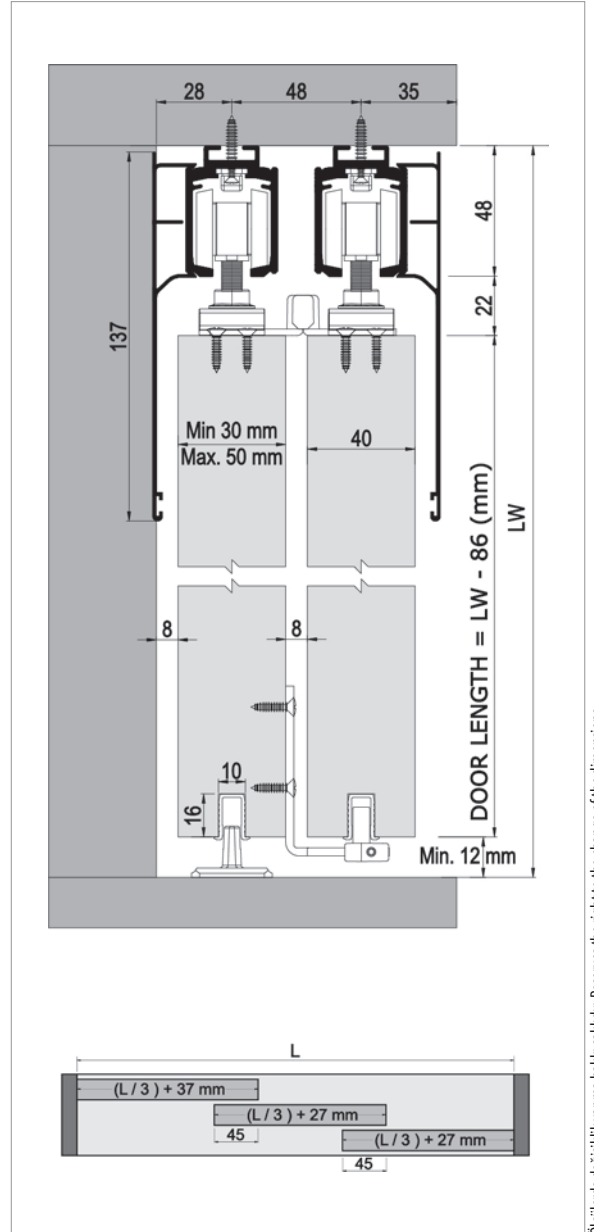

Ölçülerde değişiklik yapma hakkı saklıdır. Reserves the right to the change of the dimensions.

Kod / Code No	Açıklama / Description	Renk / Colour	Birim / Unit			Profil mt. / Profiles mt.	Bağ / Bnd.
127-0202-1600	MultiDoor 202 Teleskopik Sürme Kapı Sistemi / Telescopic Sliding Door System	Gri / Grey	2 Kapı / 1 Set	12	216	- - -	-
127-0201-1600	MultiDoor 201 İlave Kapı Sistemi / Additional Door System	Gri / Grey	1 Kapı / 1 Kit	8	400	- - -	-
150-9750-1400	Alüminyum Üst Ray Profili / Aluminium Top Rail Profile	Pres / Uncoated	mt.	-	-	2,0 3,0 6,0	2 ad/pcs
150-9162-1410	Alüminyum Alt Klavuz Profili / Aluminium Bottom Slider Profile	Eloksal / Mat Anodized	mt.	-	-	- 3,0 6,0	20 ad/pcs
150-9765-1410	Alüminyum Alın Kapama / Aluminium Cover Front	Eloksal / Mat Anodized	mt.	-	-	2,0 3,0 6,0	2 ad/pcs

MultiDoor 250

127-0250

80 KG AYARLI TEK YÖNE YAVAŞLATICILI HALATLI TELESKOPIK SÜRME KAPI SİSTEMİ
80 KG ADJUSTABLE TELESCOPIC FUNICULAR SLIDING DOOR SYSTEMS - ONE WAY SOFT CLOSING



Bilgi / Information

- Minimum kapı genişliği 670 mm olmalıdır.
- Min. Door width 670 mm

Yavaşlatıcı Alternatifi / Soft Closer Alternative

- Sistem üzerinde tek yöne yavaşlatıcı mevcuttur.
- The system has one way soft closing.



127-0252 1 Set İçeriği / 1 Set Includes

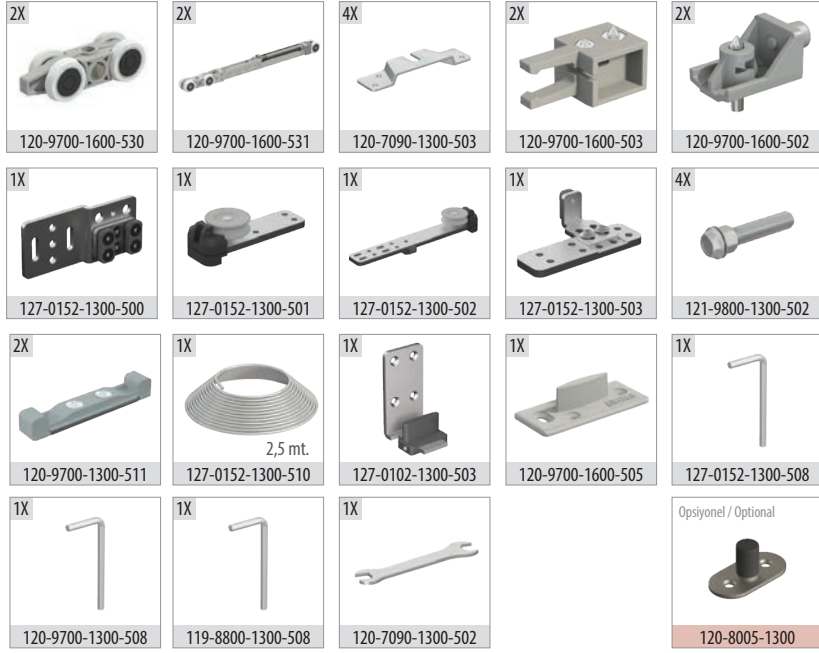

127-0251 1 Takım İçeriği (Opsiyonel Ek Kapı) / 1 Kit Includes (Optional Additional Door)



Ray Profilleri / Rail Profiles

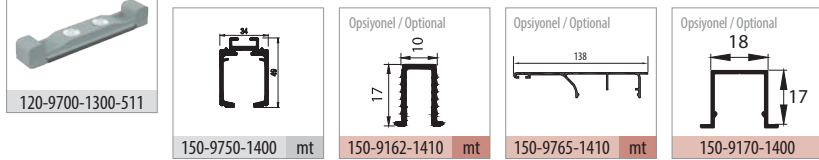

Teknik Detay / Technical Detail

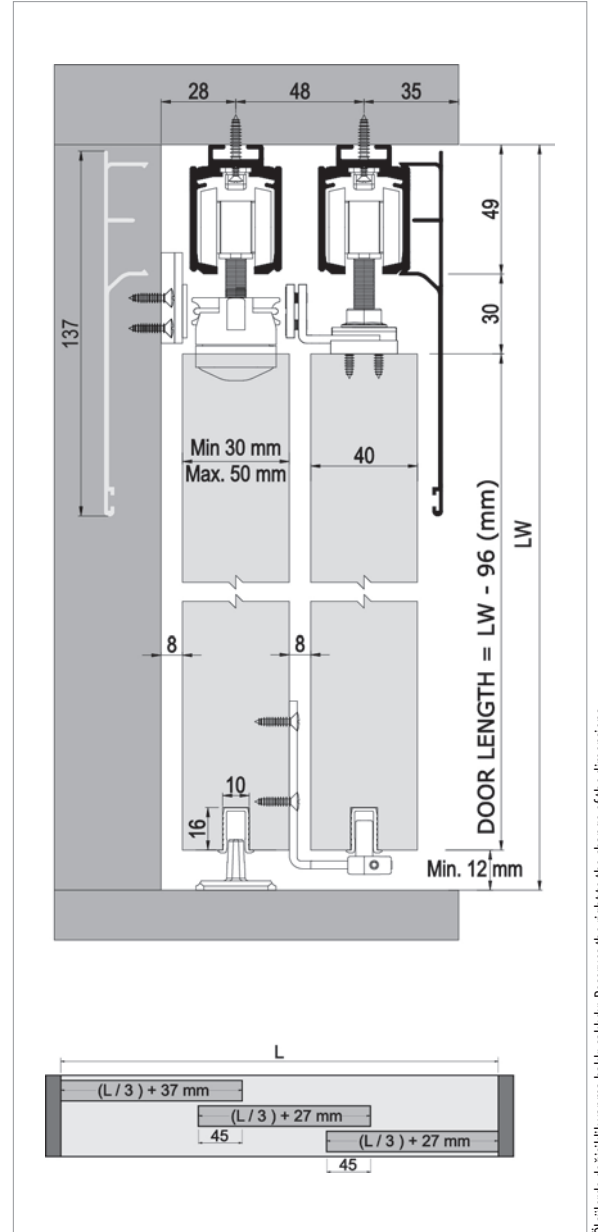

Ölçülerde değişiklik yapma hakkı saklıdır. Reserves the right to the change of the dimensions.

Kod / Code No	Açıklama / Description	Renk / Colour	Birim / Unit			Profil mt. / Profiles mt.	Bağ / Bnd.
127-0252-1600	MultiDoor 252 Teleskopik Sürme Kapı Sistemi / Telescopic Sliding Door System	Gri / Grey	2 Kapı / 1 Set	12	216	-	-
127-0251-1600	MultiDoor 251 İlave Kapı Sistemi / Additional Door System	Gri / Grey	1 Kapı / 1 Kit	8	400	-	-
127-0152-1300-510	İlave Çelik Halat / Additional Wire Rope	Gri / Grey	mt.	-	-	-	-
150-9750-1400	Alüminyum Üst Ray Profili / Aluminium Top Rail Profile	Pres / Uncoated	mt.	-	-	2,0 3,0 6,0	2 ad/pcs
150-9162-1410	Alüminyum Alt Klavuz Profili / Aluminium Bottom Slider Profile	Eloksal / Mat Anodized	mt.	-	-	- 3,0 6,0	20 ad/pcs
150-9765-1410	Alüminyum Alın Kapama / Aluminium Cover Front	Eloksal / Mat Anodized	mt.	-	-	2,0 3,0 6,0	2 ad/pcs



MultiDoor 250

<p>SINCE 1976</p>	 <p>Bearing Systems</p>	<p>EN 1527 100.000 CYCLES TEST</p> 	<p>(R) The Sliding System</p>
-----------------------	---	--	--



MultiDoor 400

127-0400

60 KG AYARLI ÇİFT YÖNE YAVAŞLATICILI TELESKOPİK SÜRME KAPI SİSTEMİ

60 KG ADJUSTABLE TELESCOPIC SLIDING DOOR SYSTEMS - TWO WAY SOFT CLOSING



Bilgi / Information

- Minimum kapı genişliği 770 mm olmalıdır.
- Min. Door width 770 mm

Yavaşlatıcı Alternatifi / Soft Closer Alternative

- Sistem üzerinde çift yöne yavaşlatıcı mevcuttur.
- The system has two way soft closing.



127-0402 1 Set İçeriği / 1 Set Includes



127-0401 1 Takım İçeriği (Opsiyonel Ek Kapı) / 1 Kit Includes (Optional Additional Door)

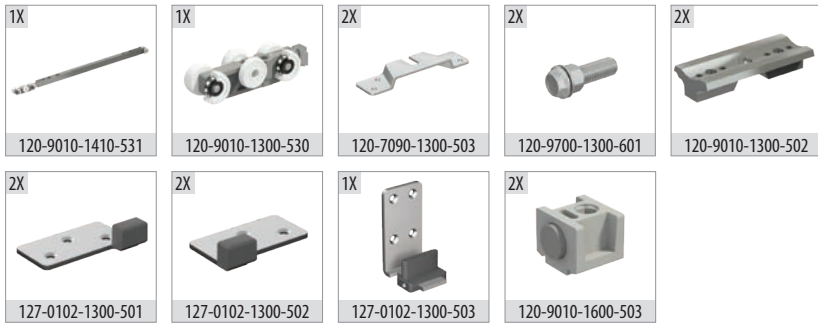

Ray Profilleri / Rail Profiles

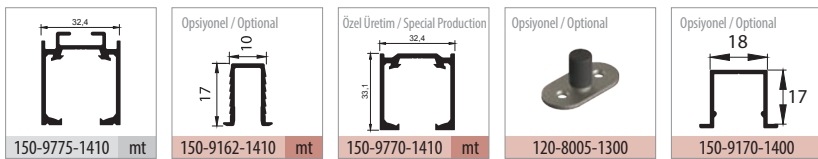

Teknik Detay / Technical Detail

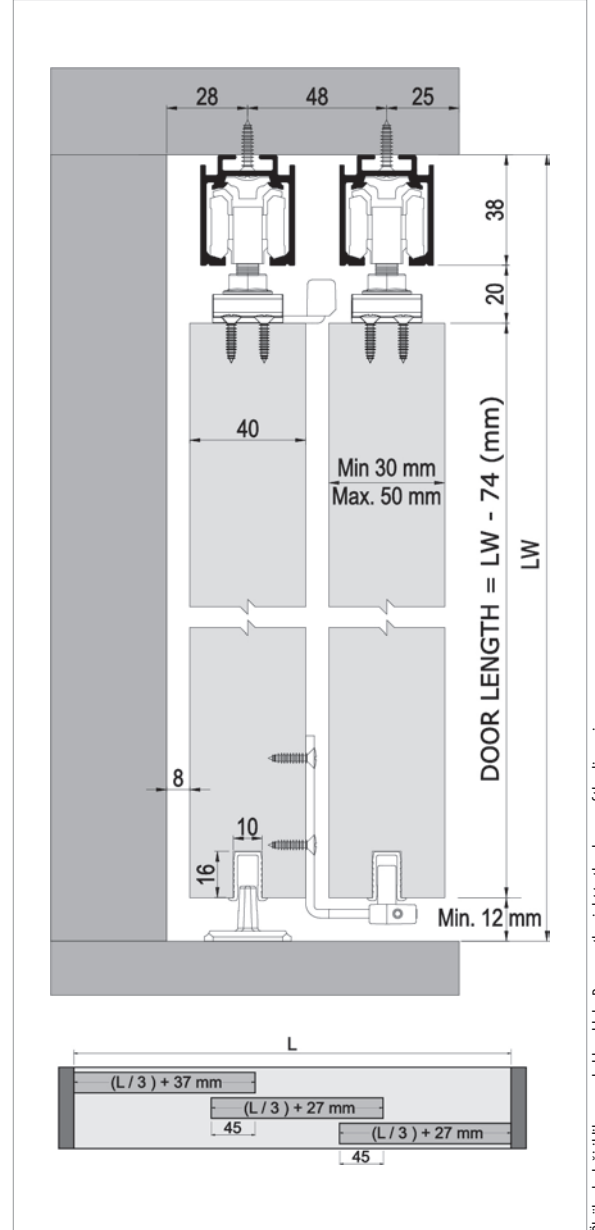

Ölçülerde değişiklik yapma hakkı saklıdır. Reserves the right to the change of the dimensions.

Kod / Code No	Açıklama / Description	Renk / Colour	Birim / Unit			Profil mt. / Profiles mt.	Bağ / Bnd.
127-0402-1410	MultiDoor 402 Teleskopik Sürme Kapı Sistemi / Telescopic Sliding Door System	Gri / Grey	2 Kapı / 1 Set	4	144	-	-
127-0401-1410	MultiDoor 401 İlave Kapı Sistemi / Additional Door System	Gri / Grey	1 Kapı / 1 Kit	4	144	-	-
150-9775-1410	Alüminyum Üst Ray Profili / Aluminium Top Rail Profile	Eloksal / Mat Anodized	mt.	-	-	3,0 4,0 6,0	6 ad/pcs
150-9162-1410	Alüminyum Alt Klavuz Profili / Aluminium Bottom Slider Profile	Eloksal / Mat Anodized	mt.	-	-	- 3,0 6,0	20 ad/pcs
150-9770-1410	Alüminyum Üst Ray Profili / Aluminium Top Rail Profile	Eloksal / Mat Anodized	mt.	-	-	- - 6,0	6 ad/pcs

MultiDoor 450

127-0450

60 KG AYARLI ÇİFT YÖNE YAVAŞLATICILI HALATLI TELESKOPIK SÜRME KAPI SİSTEMİ
60 KG ADJUSTABLE TWO WAY SOFT CLOSING TELESCOPIC SLIDING DOOR SYSTEMS



Bilgi / Information

- Minimum kapı genişliği 810 mm olmalıdır.
- Min. Door width 810 mm

Yavaşlatıcı Alternatifi / Soft Closer Alternative

- Sistem üzerinde çift yöne yavaşlatıcı mevcuttur.
- The system has two way soft closing.



127-0452 1 Set İçeriği / 1 Set Includes



127-0451 1 Takım İçeriği (Opsiyonel Ek Kapı) / 1 Kit Includes (Optional Additional Door)

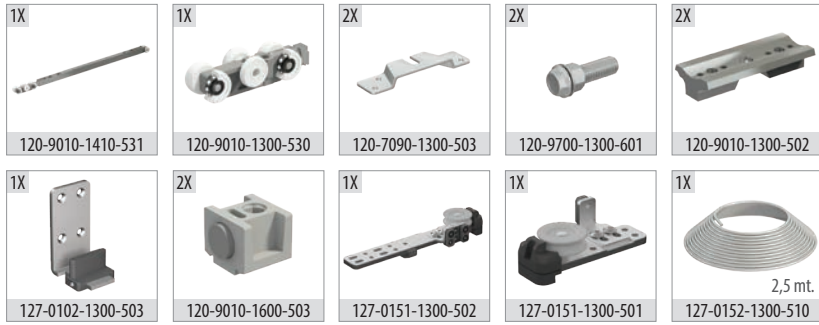

Ray Profilleri / Rail Profiles

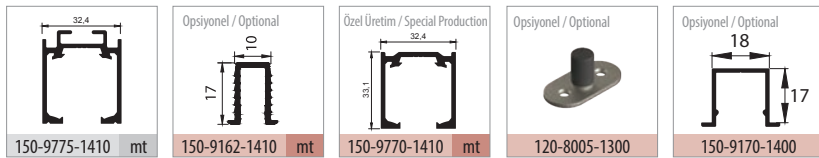

Teknik Detay / Technical Detail

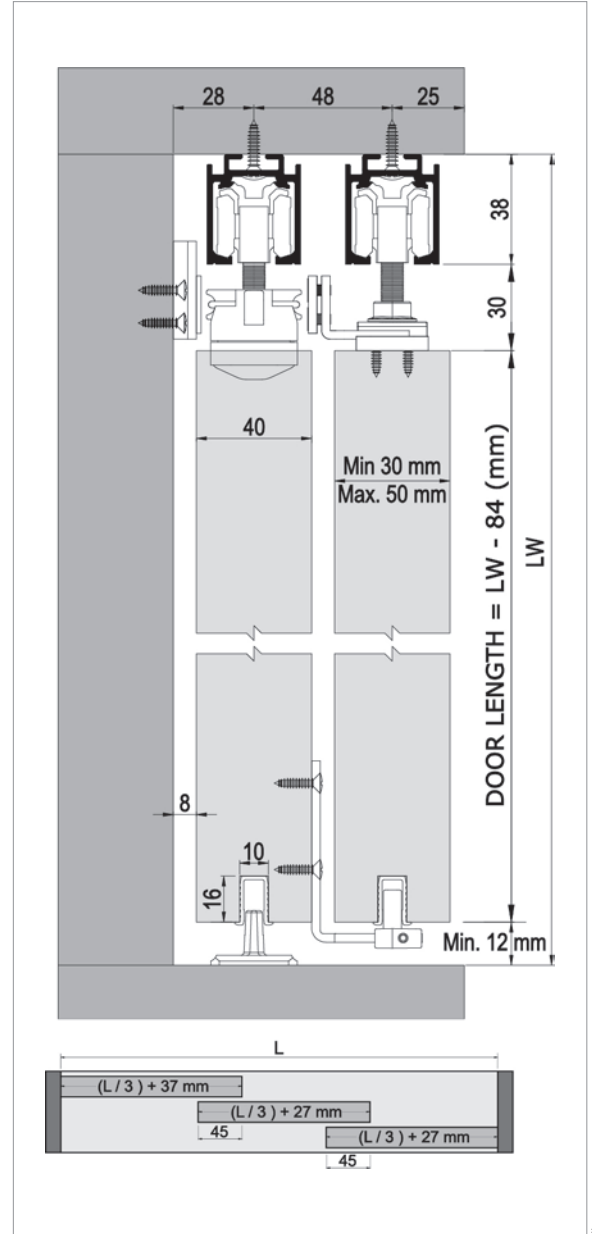

Ölçülerde değişiklik yapma hakkı saklıdır. Reserves the right to the change of the dimensions.

Kod / Code No	Açıklama / Description	Renk / Colour	Birim / Unit			Profil mt. / Profiles mt.	Bağ / Bnd.
127-0452-1410	MultiDoor 452 Teleskopik Sürme Kapı Sistemi / Telescopic Sliding Door System	Gri / Grey	2 Kapı / 1 Set	4	144	-	-
127-0451-1410	MultiDoor 451 İlave Kapı Sistemi / Additional Door System	Gri / Grey	1 Kapı / 1 Kit	4	144	-	-
127-0152-1300-510	İlave Çelik Halat / Additional Wire Rope	Gri / Grey	mt.	-	-	-	-
150-9775-1410	Alüminyum Üst Ray Profili / Aluminium Top Rail Profile	Eloksal / Mat Anodized	mt.	-	-	3,0 4,0 6,0	6 ad/pcs
150-9162-1410	Alüminyum Alt Klavuz Profili / Aluminium Bottom Slider Profile	Eloksal / Mat Anodized	mt.	-	-	- 3,0 6,0	20 ad/pcs
150-9770-1410	Alüminyum Üst Ray Profili / Aluminium Top Rail Profile	Eloksal / Mat Anodized	mt.	-	-	- - 6,0	6 ad/pcs

MultiDoor 500

127-0500

120 KG AYARLI ÇİFT YÖNE YAVAŞLATICILI HALATLI TELESKOPIK SÜRME KAPI SİSTEMİ
120 KG ADJUSTABLE TWO WAY SOFT CLOSING TELESCOPIC SLIDING DOOR SYSTEMS

Yeni Ürün
New Product



Bilgi / Information

- Minimum kapı genişliği 765 mm olmalıdır.
- Min. Door width 765 mm

Yavaşlatıcı Alternatifi / Soft Closer Alternative

- Sistem üzerinde çift yöne yavaşlatıcı mevcuttur.
- The system has two way soft closing.



127-0502 1 Set İçeriği / 1 Set Includes



127-0501 1 Takım İçeriği (Opsiyonel Ek Kapı) / 1 Kit Includes (Optional Additional Door)



Ray Profilleri / Rail Profiles

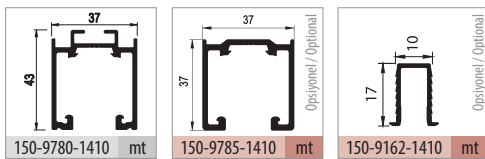

Teknik Detay / Technical Detail

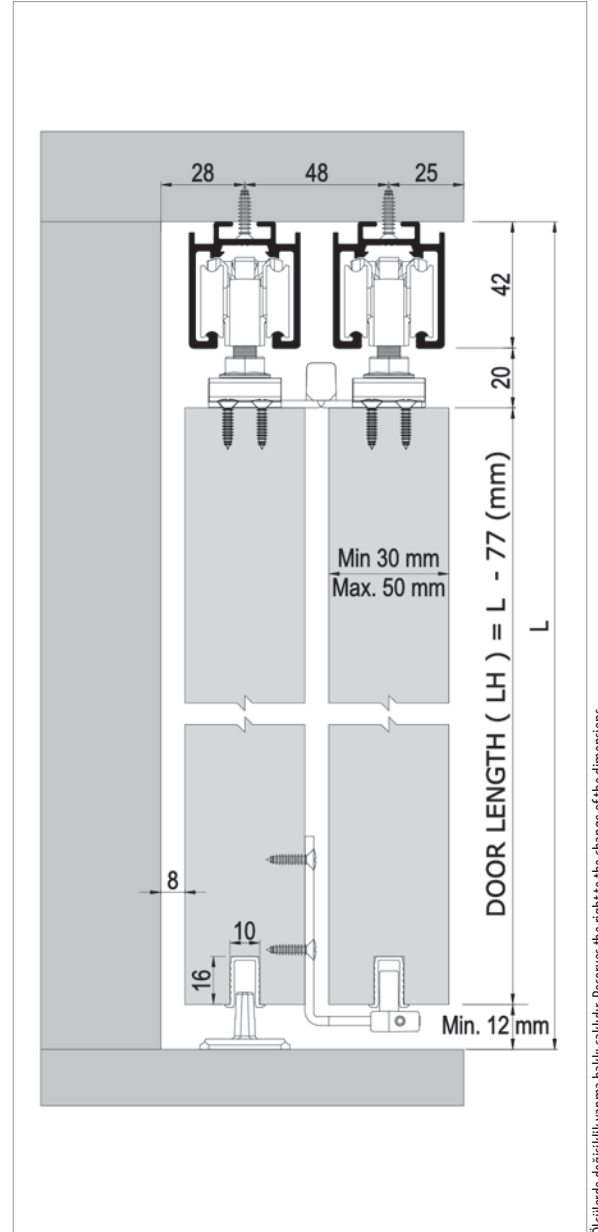

Ölçülerde değişiklik yapma hakkı saklıdır. Reserves the right to the change of the dimensions.

Kod / Code No	Açıklama / Description	Renk / Colour	Birim / Unit			Profil mt. / Profiles mt.	Bağ / Bnd.		
127-0502-1410	MultiDoor 502 Teleskopik Sürme Kapı Sistemi / Telescopic Sliding Door System	Gri / Grey	2 Kapı / 1 Set	4	144	-	-	-	
127-0501-1410	MultiDoor 501 İlave Kapı Sistemi / Additional Door System	Gri / Grey	1 Kapı / 1 Kit	4	144	-	-	-	
127-0152-1300-510	İlave Çelik Halat / Additional Wire Rope	Gri / Grey	mt.	-	-	-	-	-	
150-9780-1410	Alüminyum Üst Ray Profili / Aluminium Top Rail Profile	Eloksal / Mat Anodized	mt.	-	-	3,0	4,0	6,0	6 ad/pcs
150-9785-1410	Alüminyum Üst Ray Profili / Aluminium Top Rail Profile	Eloksal / Mat Anodized	mt.	-	-	3,0	4,0	6,0	6 ad/pcs
150-9162-1410	Alüminyum Alt Klavuz Profili / Aluminium Bottom Slider Profile	Eloksal / Mat Anodized	mt.	-	-	-	3,0	6,0	20 ad/pcs

MultiDoor 550

127-0550

120 KG AYARLI ÇİFT YÖNE YAVAŞLATICILI HALATLI TELESKOPİK SÜRME KAPI SİSTEMİ
120 KG ADJUSTABLE TELESCOPIC FUNICULAR SLIDING DOOR SYSTEMS - TWO WAY SOFT

Yeni Ürün
New Product



Bilgi / Information

- Minimum kapı genişliği 790 mm olmalıdır.
- Min. Door width 790 mm

Yavaşlatıcı Alternatifi / Soft Closer Alternative

- Sistem üzerinde çift yöne yavaşlatıcı mevcuttur.
- The system has two way soft closing.



127-0552 1 Set İçeriği / 1 Set Includes



127-0551 1 Takım İçeriği (Opsiyonel Ek Kapı) / 1 Kit Includes (Optional Additional Door)

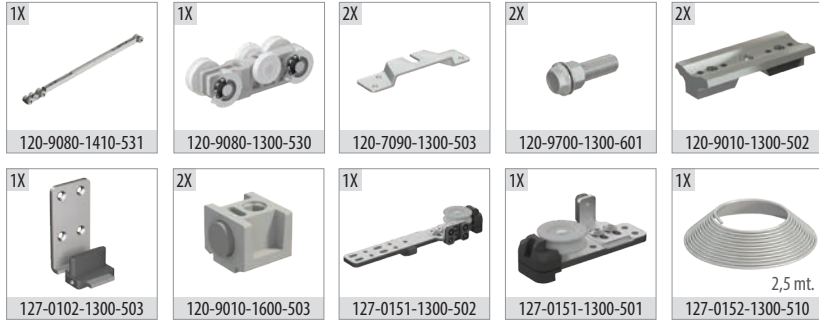

Ray Profilleri / Rail Profiles

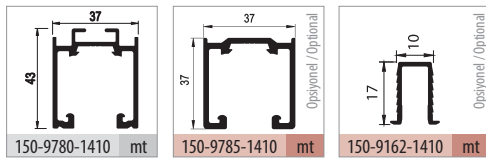

Teknik Detay / Technical Detail

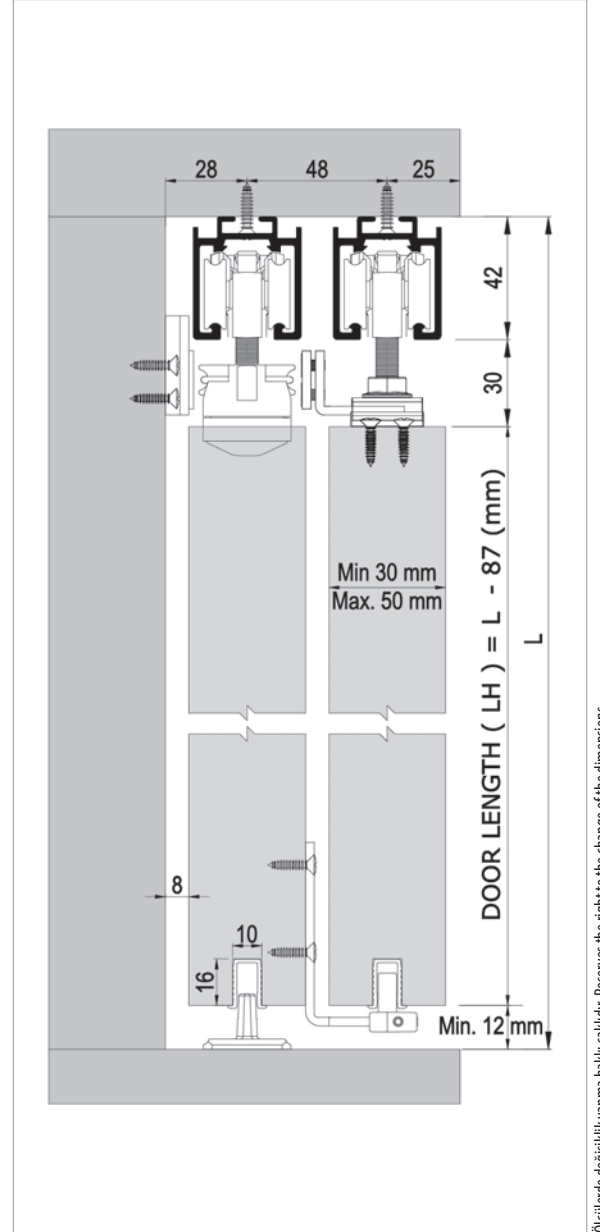

Kod / Code No	Açıklama / Description	Renk / Colour	Birim / Unit			Profil mt. / Profiles mt.	Bağ / Bnd.
127-0552-1410	MultiDoor 552 Teleskopik Sürme Kapı Sistemi / Telescopic Sliding Door System	Gri / Grey	2 Kapı / 1 Set	4	144	-	-
127-0551-1410	MultiDoor 551 İlave Kapı Sistemi / Additional Door System	Gri / Grey	1 Kapı / 1 Kit	4	144	-	-
127-0152-1300-510	İlave Çelik Halat / Additional Wire Rope	Gri / Grey	mt.	-	-	-	-
150-9780-1410	Alüminyum Üst Ray Profili / Aluminium Top Rail Profile	Eloksal / Mat Anodized	mt.	-	-	3,0 4,0 6,0	6 ad/pcs
150-9785-1410	Alüminyum Üst Ray Profili / Aluminium Top Rail Profile	Eloksal / Mat Anodized	mt.	-	-	3,0 4,0 6,0	6 ad/pcs
150-9162-1410	Alüminyum Alt Klavuz Profili / Aluminium Bottom Slider Profile	Eloksal / Mat Anodized	mt.	-	-	3,0 6,0	20 ad/pcs

Group 130

Underline[®]

Kapı Altı Giyotin Serisi
Door Seal Series

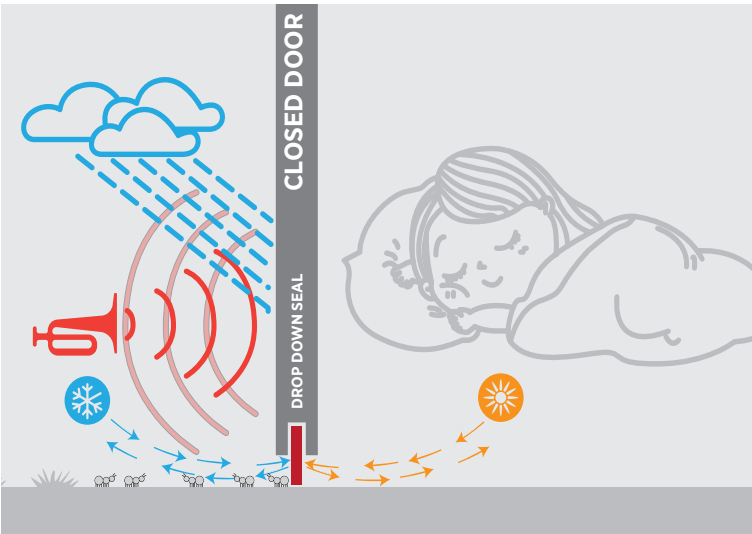
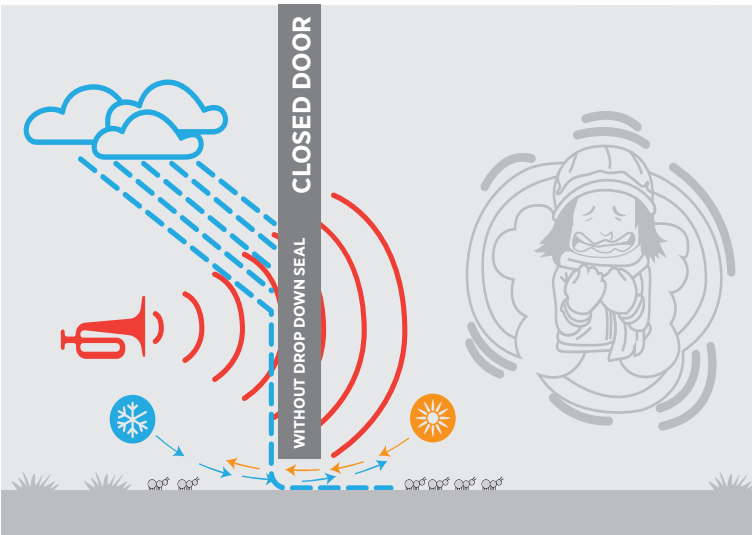

Bu serideki tüm ürünleri incelemek için QR kodu okutabilirsiniz.

You can analyze the QR code to see all the products in these series.



Underline Series

SINCE 1976	 Bearing Systems	EN 1527 100.000 CYCLES TEST 	 The Sliding System
---------------	------------------------	--	------------------------------



	OEM Kod OEM Code	Ürün Kodu Product Code	Kesit Ölçüsü Cross Section Size	Yangın Dayanım Fire Protection	Kesilebilir (mm) Shortened Up	Kapatma Mesafesi Closing Distance	Standart Renk Standard Colour
1	130-0200	Underline 200	13 - 35 mm		10 cm	0 - 20 mm	Eloksal / Mat Anodized
2	130-0210	Underline 210	13 - 35 mm	✓	10 cm	0 - 20 mm	Eloksal / Mat Anodized
3	130-0220	Underline 220	15 - 49 mm		10 cm	0 - 20 mm	Eloksal / Mat Anodized
4	130-0230	Underline 230	17- 49 mm	✓	10 cm	0 - 20 mm	Eloksal / Mat Anodized
5	130-0300	Underline 300	12 - 20 mm		20 cm	0 - 13 mm	Eloksal / Mat Anodized

- Verilen ölçüler bağlayıcı değildir. Önerilen kurulum ölçüleridir. Albatır ürün özelliklerinde haber vermeden değişiklik yapabilir.
- The given dimension are not binding. These are recommended asamble dimensions. Albatır can make alteration to product specification without notice.

1



130-0200

2



130-0210

3

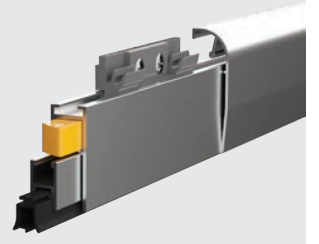

130-0220

4



130-0230

5



130-0300

6

7

8

9

10

11

12

Underline 200

130-0200

KAPI ALTI GIYOTİNİ
DOOR SEAL-INTERNAL



Bilgi / Information

- 0'dan 20 mm alt açıklığa kadar kapatabilme imkanı sunar.
 - Mekanizma baskı ayarı yapılabilir.
 - 10 cm. kadar kısaltma yapılabilir.
 - Özel ölçü için lütfen müşteri temsilciniz ile irtibata geçiniz.
 - Özel üretimlerde Minimum 200 adet sipariş kabul edilir.
- Usable for 0 - 20 mm drop
 - Pressure can be adjusted
 - Shortened up to 10 cm.
 - Custom sizes, please contact your customer representative.
 - Minimum 200 pcs orders are accepted in for special manufacturers.



Teknik Detay / Technical Detail

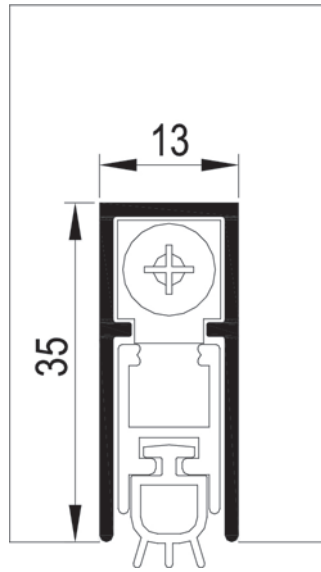

Ölçülerde değişiklik yapma hakkı saklıdır. Reserves the right to the change of the dimensions.

Kod / Code No	Açıklama / Description	Renk / Colour	Boy / Size (mm)	Birim / Unit		
130-0200-1410-0530	Kapı Altı Giyotini / Door Seal - Internal	Eloksal / Mat Anodized	530 mm	1 Adet / 1 Pcs	10	360
130-0200-1410-0830	Kapı Altı Giyotini / Door Seal - Internal	Eloksal / Mat Anodized	830 mm	1 Adet / 1 Pcs	10	360
130-0200-1410-0930	Kapı Altı Giyotini / Door Seal - Internal	Eloksal / Mat Anodized	930 mm	1 Adet / 1 Pcs	10	360
130-0200-1410-1030	Kapı Altı Giyotini / Door Seal - Internal	Eloksal / Mat Anodized	1.030 mm	1 Adet / 1 Pcs	10	360
130-0200-1410-1130	Kapı Altı Giyotini / Door Seal - Internal	Eloksal / Mat Anodized	1.130 mm	1 Adet / 1 Pcs	10	360
130-0200-1410-1230	Kapı Altı Giyotini / Door Seal - Internal	Eloksal / Mat Anodized	1.230 mm	1 Adet / 1 Pcs	10	360

Underline 220

130-0220

KAPI ALTI GIYOTINI-DIŞTAN
DOOR SEAL-EXTERNAL

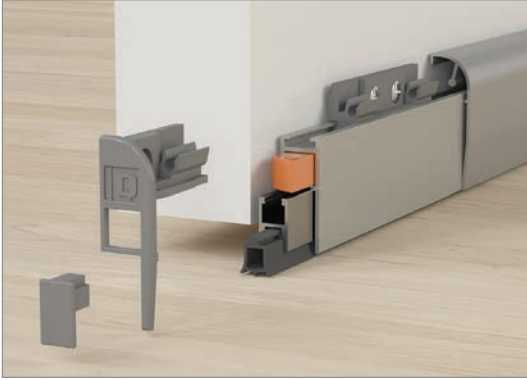

Bilgi / Information



- Tüm ahşap ve alüminyum kapı detaylarında kullanılabilir.
 - 0'dan 20 mm alt açıklığa kadar kapatabilme imkanı sunar.
 - Mekanizma baskı ayarı yapılabilir.
 - 10 cm. kadar kısaltma yapılabilir.
 - Özel ölçü için lütfen müşteri temsilciniz ile iletişime geçiniz.
 - Özel üretimlerde Minimum 200 adet sipariş kabul edilir.
- Usable for wooden and aluminium doors
 - Usable for 0 - 20 mm drop
 - Pressure can be adjusted
 - Shortened up to 10 cm.
 - Custom sizes, please contact your customer representative.
 - Minimum 200 pcs orders are accepted in for special manufacturers.

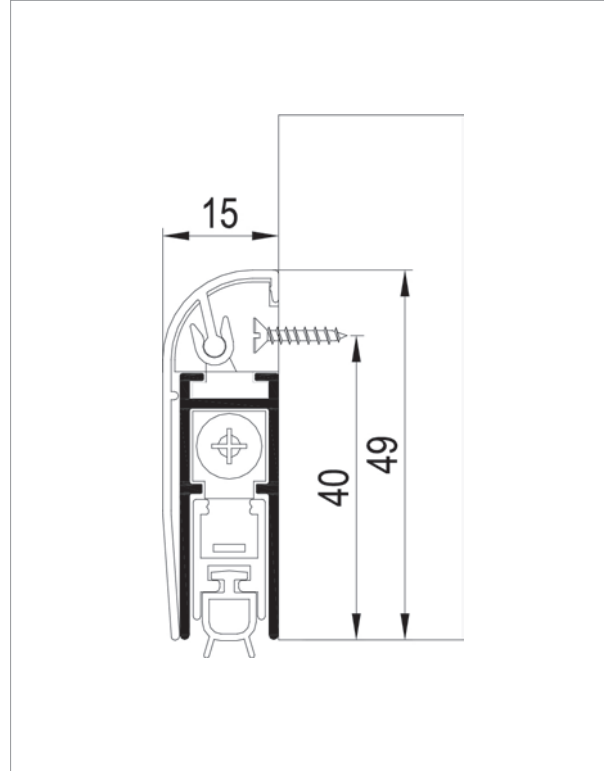

Teknik Detay / Technical Detail



Ölçülerde değişiklik yapma hakkı saklıdır. Reserves the right to the change of the dimensions.

Kod / Code No	Açıklama / Description	Renk / Colour	Boy / Size (mm)	Birim / Unit		
130-0220-1410-0530	Kapı Altı Giyotini - Dıştan / Door Seal - External	Eloksal / Mat Anodized	530 mm	1 Adet / 1 Pcs	10	360
130-0220-1410-0830	Kapı Altı Giyotini - Dıştan / Door Seal - External	Eloksal / Mat Anodized	830 mm	1 Adet / 1 Pcs	10	360
130-0220-1410-0930	Kapı Altı Giyotini - Dıştan / Door Seal - External	Eloksal / Mat Anodized	930 mm	1 Adet / 1 Pcs	10	360
130-0220-1410-1030	Kapı Altı Giyotini - Dıştan / Door Seal - External	Eloksal / Mat Anodized	1.030 mm	1 Adet / 1 Pcs	10	360
130-0220-1410-1130	Kapı Altı Giyotini - Dıştan / Door Seal - External	Eloksal / Mat Anodized	1.130 mm	1 Adet / 1 Pcs	10	360
130-0220-1410-1230	Kapı Altı Giyotini - Dıştan / Door Seal - External	Eloksal / Mat Anodized	1.230 mm	1 Adet / 1 Pcs	10	360

Underline 230

130-0230

YANGINA DAYANIMLI KAPI ALTI GIYOTINI - DIŞTAN
DOOR SEAL FIRE PROTECTION-EXTERNAL

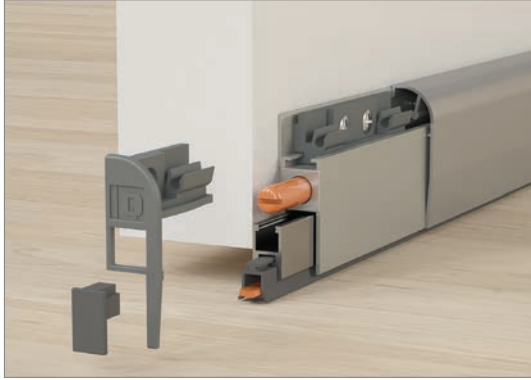

Bilgi / Information

- Tüm ahşap ve alüminyum kapı detaylarında kullanılabilir.
- 0'dan 20 mm alt açıklığa kadar kapatılma imkanı sunar.
- Mekanizma baskı ayarı yapılabilir.
- 10 cm. kadar kısaltma yapılabilir.
- Özel ölçü için lütfen müşteri temsilciniz ile irtibata geçiniz.
- Özel üretimlerde Minimum 200 adet sipariş kabul edilir.
- Usable for wooden and aluminium doors
- Usable for 0 - 20 mm drop
- Pressure can be adjusted
- Shortened up to 10 cm.
- Custom sizes, please contact your customer representative.
- Minimum 200 pcs orders are accepted in for special manufacturers.



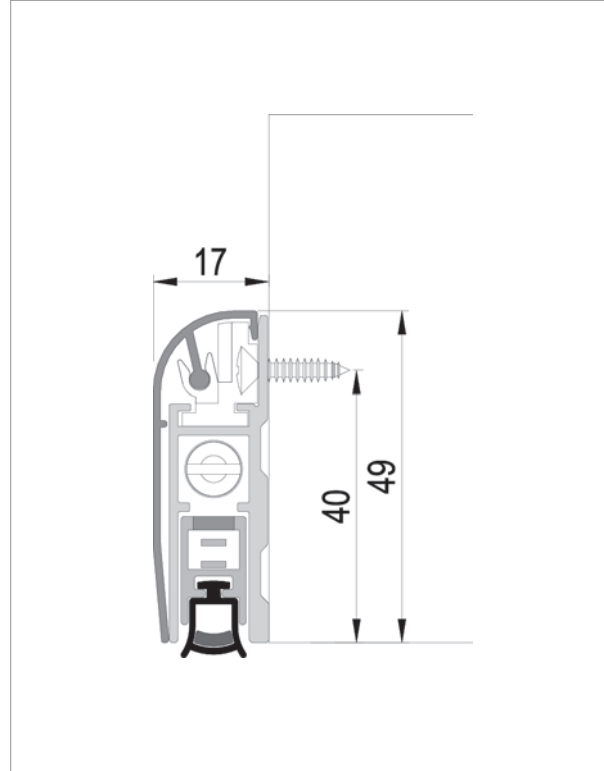

Teknik Detay / Technical Detail



Ölçülerde değişiklik yapma hakkı saklıdır. Reserves the right to the change of the dimensions.



Yangın Dayanım Sertifikası / Fire Resistance Certificate

Kod / Code No	Açıklama / Description	Renk / Colour	Boy / Size (mm)	Birim / Unit		
130-0230-1410-0830	Yangına Dayanımlı Kapı Altı Giyotini-Dıştan / Door Seal (Fire Protection)- External	Eloksal / Mat Anodized	830 mm	1 Adet / 1 Pcs	10	360
130-0230-1410-0930	Yangına Dayanımlı Kapı Altı Giyotini-Dıştan / Door Seal (Fire Protection)- External	Eloksal / Mat Anodized	930 mm	1 Adet / 1 Pcs	10	360
130-0230-1410-1030	Yangına Dayanımlı Kapı Altı Giyotini-Dıştan / Door Seal (Fire Protection)- External	Eloksal / Mat Anodized	1.030 mm	1 Adet / 1 Pcs	10	360
130-0230-1410-1130	Yangına Dayanımlı Kapı Altı Giyotini-Dıştan / Door Seal (Fire Protection)- External	Eloksal / Mat Anodized	1.130 mm	1 Adet / 1 Pcs	10	360
130-0230-1410-1230	Yangına Dayanımlı Kapı Altı Giyotini-Dıştan / Door Seal (Fire Protection)- External	Eloksal / Mat Anodized	1.230 mm	1 Adet / 1 Pcs	10	360



Bilgi / Information

- Tüm ahşap ve alüminyum kapı detaylarında kullanılabilir.
- 0'dan 13 mm alt açıklığa kadar kapatabilme imkanı sunar.
- Mekanizma baskı ayarı yapılabilir.
- 20 cm. kadar kısaltma yapılabilir.
- Özel ölçü için lütfen müşteri temsilciniz ile iletişime geçiniz.
- Özel üretimlerde minimum 200 adet sipariş kabul edilir.
- Usable for wooden and aluminium doors
- Usable for 0 - 13 mm drop
- Pressure can be adjusted
- Shortened up to 20 cm.
- Custom sizes, please contact your customer representative.
- Minimum 200 pcs orders are accepted in for special manufacturers.

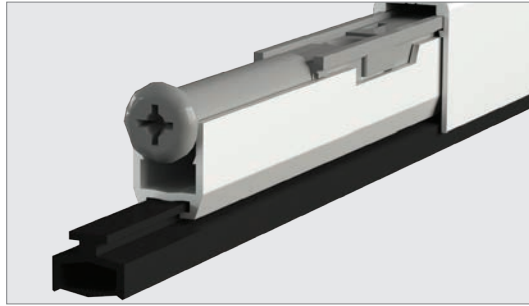

Teknik Detay / Technical Detail

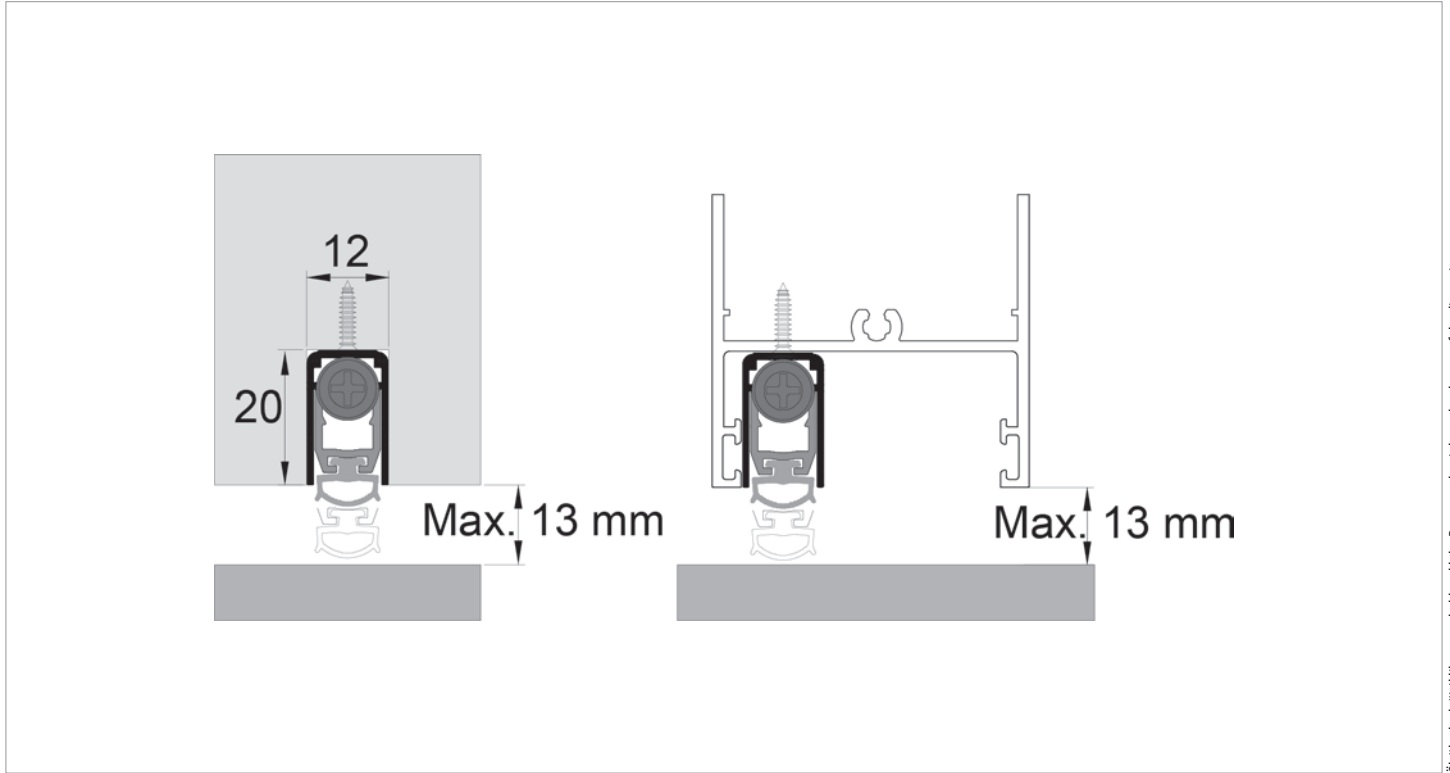

Ölçülerde değişiklik yapma hakkı saklıdır. Reserves the right to the change of the dimensions.

Kod / Code No	Açıklama / Description	Renk / Colour	Boy / Size (mm)	Birim / Unit		
130-0300-1410-0460	Underline 300 - Kapı Altı Giyotini / Door Seal - Internal	Eloksal / Mat Anodized	460 mm	1 Adet / 1 Pcs	10	360
130-0300-1410-0630	Underline 300 - Kapı Altı Giyotini / Door Seal - Internal	Eloksal / Mat Anodized	630 mm	1 Adet / 1 Pcs	10	360
130-0300-1410-0830	Underline 300 - Kapı Altı Giyotini / Door Seal - Internal	Eloksal / Mat Anodized	830 mm	1 Adet / 1 Pcs	10	360
130-0300-1410-1030	Underline 300 - Kapı Altı Giyotini / Door Seal - Internal	Eloksal / Mat Anodized	1.030 mm	1 Adet / 1 Pcs	10	360
130-0300-1410-1230	Underline 300 - Kapı Altı Giyotini / Door Seal - Internal	Eloksal / Mat Anodized	1.230 mm	1 Adet / 1 Pcs	10	360



Underline 200

SINCE 1976

 **Bearing Systems**

EN 1527
100.000
CYCLES
TEST



R
The Sliding System



Group 131

Door Hardware

Kapı Donanımları

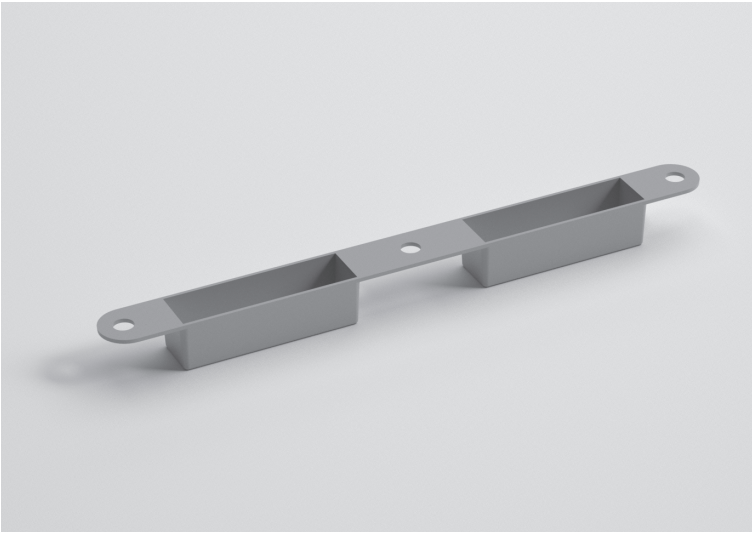

Bu serideki tüm ürünleri incelemek için QR kodu okutabilirsiniz.

You can analyze the QR code to see all the products in these series.

1



131-0100

2



131-0110

3

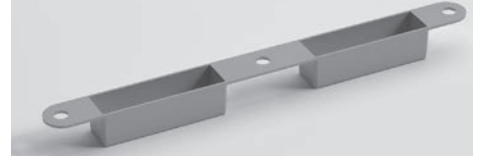

131-0120

4

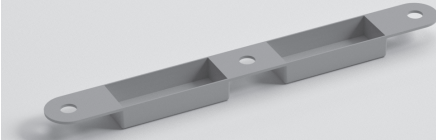

131-0130

5



131-0200

6



131-0210

7



122-9300-1410-507

8

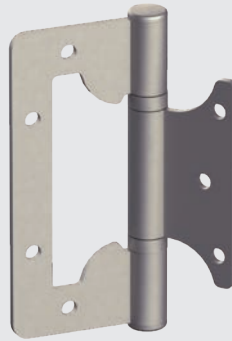

122-9061-1300-505

9

10

11

12

Kapı Donanımları

131-0100

KİLİT KARŞILIĞI CEBİ
LOCK POCKET

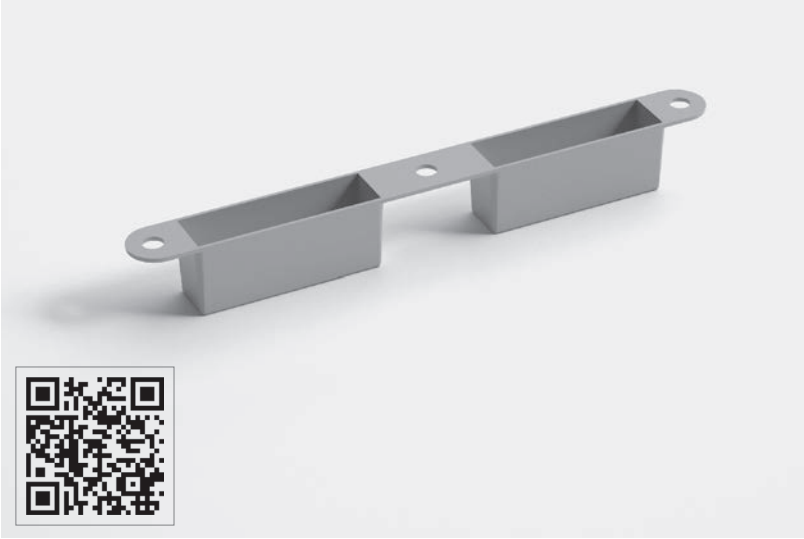

Teknik Detay / Technical Detail

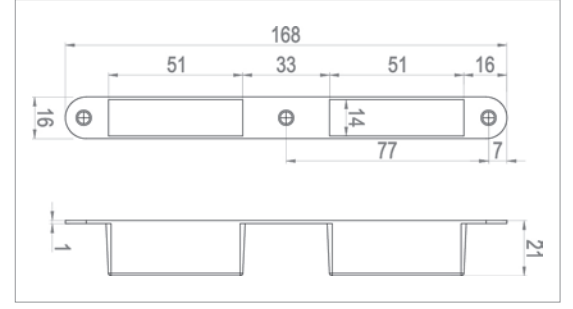

Bilgi / Information

- Ahşap kapılarda kilit karşılığının altındaki detayı kapatmak amacı ile kullanılır.
- Kullanımda olan kilit DIN normlarına uygundur.
- It is used to cover the detail below the strike plate on wooden doors.
- The lock in use conforms to DIN standards.

Kod / Code No	Açıklama / Description	Renk / Colour	Birim / Unit		
131-0100-1660	Kilit Karşılığı Cebi / Lock Pocket	Krem / Cream	1 Adet / 1 Pcs	100	6.000
131-0100-1650	Kilit Karşılığı Cebi / Lock Pocket	Beyaz / White	1 Adet / 1 Pcs	100	6.000
131-0100-1670	Kilit Karşılığı Cebi / Lock Pocket	Kahve / Brown	1 Adet / 1 Pcs	100	6.000
131-0100-1600	Kilit Karşılığı Cebi / Lock Pocket	Gri / Grey	1 Adet / 1 Pcs	100	6.000

Kapı Donanımları

131-0110

KİLİT KARŞILIĞI CEBİ
LOCK POCKET

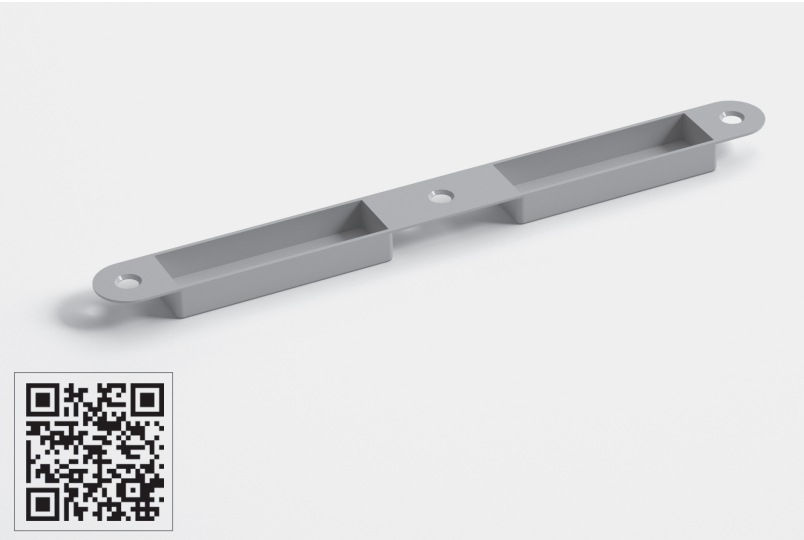

Teknik Detay / Technical Detail

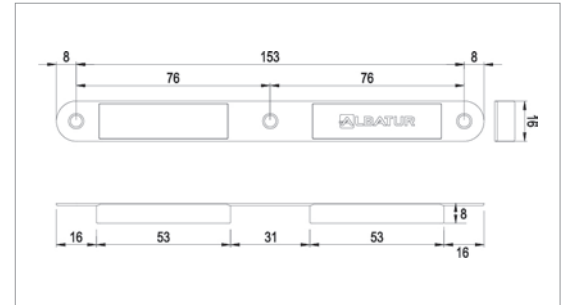

Bilgi / Information

- Ahşap kapılarda kilit karşılığının altındaki detayı kapatmak amacı ile kullanılır.
- Kullanımda olan kilit DIN normlarına uygundur.
- It is used to cover the detail below the strike plate on wooden doors.
- The lock in use conforms to DIN standards.

Kod / Code No	Açıklama / Description	Renk / Colour	Birim / Unit		
131-0110-1660	Kilit Karşılığı Cebi / Lock Pocket	Krem / Cream	1 Adet / 1 Pcs	100	6.000
131-0110-1650	Kilit Karşılığı Cebi / Lock Pocket	Beyaz / White	1 Adet / 1 Pcs	100	6.000
131-0110-1670	Kilit Karşılığı Cebi / Lock Pocket	Kahve / Brown	1 Adet / 1 Pcs	100	6.000

Kapı Donanımları

131-0120

KİLİT KARŞILIĞI CEBİ
LOCK POCKET

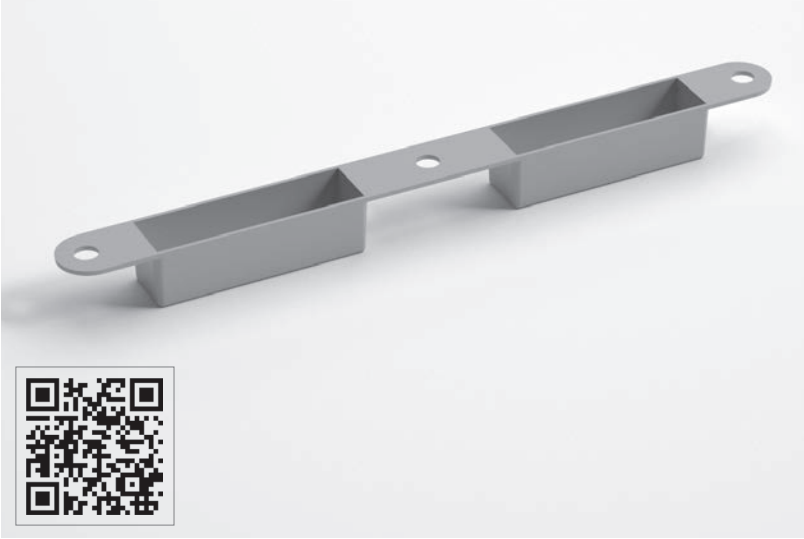

Teknik Detay / Technical Detail

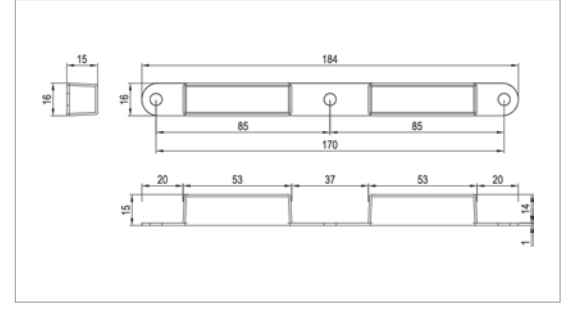

Bilgi / Information

- Ahşap kapılarda kilit karşılığının altındaki detayı kapatmak amacı ile kullanılır.
- Kullanımda olan kilit DIN normlarına uygundur.
- It is used to cover the detail below the strike plate on wooden doors.
- The lock in use conforms to DIN standards.

Kod / Code No	Açıklama / Description	Renk / Colour	Birim / Unit		
131-0120-1600	Kilit Karşılığı Cebi / Lock Pocket	Gri / Grey	1 Adet / 1 Pcs	100	6.000

Kapı Donanımları

131-0130

KİLİT KARŞILIĞI CEBİ
LOCK POCKET

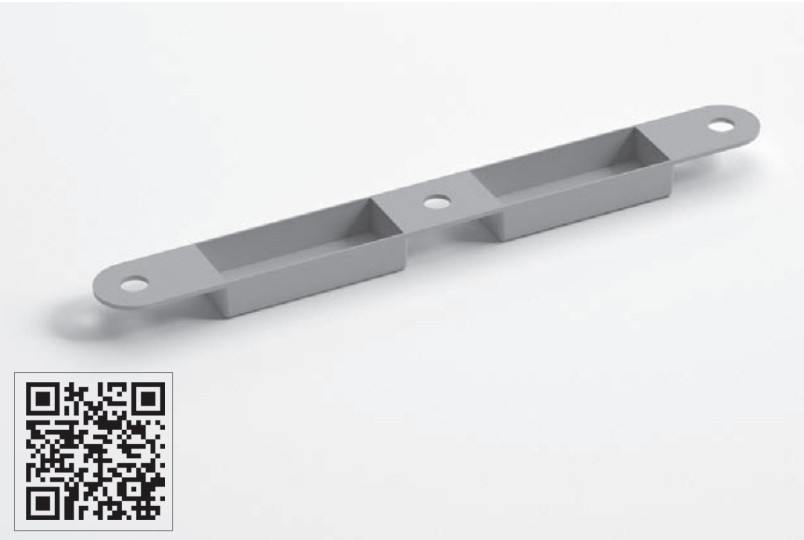

Teknik Detay / Technical Detail

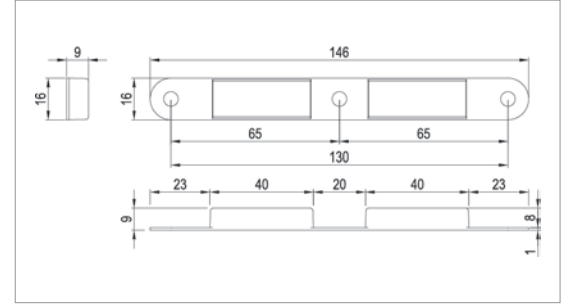

Bilgi / Information

- Ahşap kapılarda kilit karşılığının altındaki detayı kapatmak amacı ile kullanılır.
- Kullanımda olan kilit DIN normlarına uygundur.
- It is used to cover the detail below the strike plate on wooden doors.
- The lock in use conforms to DIN standards.

Kod / Code No	Açıklama / Description	Renk / Colour	Birim / Unit		
131-0130-1600	Kilit Karşılığı Cebi / Lock Pocket	Gri / Grey	1 Adet / 1 Pcs	100	6.000

Kapı Donanımları

131-0200

OTOMATİK KAPI SÜRGÜSÜ (YÖNSÜZ)
AUTOMATIC DOOR BOLT (NONDIRECTIONAL)

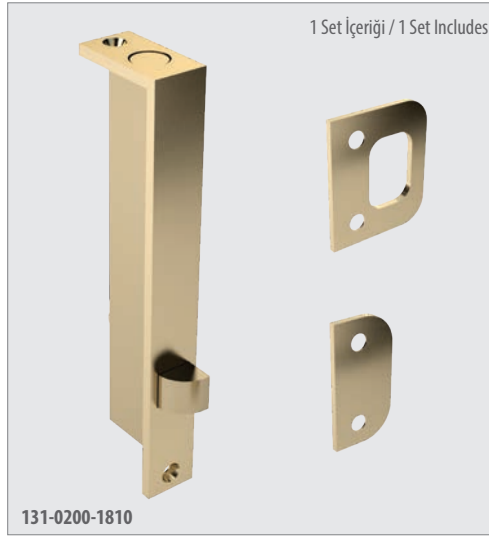

Teknik Detay / Technical Detail

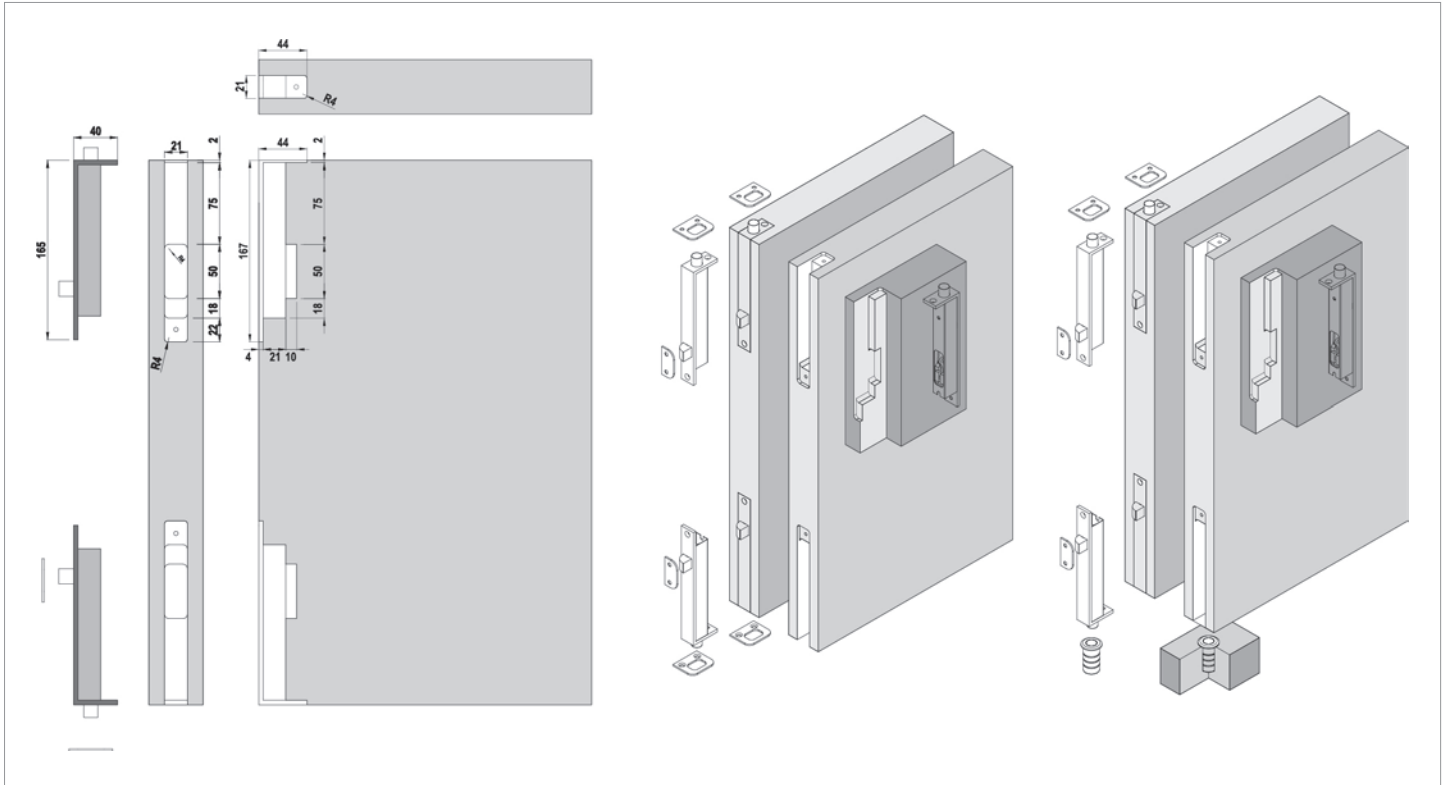

Kod / Code No	Açıklama / Description	Renk / Colour	Birim / Unit		
131-0200-1810	Otomatik Kapı Sürgüsü (Yönsüz) / Automatic Door Bolt (Nondirectional)	Altın / Gold	1 Adet / 1 Pcs	24	480
131-0200-1820	Otomatik Kapı Sürgüsü (Yönsüz) / Automatic Door Bolt (Nondirectional)	Saten / Satin	1 Adet / 1 Pcs	24	480

Kapı Donanımları

131-0210

YER SOKETİ
DUST PROOF STRIKE

1 Set İçeriği / 1 Set Includes



131-0210-1820

1 Set İçeriği / 1 Set Includes





131-0210-1810

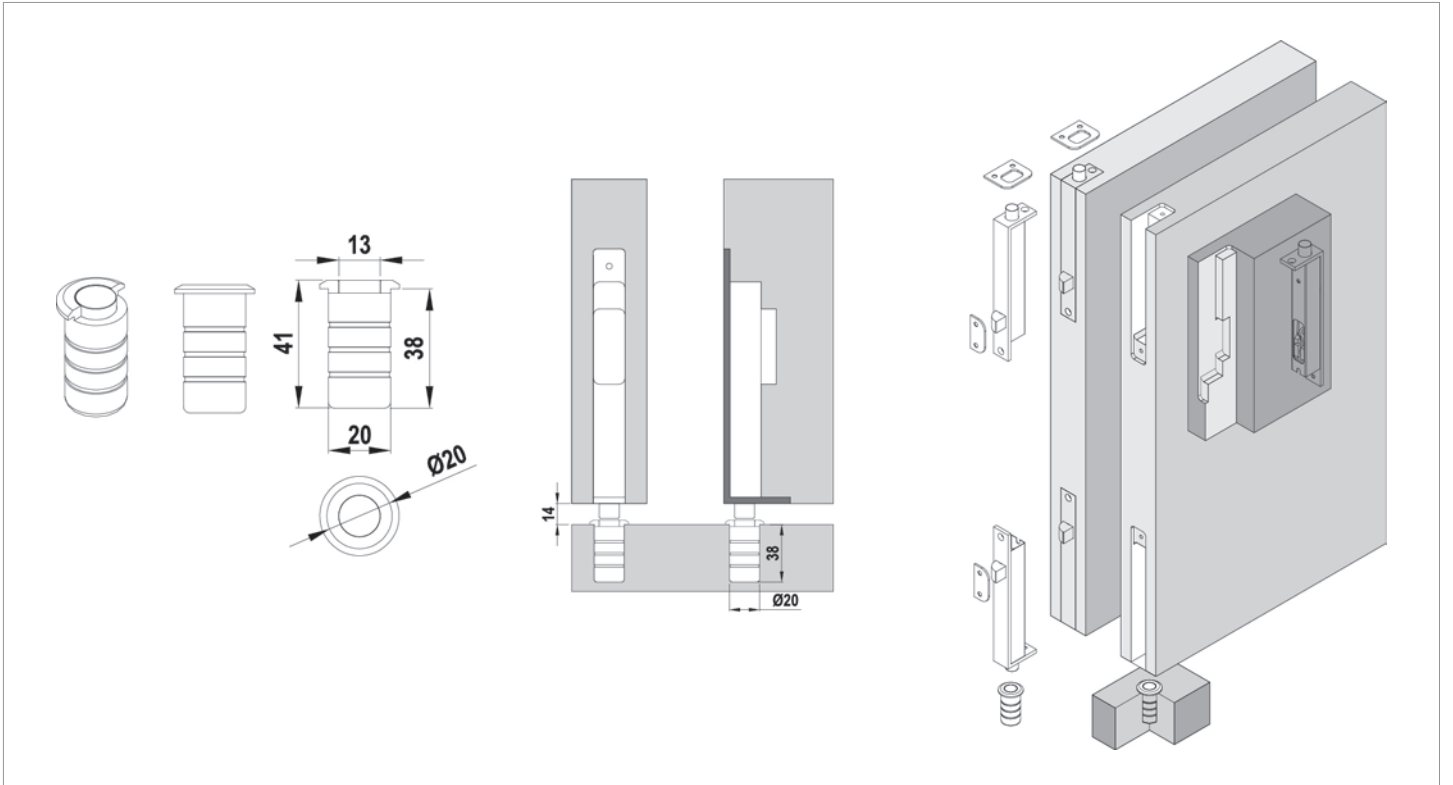

Teknik Detay / Technical Detail



Kod / Code No	Açıklama / Description	Renk / Colour	Birim / Unit		
131-0210-1810	Yer Soketi • Dust Proof Strike	Altın / Gold	1 Adet / 1 Pcs	24	480
131-0210-1820	Yer Soketi • Dust Proof Strike	Saten / Satin	1 Adet / 1 Pcs	24	480

Group 135

MagicLift[®]

Gardırop Donanımları Serisi

Wardrobe Equipments Series



Bu serideki tüm ürünleri incelemek için QR kodu okutabilirsiniz.

You can analyze the QR code to see all the products in these series.

1



135-1100

2



135-1110

3



135-1101

4



135-1200

5

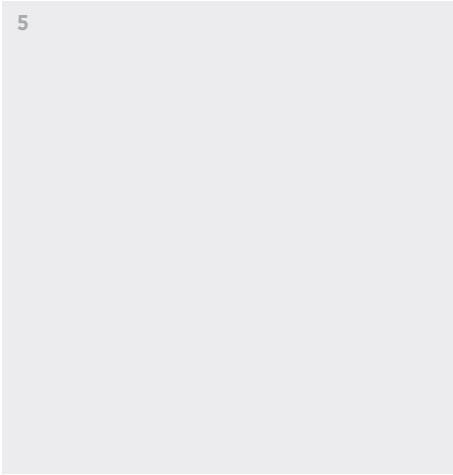

6



7

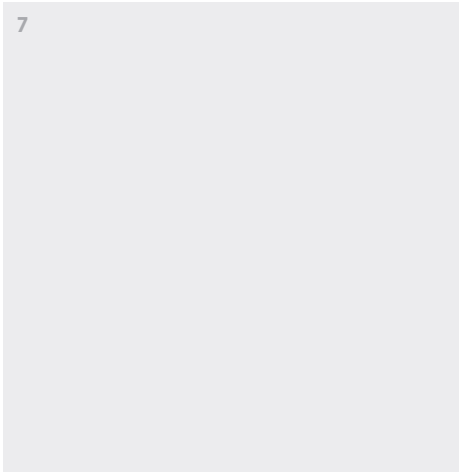

8

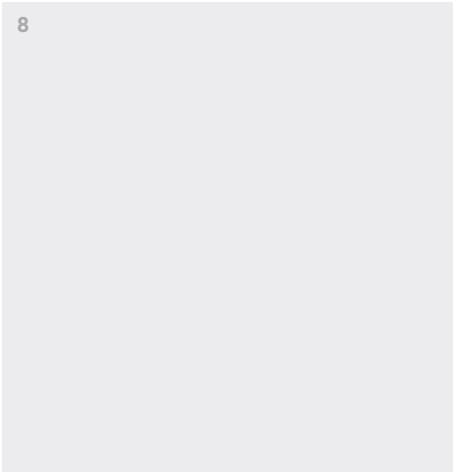

9



10

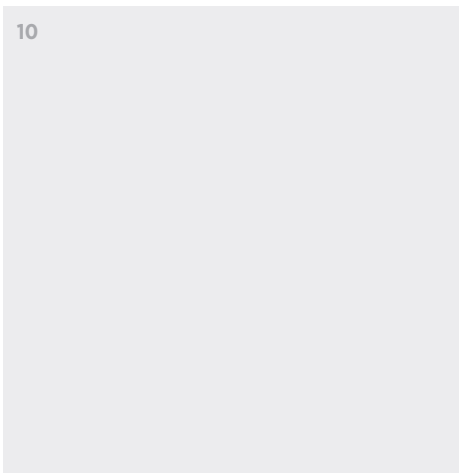

11

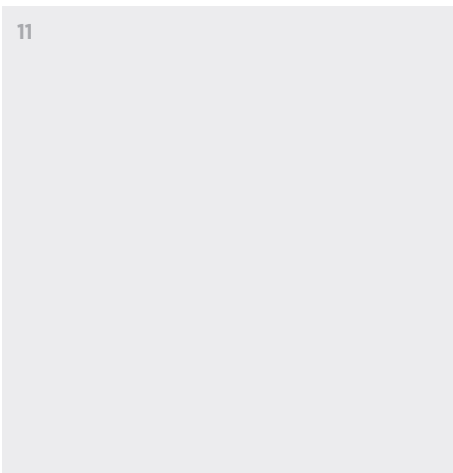

12

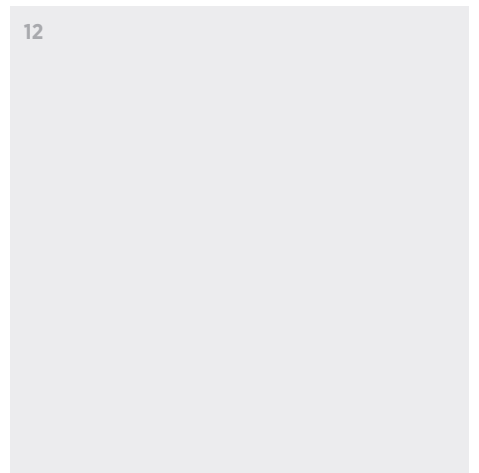

MagicLift 1100

135-1100

15 KG GARDIROP ASANSÖRÜ

15 KG LIFT FOR WARDROBE



OIL
DAMPER



■ Bilgi / Information

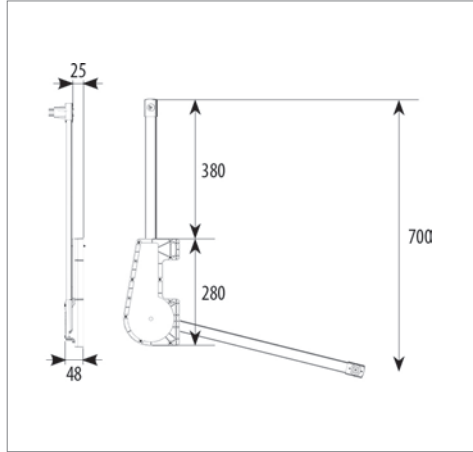

Ölçülerde değişiklik yapma hakkı saklıdır. Reserves the right to the change of the dimensions.

Kod / Code No	Açıklama / Description	Renk / Colour	Birim / Unit		
135-1100-3610	MagicLift 15 Kg - Gardirop asansörü / Lift For Wardrobe	Gri / Grey	1 Adet / 1 Pcs	6	72
135-1100-3620	MagicLift 15 Kg - Gardirop asansörü / Lift For Wardrobe	Antrasit / Anthracite	1 Adet / 1 Pcs	6	72

MagicLift 1110

135-1110

10 KG GARDIROP ASANSÖRÜ
10 KG LIFT FOR WARDROBE

Özel Üretim
Special Production

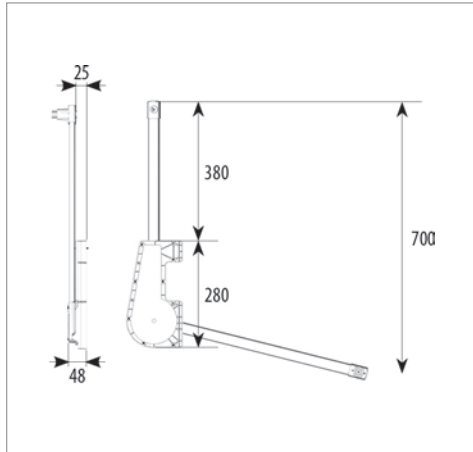
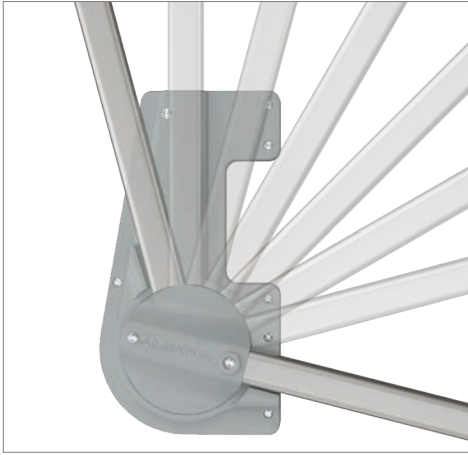

■ Bilgi / Information

Öçülerde deęişiklik yapma hakkı saklıdır. Reserves the right to the change of the dimensions.

Kod / Code No	Açıklama / Description	Renk / Colour	Birim / Unit		
135-1110-3610	MagicLift 10 Kg - Gardirop asansörü / Lift For Wardrobe	Gri / Grey	1 Adet / 1 Pcs	6	72
135-1110-3620	MagicLift 10 Kg - Gardirop asansörü / Lift For Wardrobe	Antrasit / Anthracite	1 Adet / 1 Pcs	6	72



Kod / Code No	Açıklama / Description	Renk / Colour	Birim / Unit		
135-1101-3610	Gardırop Asansörü Montaj Aparatı • Lift For Wardrobe Assembly Kit	Gri / Grey	1 Adet / 1 Pcs	6	72
135-1101-3620	Gardırop Asansörü Montaj Aparatı • Lift For Wardrobe Assembly Kit	Antrasit / Anthracite	1 Adet / 1 Pcs	6	72



Magicalift 1100

<p>SINCE 1976</p>	 <p>Bearing Systems</p>	<p>EN 1527 100.000 CYCLES TEST</p> 	 <p>The Sliding System</p>
-----------------------	--	--	---



MagicLift 1200

135-1200

12 KG GARDIROP ASANSÖRÜ

12 KG LIFT FOR WARDROBE

Yeni Ürün
New Product



OIL
DAMPER

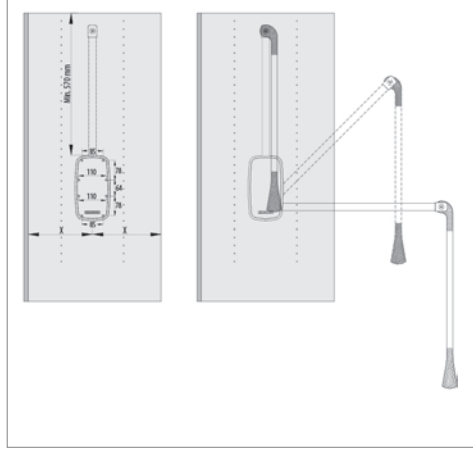
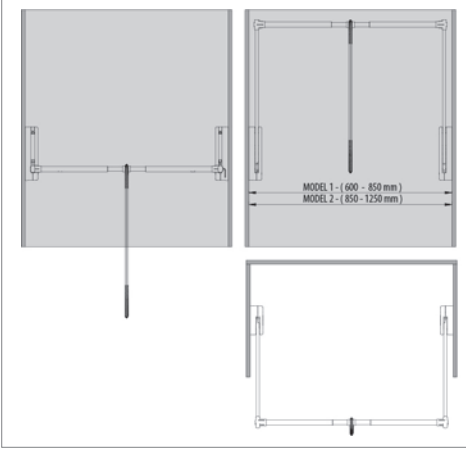

Bilgi / Information

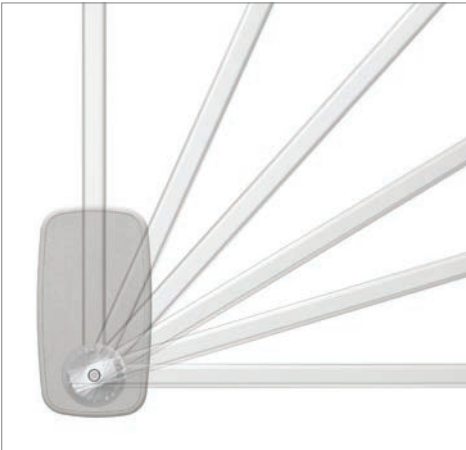
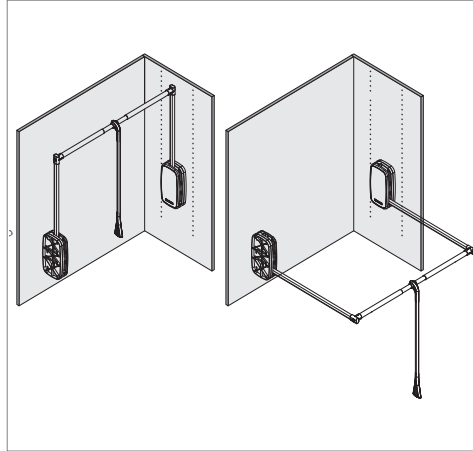
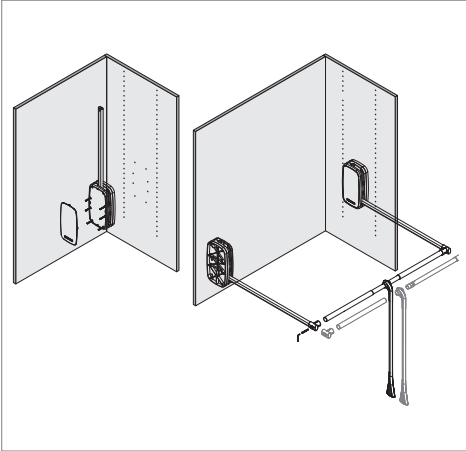

Ölülerde değişiklik yapma hakkı saklıdır. Reserves the right to the change of the dimensions.

Kod / Code No	Açıklama / Description	Renk / Colour	Birim / Unit		
135-1200-3610	MagicLift 12 Kg - Gardirop asansörü / Lift For Wardrobe	Gri / Grey	1 Adet / 1 Pcs	6	72
135-1200-3620	MagicLift 12 Kg - Gardirop asansörü / Lift For Wardrobe	Antrasit / Anthracite	1 Adet / 1 Pcs	6	72



Magicalift 1200

<p>SINCE 1976</p>	 <p>Bearing Systems</p>	<p>EN 1527 100.000 CYCLES TEST</p> 	<p>R</p> <p>The Sliding System</p>
-----------------------	--	--	---



Group 140

Ventil[®] Aluminium

Alüminyum Dekoratif Menfez Serisi

Aluminium Air Ventilation Cover Series

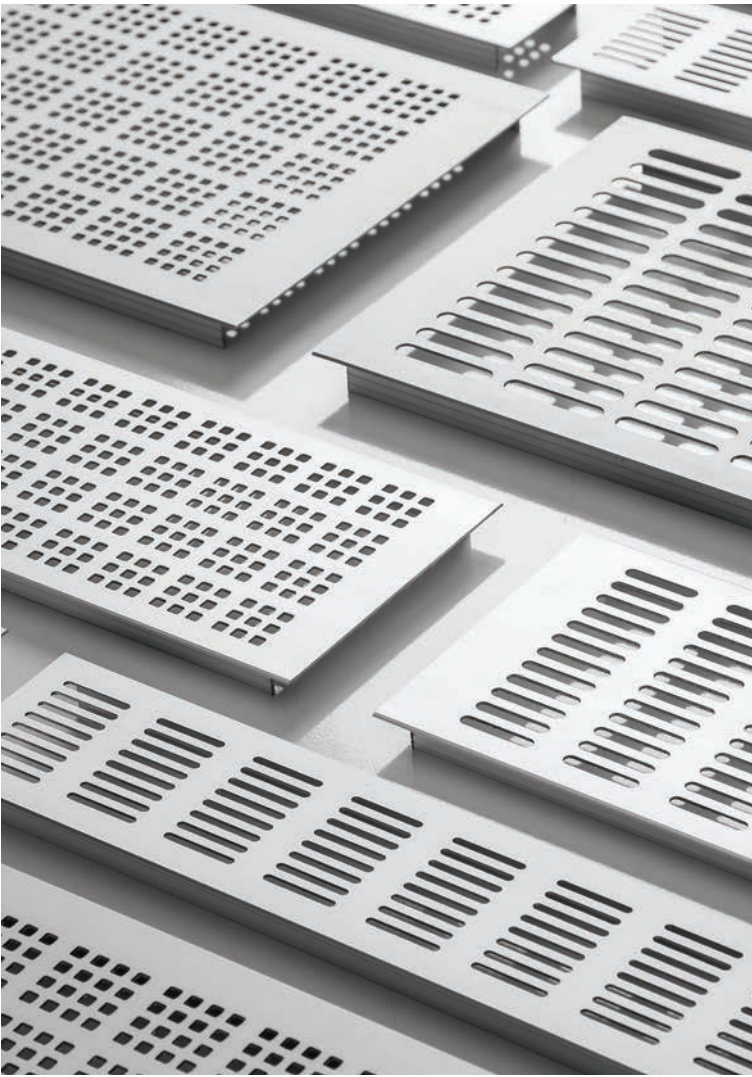

Bu serideki tüm ürünleri incelemek için
QR kodu okutabilirsiniz.

You can analyze the QR code to see all the
products in these series.

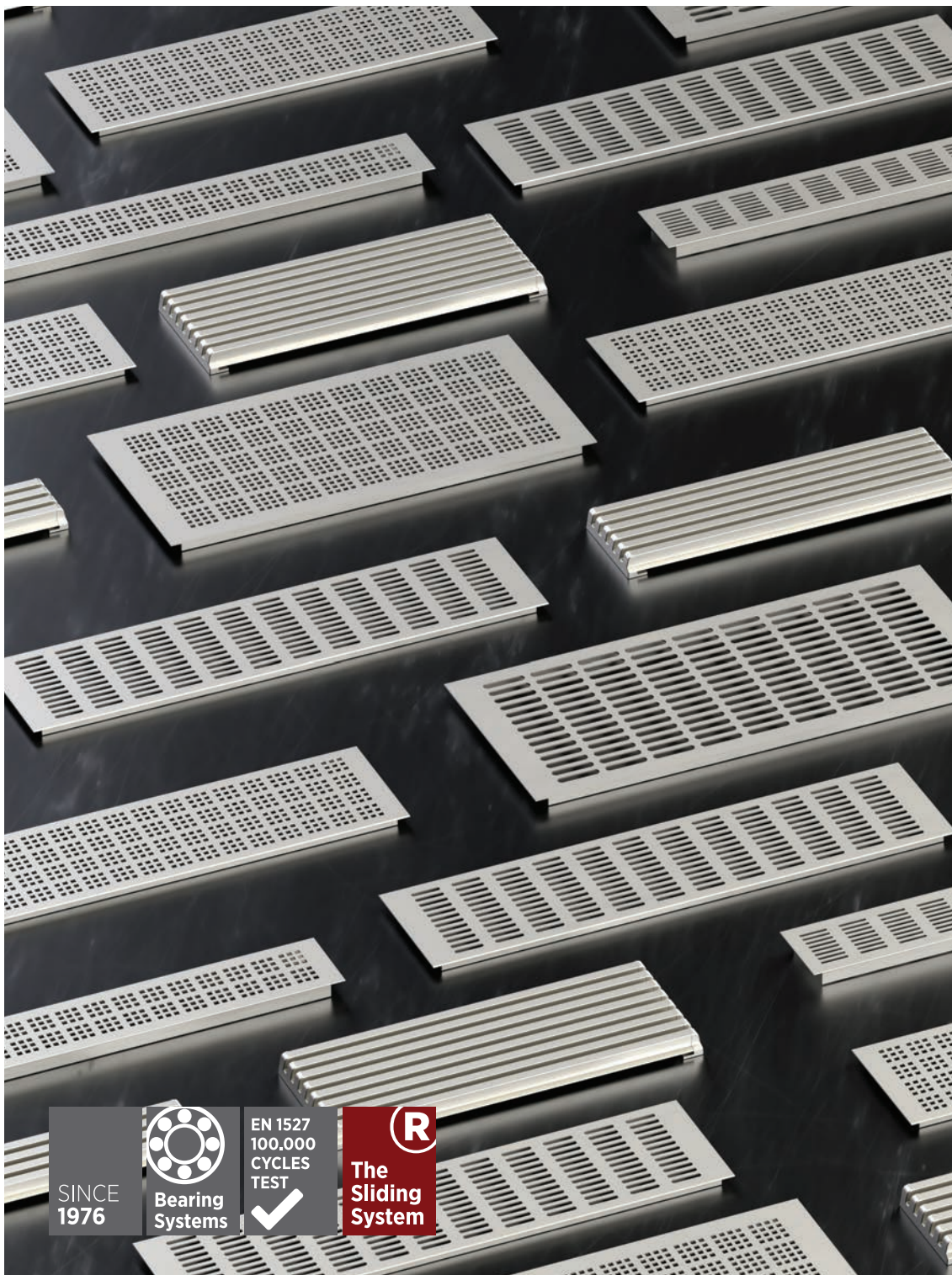

SINCE 1976

 **Bearing Systems**

EN 1527
100.000
CYCLES
TEST



R
The Sliding System



Ventil Aluminium

	OEM Kod OEM Code	Ürün Kodu Product Code	Genişlik Length	Standart Min. Ölçü Standard Min. Size	Standart Max. Ölçü Standard Max. Size	Gömme Montaj Internal Montage	Yüzeyden Montaj External Montage	Standart Renk Standard Colour
1	140-0440	Ventil 440	60 mm	423 mm	900 mm		✓	Mat Anodized / Parlak, Bright
2	140-0460	Ventil 460	90 mm	423 mm	900 mm		✓	Mat Anodized / Parlak, Bright
3	140-0480	Ventil 480	120 mm	423 mm	900 mm		✓	Mat Anodized / Parlak, Bright
4	140-0900	Ventil 900	70 mm	200 mm	610 mm	✓		Mat Anodized / Parlak, Bright
5	140-0700	Ventil 700	120 mm	200 mm	610 mm	✓		Mat Anodized / Parlak, Bright
6	140-0750	Ventil 750	200 mm	270 mm	2000 mm	✓		Mat Anodized
7	140-0950	Ventil 950	70 mm	200 mm	763 mm	✓		Mat Anodized
8	140-0800	Ventil 800	120 mm	200 mm	763 mm	✓		Mat Anodized
9	140-0850	Ventil 850	200 mm	270 mm	763 mm	✓		Mat Anodized

- Verilen ölçüler bağlayıcı değildir. Önerilen kurulum ölçüleridir. Albatır ürün özelliklerinde haber vermeden değişiklik yapabilir.
- The given dimension are not binding. These are recommended asamble dimensions. Albatır can make alteration to product specification without notice.

Ventil Aluminium

Group 140

ALÜMİNYUM DEKORATİF MENFEZ
ALUMINIUM AIR VENTILATION COVER



140-0440



140-0460



140-0480

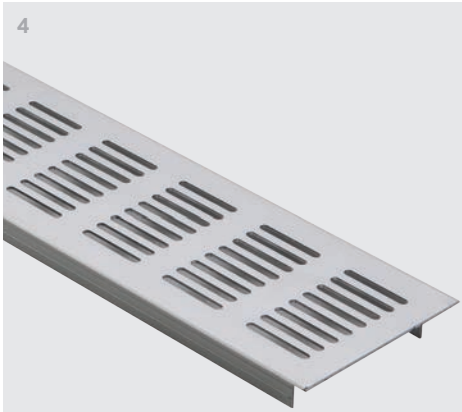

140-0900

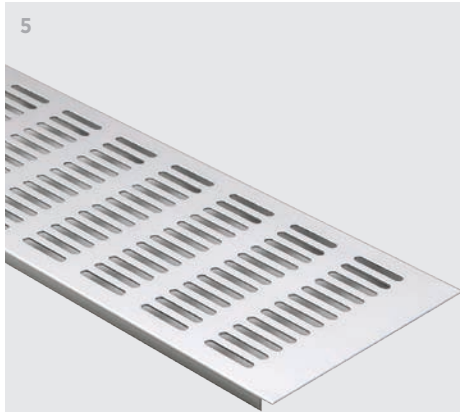

140-0700

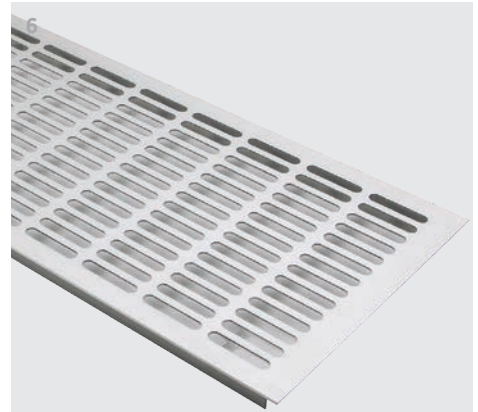

140-0750



140-0950

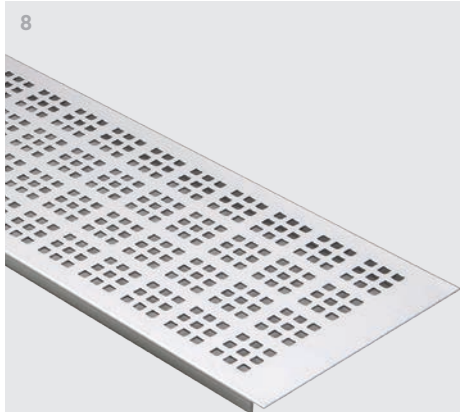

140-0800

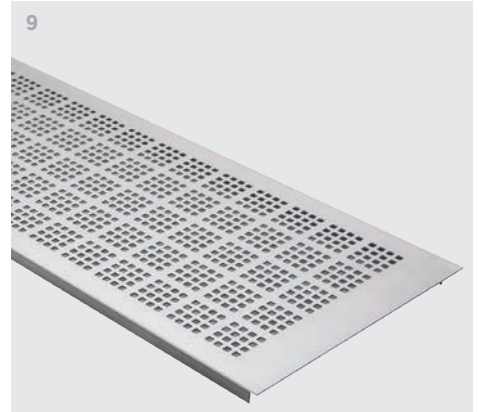

140-0850

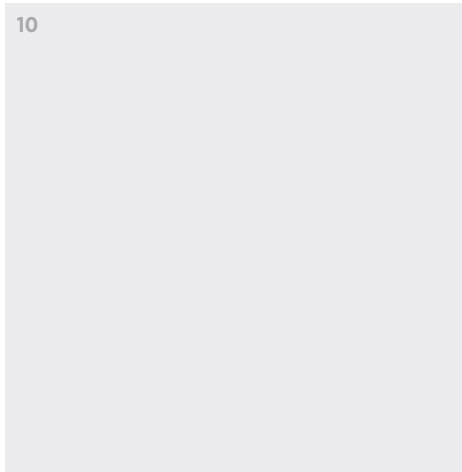

10

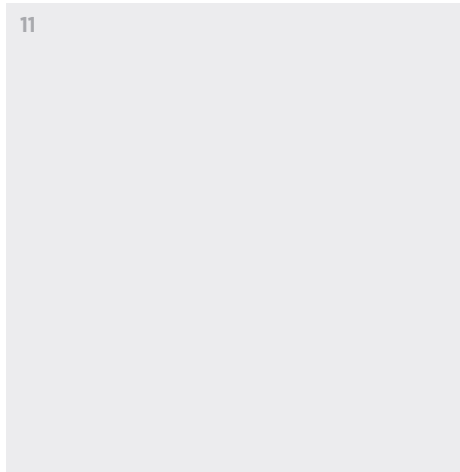

11

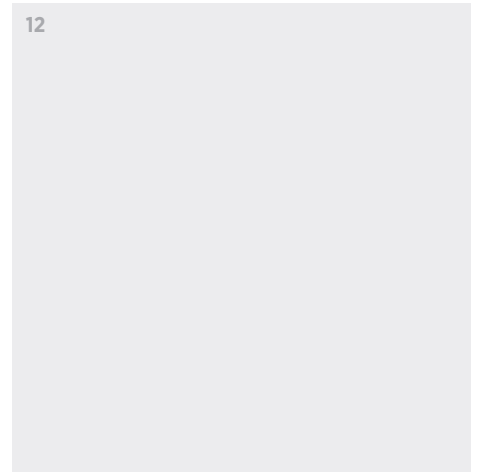

12

Ventil Aluminium

Group 140

ALÜMİNYUM DEKORATİF MENFEZ
ALUMINIUM AIR VENTILATION COVER

140-0440 • BAR MENFEZ • AIR VENTILATION COVER



Bilgi / Information

- Eni 60 mm
- Width 60 mm

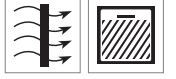

Kod / Code No	Boy / Size	Renk / Colour	Birim / Unit		
140-0440-1410-0423	423 mm	Eloksal / Mat Anodized	1 Adet / 1 Pcs	10	630
140-0440-1410-0610	610 mm	Eloksal / Mat Anodized	1 Adet / 1 Pcs	10	420
140-0440-1410-0900	900 mm	Eloksal / Mat Anodized	1 Adet / 1 Pcs	10	420
140-0440-1420-0423	423 mm	Parlak / Bright	1 Adet / 1 Pcs	10	630
140-0440-1420-0610	610 mm	Parlak / Bright	1 Adet / 1 Pcs	10	420
140-0440-1420-0900	900 mm	Parlak / Bright	1 Adet / 1 Pcs	10	420

140-0460 • BAR MENFEZ • AIR VENTILATION COVER



Bilgi / Information

- Eni 90 mm
- Width 90 mm

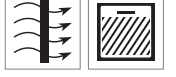

Kod / Code No	Boy / Size	Renk / Colour	Birim / Unit		
140-0460-1410-0423	423 mm	Eloksal / Mat Anodized	1 Adet / 1 Pcs	10	630
140-0460-1410-0610	610 mm	Eloksal / Mat Anodized	1 Adet / 1 Pcs	10	420
140-0460-1410-0900	900 mm	Eloksal / Mat Anodized	1 Adet / 1 Pcs	10	420
140-0460-1420-0423	423 mm	Parlak / Bright	1 Adet / 1 Pcs	10	630
140-0460-1420-0610	610 mm	Parlak / Bright	1 Adet / 1 Pcs	10	420
140-0460-1420-0900	900 mm	Parlak / Bright	1 Adet / 1 Pcs	10	420

140-0480 • BAR MENFEZ • AIR VENTILATION COVER



Bilgi / Information



- Eni 120 mm
- Width 120 mm



Kod / Code No	Boy / Size	Renk / Colour	Birim / Unit		
140-0480-1410-0423	423 mm	Eloksal / Mat Anodized	1 Adet / 1 Pcs	10	630
140-0480-1410-0610	610 mm	Eloksal / Mat Anodized	1 Adet / 1 Pcs	10	420
140-0480-1410-0900	900 mm	Eloksal / Mat Anodized	1 Adet / 1 Pcs	10	420
140-0480-1420-0423	423 mm	Parlak / Bright	1 Adet / 1 Pcs	10	630
140-0480-1420-0610	610 mm	Parlak / Bright	1 Adet / 1 Pcs	10	420
140-0480-1420-0900	900 mm	Parlak / Bright	1 Adet / 1 Pcs	10	420



Ventil Aluminium

<p>SINCE 1976</p>	 <p>Bearing Systems</p>	<p>EN 1527 100.000 CYCLES TEST</p> 	 <p>The Sliding System</p>
-----------------------	--	--	---



Ventil Aluminium

Group 140

ALÜMİNYUM DEKORATİF MENFEZ
ALUMINIUM AIR VENTILATION COVER

140-0900 • KOZA MENFEZ • AIR VENTILATION COVER

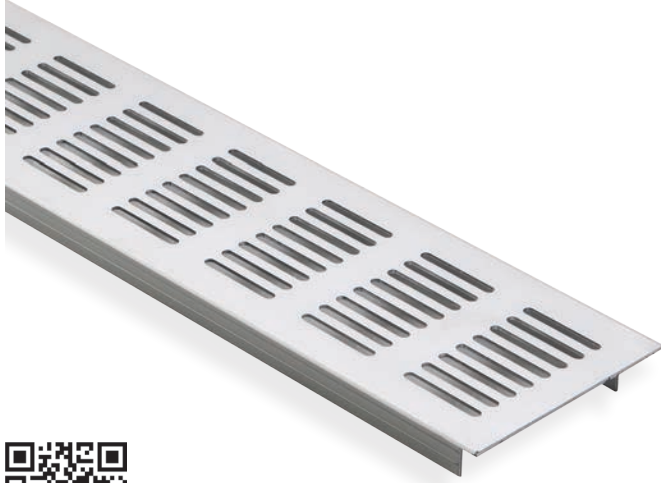

Bilgi / Information

- Eni 70 mm
- Birim adet fiyatlandır.
- Pakette 2 adet mevcuttur.

- Width 70 mm
- Unit prices.
- 2 Pcs in a bag.

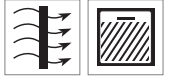

Kod / Code No	Boy / Size	Renk / Colour	Birim / Unit		
140-0900-1410-0200	200 mm	Eloksal / Mat Anodized	1 Adet / 1 Pcs	20	3.000
140-0900-1410-0270	270 mm	Eloksal / Mat Anodized	1 Adet / 1 Pcs	20	2.000
140-0900-1410-0423	423 mm	Eloksal / Mat Anodized	1 Adet / 1 Pcs	20	1.200
140-0900-1410-0500	500 mm	Eloksal / Mat Anodized	1 Adet / 1 Pcs	20	1.200
140-0900-1410-0610	610 mm	Eloksal / Mat Anodized	1 Adet / 1 Pcs	20	800
140-0900-1410-0763	763 mm	Eloksal / Mat Anodized	1 Adet / 1 Pcs	20	500
140-0900-1420-0270	270 mm	Parlak / Bright	1 Adet / 1 Pcs	20	2.000
140-0900-1420-0423	423 mm	Parlak / Bright	1 Adet / 1 Pcs	20	1.200
140-0900-1420-0500	500 mm	Parlak / Bright	1 Adet / 1 Pcs	20	1.200
140-0900-1420-0610	610 mm	Parlak / Bright	1 Adet / 1 Pcs	20	800

140-0700 • KOZA MENFEZ • AIR VENTILATION COVER

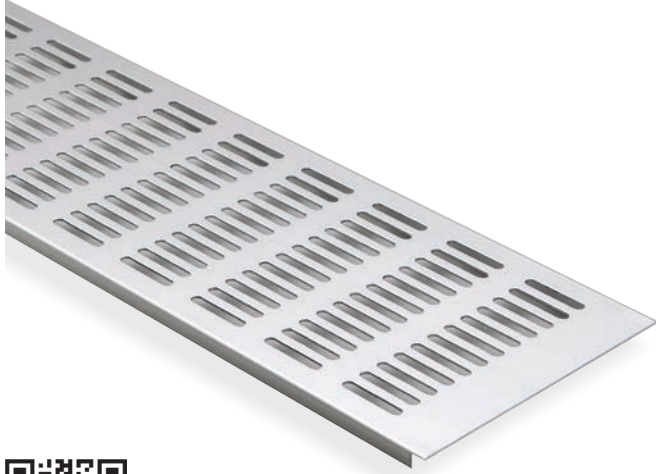

Bilgi / Information

- Eni 120 mm
- Birim adet fiyatlandır.
- Pakette 2 adet mevcuttur.

- Width 120 mm
- Unit prices.
- 2 Pcs in a bag.

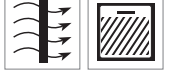

Kod / Code No	Boy / Size	Renk / Colour	Birim / Unit		
140-0700-1410-0200	200 mm	Eloksal / Mat Anodized	1 Adet / 1 Pcs	20	2.500
140-0700-1410-0270	270 mm	Eloksal / Mat Anodized	1 Adet / 1 Pcs	20	2.000
140-0700-1410-0423	423 mm	Eloksal / Mat Anodized	1 Adet / 1 Pcs	20	800
140-0700-1410-0500	500 mm	Eloksal / Mat Anodized	1 Adet / 1 Pcs	20	800
140-0700-1410-0610	610 mm	Eloksal / Mat Anodized	1 Adet / 1 Pcs	20	800
140-0700-1410-0763	763 mm	Eloksal / Mat Anodized	1 Adet / 1 Pcs	20	600
140-0700-1420-0270	270 mm	Parlak / Bright	1 Adet / 1 Pcs	20	2.000
140-0700-1420-0423	423 mm	Parlak / Bright	1 Adet / 1 Pcs	20	800
140-0700-1420-0500	500 mm	Parlak / Bright	1 Adet / 1 Pcs	20	800
140-0700-1420-0610	610 mm	Parlak / Bright	1 Adet / 1 Pcs	20	800

140-0750 • KOZA MENFEZ • AIR VENTILATION COVER

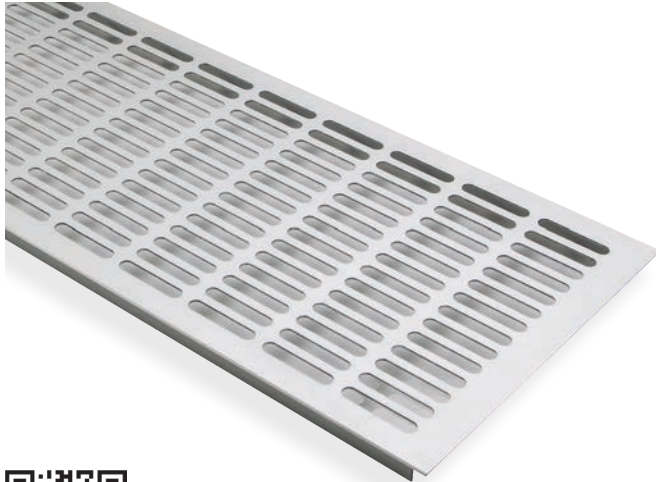

Bilgi / Information

- Eni 200 mm
- Birim adet fiyatlandır.
- Pakette 2 adet mevcuttur.

- Width 200 mm
- Unit prices.
- 2 Pcs in a bag.



Kod / Code No	Boy / Size	Renk / Colour	Birim / Unit		
140-0750-1410-0270	270 mm	Eloksal / Mat Anodized	1 Adet / 1 Pcs	10	800
140-0750-1410-0423	423 mm	Eloksal / Mat Anodized	1 Adet / 1 Pcs	10	600
140-0750-1410-0500	500 mm	Eloksal / Mat Anodized	1 Adet / 1 Pcs	10	600
140-0750-1410-0610	610 mm	Eloksal / Mat Anodized	1 Adet / 1 Pcs	10	400
140-0750-1410-0763	763 mm	Eloksal / Mat Anodized	1 Adet / 1 Pcs	10	250
140-0750-1410-1000	1000 mm	Eloksal / Mat Anodized	1 Adet / 1 Pcs	4	120
140-0750-1410-2000	2000 mm	Eloksal / Mat Anodized	1 Adet / 1 Pcs	4	120

Ventil Aluminium

Group 140

ALÜMİNYUM DEKORATİF MENFEZ
ALUMINIUM AIR VENTILATION COVER

140-0950 • KARE MENFEZ • AIR VENTILATION COVER



Bilgi / Information

- Eni 70 mm
- Birim adet fiyatlandır.
- Pakette 2 adet mevcuttur.

- Width 70 mm
- Unit prices.
- 2 Pcs in a bag.

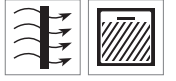

Kod / Code No	Boy / Size	Renk / Colour	Birim / Unit		
140-0950-1410-0200	200 mm	Eloksal / Mat Anodized	1 Adet / 1 Pcs	20	3.000
140-0950-1410-0270	270 mm	Eloksal / Mat Anodized	1 Adet / 1 Pcs	20	2.000
140-0950-1410-0423	423 mm	Eloksal / Mat Anodized	1 Adet / 1 Pcs	20	1.200
140-0950-1410-0500	500 mm	Eloksal / Mat Anodized	1 Adet / 1 Pcs	20	1.200
140-0950-1410-0610	610 mm	Eloksal / Mat Anodized	1 Adet / 1 Pcs	20	800
140-0950-1410-0763	763 mm	Eloksal / Mat Anodized	1 Adet / 1 Pcs	20	500

140-0800 • KARE MENFEZ • AIR VENTILATION COVER

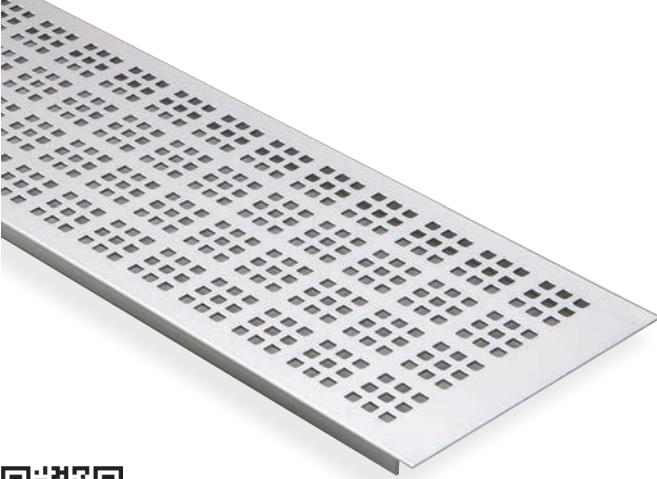

Bilgi / Information

- Eni 120 mm
- Birim adet fiyatlandır.
- Pakette 2 adet mevcuttur.

- Width 120 mm
- Unit prices.
- 2 Pcs in a bag.

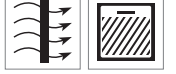

Kod / Code No	Boy / Size	Renk / Colour	Birim / Unit		
140-0800-1410-0200	200 mm	Eloksal / Mat Anodized	1 Adet / 1 Pcs	20	2.500
140-0800-1410-0270	270 mm	Eloksal / Mat Anodized	1 Adet / 1 Pcs	20	2.000
140-0800-1410-0423	423 mm	Eloksal / Mat Anodized	1 Adet / 1 Pcs	20	800
140-0800-1410-0500	500 mm	Eloksal / Mat Anodized	1 Adet / 1 Pcs	20	800
140-0800-1410-0610	610 mm	Eloksal / Mat Anodized	1 Adet / 1 Pcs	20	800
140-0800-1410-0763	763 mm	Eloksal / Mat Anodized	1 Adet / 1 Pcs	20	600

140-0850 • KARE MENFEZ • AIR VENTILATION COVER

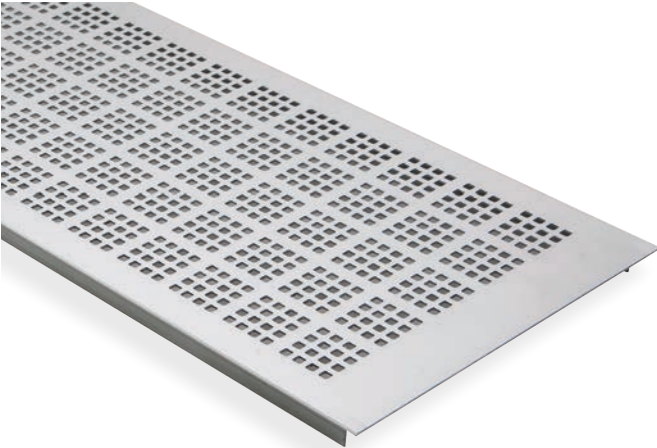

Bilgi / Information

- Eni 200 mm
- Birim adet fiyatlandır.
- Pakette 2 adet mevcuttur.

- Width 200 mm
- Unit prices.
- 2 Pcs in a bag.



Kod / Code No	Boy / Size	Renk / Colour	Birim / Unit		
140-0850-1410-0270	270 mm	Eloksal / Mat Anodized	1 Adet / 1 Pcs	10	800
140-0850-1410-0423	423 mm	Eloksal / Mat Anodized	1 Adet / 1 Pcs	10	600
140-0850-1410-0500	500 mm	Eloksal / Mat Anodized	1 Adet / 1 Pcs	10	600
140-0850-1410-0610	610 mm	Eloksal / Mat Anodized	1 Adet / 1 Pcs	10	400
140-0850-1410-0763	763 mm	Eloksal / Mat Anodized	1 Adet / 1 Pcs	10	250

Group 141

Ventil[®]Plastic

Plastik Dekoratif Menfez Serisi

Plastic Air Ventilation Cover Series



Bu serideki tüm ürünleri incelemek için
QR kodu okutabilirsiniz.

You can analyze the QR code to see all the
products in these series.



Ventil Plastic

<p>SINCE 1976</p>	 <p>Bearing Systems</p>	<p>EN 1527 100.000 CYCLES TEST</p> 	<p>R</p> <p>The Sliding System</p>
-----------------------	--	--	---



	OEM Kod OEM Code	Ürün Kodu Product Code	Ebat Size	Gömme Montaj Internal Montage	Yüzeyden Montaj External Montage	Standart Renk Standard Colour
1	141-0680	Ventil 0680	76 x 430 mm	✓		M. Gri / M. Grey - Beyaz / White K. Kahve / D. Brown - Gri / Grey - Akçaağaç / Oak
2	141-0650	Ventil 0650	70 x 466 mm	✓		M. Gri / M. Grey - Beyaz / White K. Kahve / D. Brown - Siyah / Black
3	141-0630	Ventil 0630	51 x 215 mm	✓		Krom / Chrome - Mat Krom / Mat Chrome
4	141-0640	Ventil 0640	35 x 164 mm	✓		Krom / Chrome - Mat Krom / Mat Chrome
5	141-0670	Ventil 0670	50 x 50 mm	✓		Krom / Chrome - Mat Krom / Mat Chrome
6	141-0600	Ventil 0600	200 x 30 mm	✓		M. Gri / M. Grey - Krem / Cream - Kahve / Brown K. Kahve / D. Brown - Krom / Chrome - Siyah / Black
7	141-0620	Ventil 0620	Ø 34 mm	✓		Beyaz / White - K. Kahve / D. Brown Gri / Grey - Krom / Chrome - Siyah / Black
8	141-0625	Ventil 0625	Ø 34 mm	✓		Beyaz / White - K. Kahve / D. Brown Gri / Grey - Krom / Chrome - Siyah / Black
9	141-0660	Ventil 0660	Ø 44 mm	✓		Beyaz / White - K. Kahve / D. Brown Gri / Grey - Krom / Chrome
10	141-0610	Ventil 0610	Ø 60 mm	✓		Beyaz / White - K. Kahve / D. Brown Gri / Grey - Krom / Chrome
11	141-0700	Ventil 0700	458 x 65 mm	✓		Beyaz / White - K. Kahve / D. Brown Gri / Grey - Krom / Chrome
12	141-0750	Ventil 0750	391 x 65 mm	✓		Beyaz / White - K. Kahve / D. Brown Gri / Grey - Krom / Chrome

• Verilen ölçüler bağlayıcı değildir. Önerilen kurulum ölçüleridir. Albatır ürün özelliklerinde haber vermeden değişiklik yapabilir.

• The given dimension are not binding. These are recommended asamble dimensions. Albatır can make alteration to product specification without notice.

Ventil Plastic

Group 141

PLASTİK DEKORATİF MENFEZ
PLASTIC AIR VENTILATION COVER

1



141-0680

2

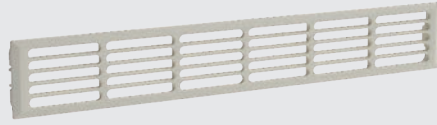

141-0650

3

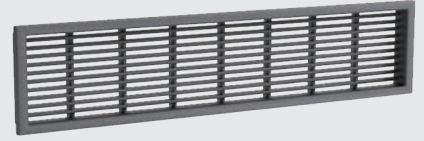

141-0630

4

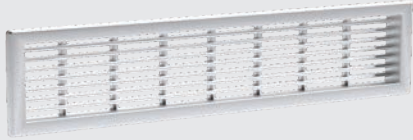

141-0640

5



141-0670

6

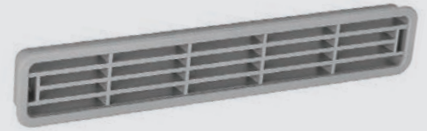

141-0600

7



141-0620

8



141-0625

9



141-0660

10



141-0610

11

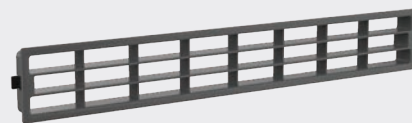

141-0700

12



141-0750

Ventil 0680

141-0680

PLASTİK 76 x 430 mm
PLASTIC 76 x 430 mm

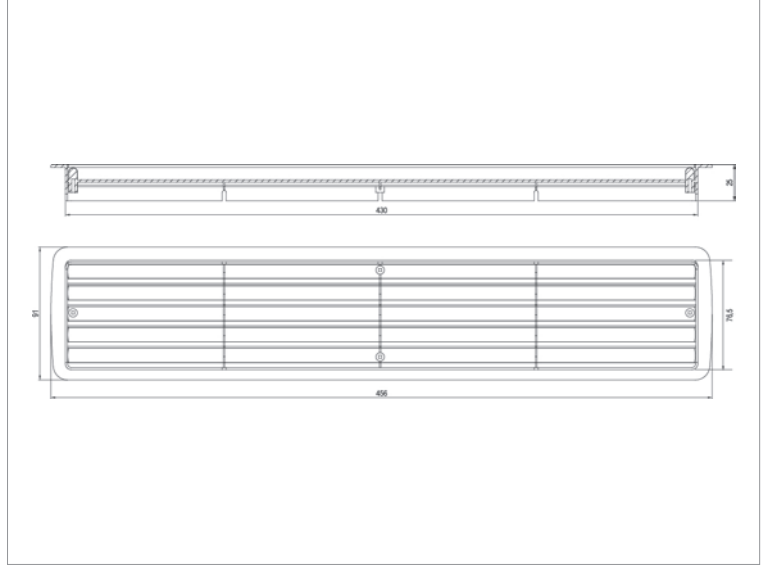

Kod / Code No	Renk / Colour	Br. / Unit		
141-0680-1700	M.Gri / M.Grey	1 Adet / 1 Pcs	10	280
141-0680-1650	Beyaz / White	1 Adet / 1 Pcs	10	280
141-0680-1670	K.Kahve / D.Brown	1 Adet / 1 Pcs	10	280
141-0680-1600	Gri / Grey	1 Adet / 1 Pcs	10	280
141-0680-1680	Akçaağaç / Oak	1 Adet / 1 Pcs	10	280

Bilgi / Information

- Birim adet fiyatlandırır.
- Pakette 2 adet mevcuttur.
- Unit prices are per piece.
- There are 2 pieces in the package.

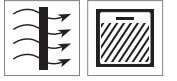

Ventil 0650

141-0650

PLASTİK 70 x 466 mm
PLASTIC 70 x 466 mm

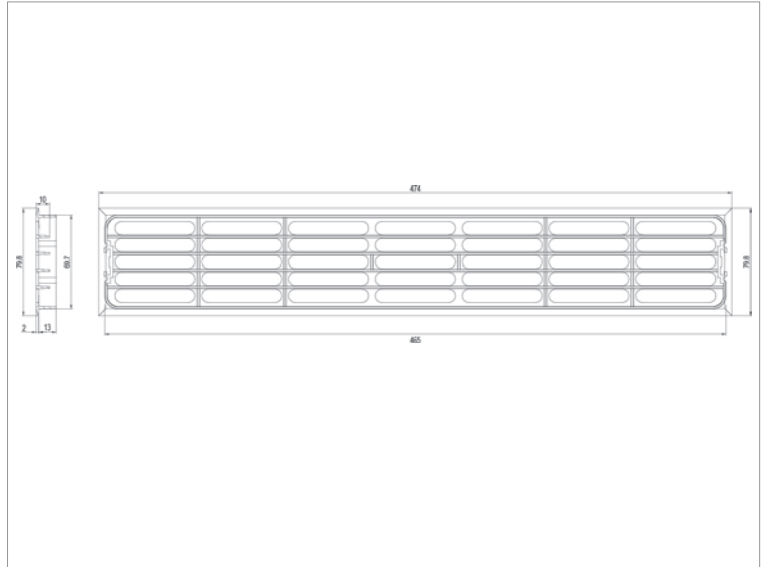
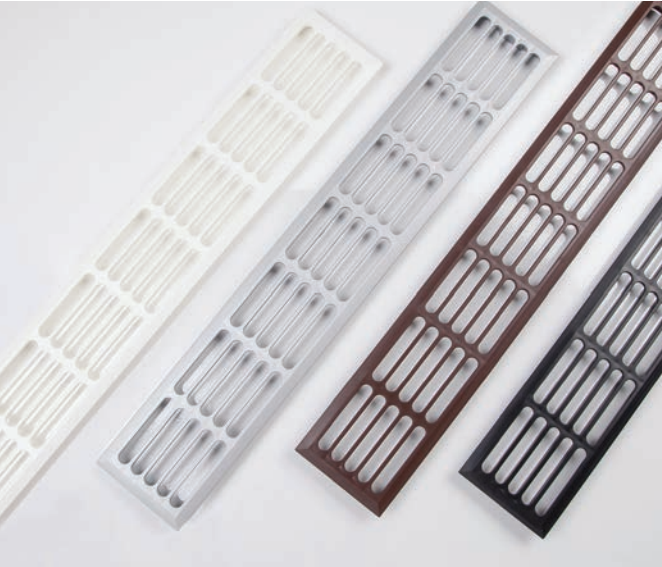

Kod / Code No	Renk / Colour	Br. / Unit		
141-0650-1700	M.Gri / M.Grey	1 Adet / 1 Pcs	14	400
141-0650-1650	Beyaz / White	1 Adet / 1 Pcs	14	400
141-0650-1670	K.Kahve / D.Brown	1 Adet / 1 Pcs	14	400
141-0650-1630	Siyah / Black	1 Adet / 1 Pcs	14	400

Bilgi / Information

- Birim adet fiyatlandırır.
- Pakette 2 adet mevcuttur.
- Unit prices are per piece.
- There are 2 pieces in the package.



Ventil 0630

141-0630

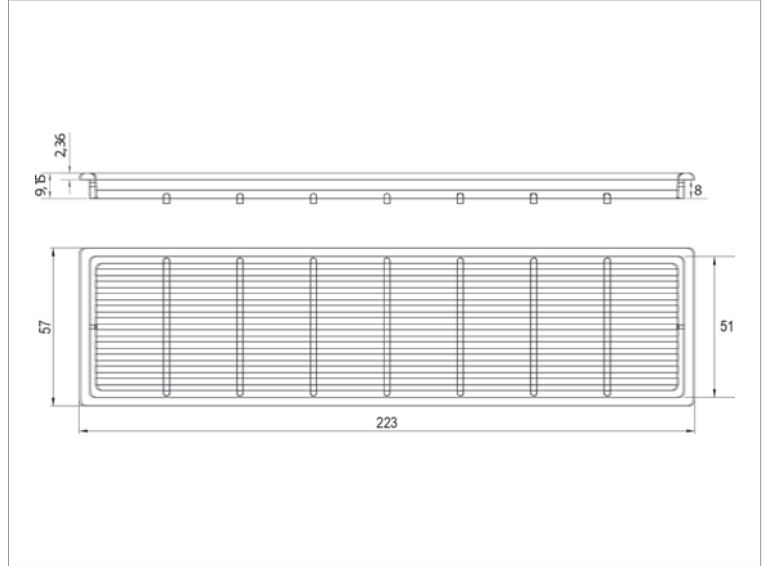
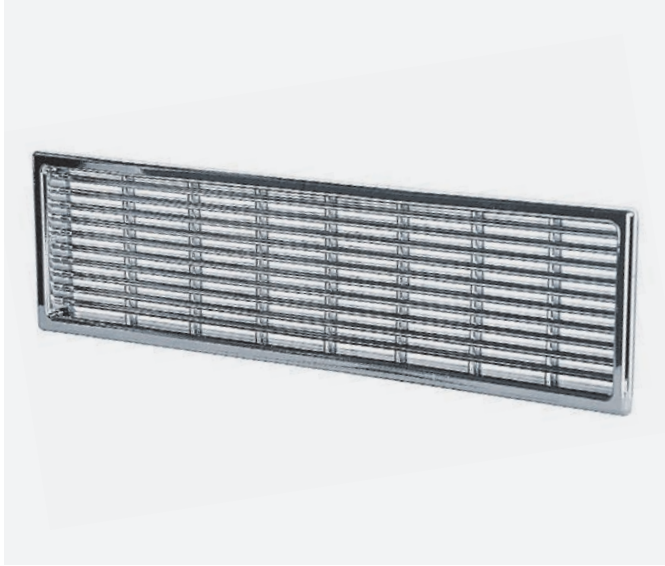

PLASTİK 51 x 215 mm

PLASTIC 51 x 215 mm



Bilgi / Information

- Birim adet fiyatlandırır.
- Unit prices are per piece.

Kod / Code No	Renk / Colour	Br. / Unit		
141-0630-1800	Krom / Chrome	1 Adet / 1 Pcs	50	2.000
141-0630-1810	Mat Krom / Mat Chrome	1 Adet / 1 Pcs	50	2.000



Ventil 0640

141-0640

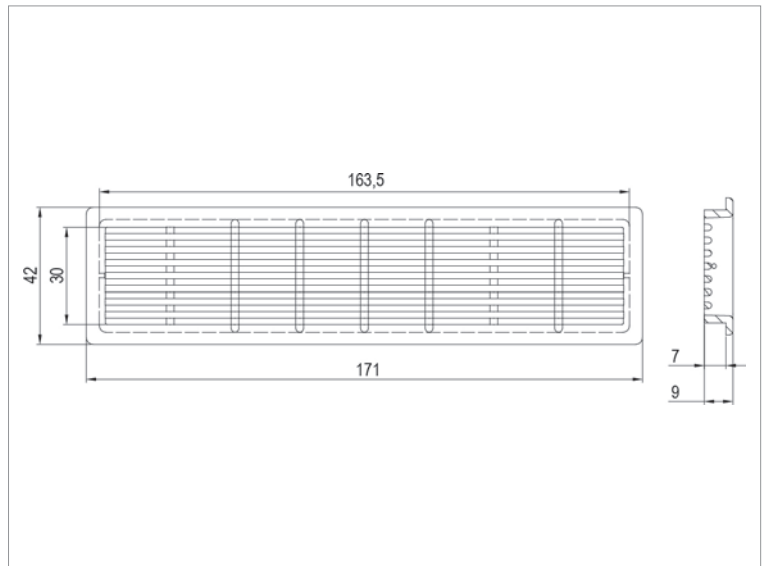
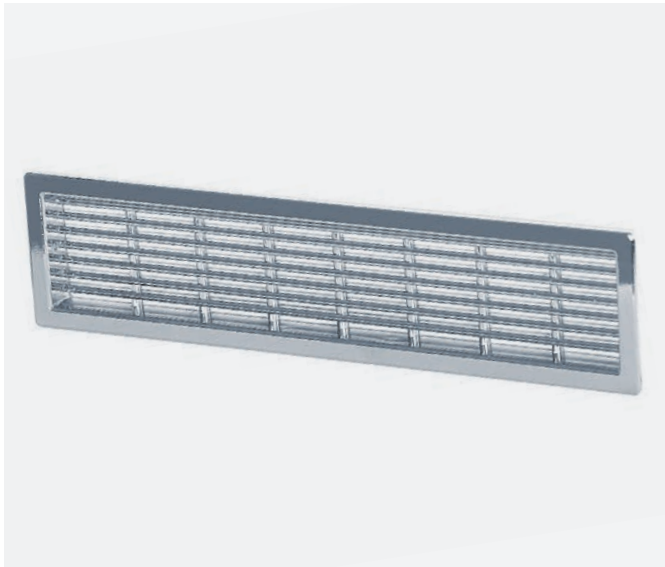

PLASTİK 35 x 164 mm

PLASTIC 35 x 164 mm



Bilgi / Information

- Birim adet fiyatlandırır.
- Unit prices are per piece.

Kod / Code No	Renk / Colour	Br. / Unit		
141-0640-1800	Krom / Chrome	1 Adet / 1 Pcs	50	2.000
141-0640-1810	Mat Krom / Mat Chrome	1 Adet / 1 Pcs	50	2.000



Ventil 0670

141-0670

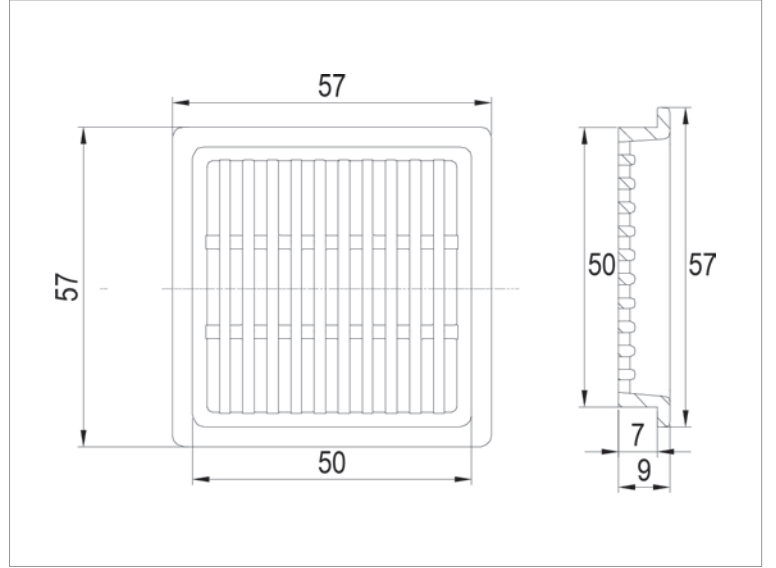

PLASTİK 50 x 50 mm

PLASTIC 50 x 50 mm



Bilgi / Information

- Birim adet fiyatlandırır.
- Unit prices are per piece.

Kod / Code No	Renk / Colour	Br. / Unit		
141-0670-1800	Krom / Chrome	1 Adet / 1 Pcs	50	2.500
141-0670-1810	Mat Krom / Mat Chrome	1 Adet / 1 Pcs	50	2.500

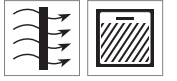

Ventil 0600

141-0600

PLASTİK 200 x 30 mm

PLASTIC 200 x 30 mm

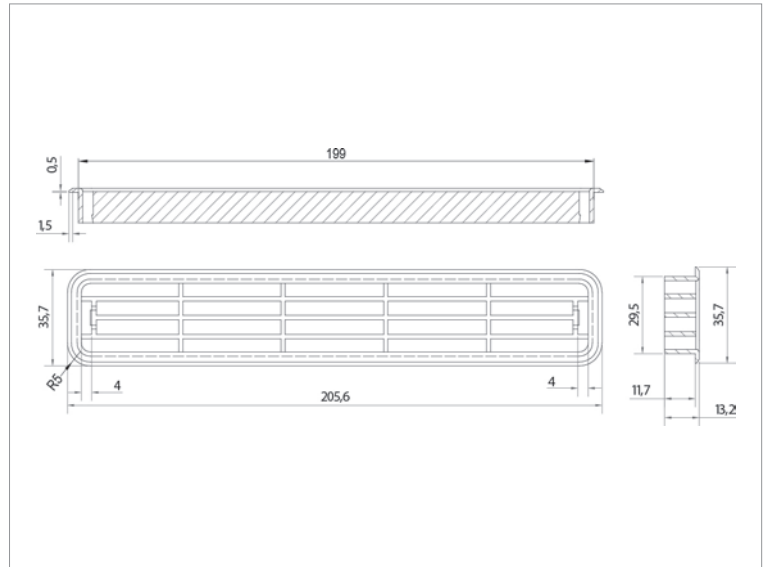
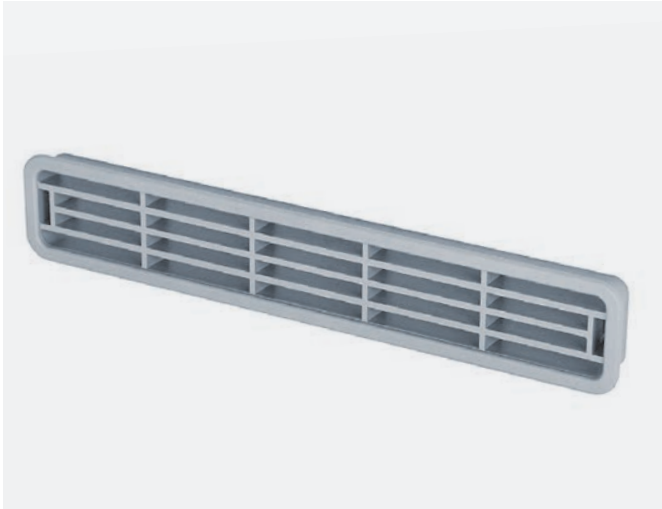

Bilgi / Information

- Birim adet fiyatlandırır.
- Unit prices are per piece.

Kod / Code No	Renk / Colour	Br. / Unit		
141-0600-1600	M.Gri / M.Grey	1 Adet / 1 Pcs	100	6.000
141-0600-1650	Beyaz / White	1 Adet / 1 Pcs	100	6.000
141-0600-1660	Krem / Cream	1 Adet / 1 Pcs	100	6.000
141-0600-1671	Kahve / Brown	1 Adet / 1 Pcs	100	6.000
141-0600-1670	K.Kahve / D.Brown	1 Adet / 1 Pcs	100	6.000
141-0600-1800	Krom / Chrome	1 Adet / 1 Pcs	50	6.000
141-0600-1630	Siyah / Black	1 Adet / 1 Pcs	100	6.000



Ventil 0620

141-0620

PLASTİK Ø 34 mm

PLASTIC Ø 34 mm

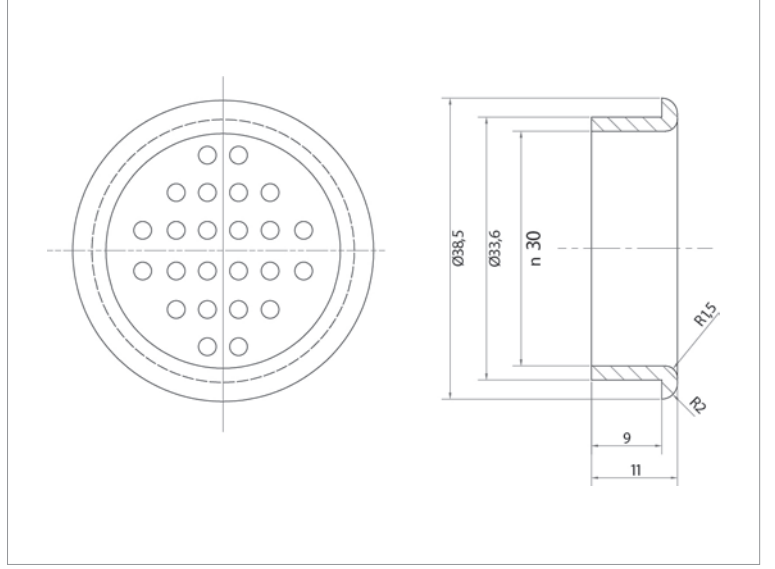

Kod / Code No	Renk / Colour	Br. / Unit		
141-0620-1650	Beyaz / White	1 Adet / 1 Pcs	100	5.000
141-0620-1670	K.Kahve / D.Brown	1 Adet / 1 Pcs	100	5.000
141-0620-1600	Gri / Grey	1 Adet / 1 Pcs	100	5.000
141-0620-1800	Krom / Chrome	1 Adet / 1 Pcs	100	5.000
141-0620-1630	Siyah / Black	1 Adet / 1 Pcs	100	5.000

Bilgi / Information

- Birim adet fiyatlandırır.
- Unit prices are per piece.



Ventil 0625

141-0625

PLASTİK Ø 34 mm

PLASTIC Ø 34 mm

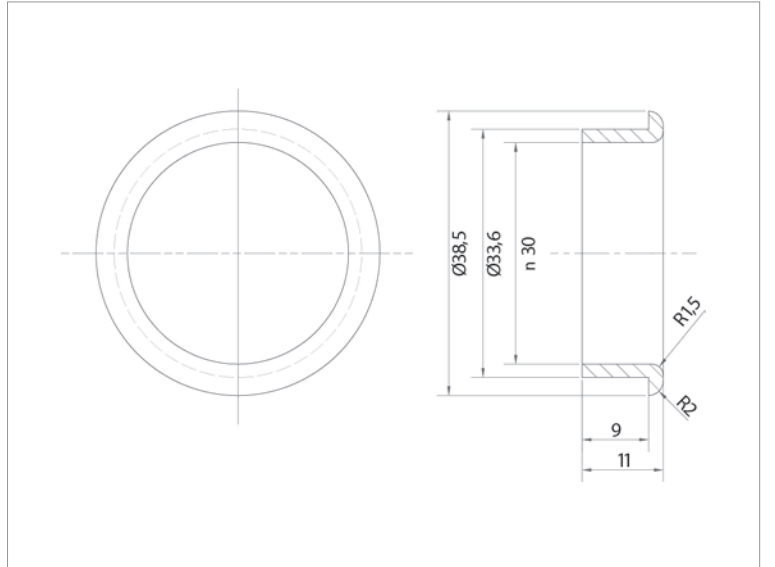

Kod / Code No	Renk / Colour	Br. / Unit		
141-0625-1650	Beyaz / White	1 Adet / 1 Pcs	100	5.000
141-0625-1670	K.Kahve / D.Brown	1 Adet / 1 Pcs	100	5.000
141-0625-1600	Gri / Grey	1 Adet / 1 Pcs	100	5.000
141-0625-1800	Krom / Chrome	1 Adet / 1 Pcs	100	5.000
141-0625-1630	Siyah / Black	1 Adet / 1 Pcs	100	5.000

Bilgi / Information

- Birim adet fiyatlandırır.
- Unit prices are per piece.



Ventil 0660

141-0660

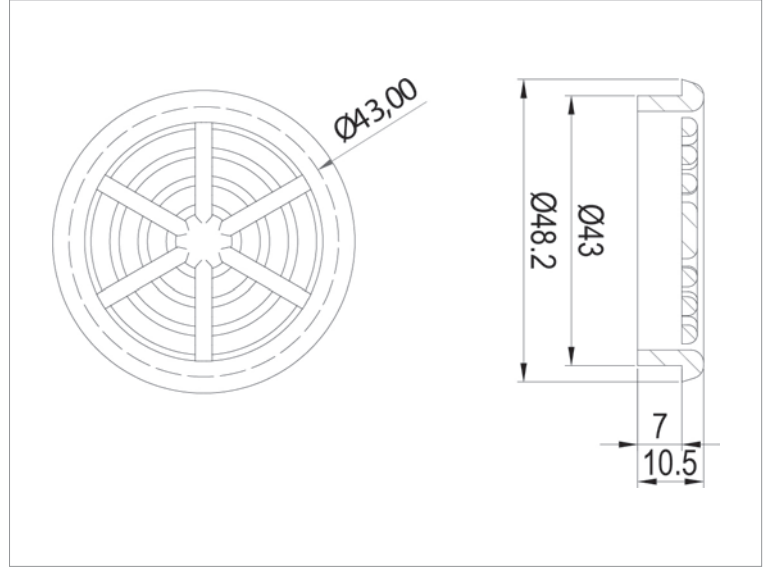

PLASTİK Ø 44 mm

PLASTIC Ø 44 mm



Bilgi / Information

- Birim adet fiyatlandırır.
- Unit prices are per piece.

Kod / Code No	Renk / Colour	Br. / Unit		
141-0660-1650	Beyaz / White	1 Adet / 1 Pcs	100	5.000
141-0660-1670	K.Kahve / D.Brown	1 Adet / 1 Pcs	100	5.000
141-0660-1600	Gri / Grey	1 Adet / 1 Pcs	100	5.000
141-0660-1800	Krom / Chrome	1 Adet / 1 Pcs	100	5.000

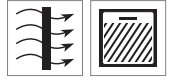

Ventil 0610

141-0610

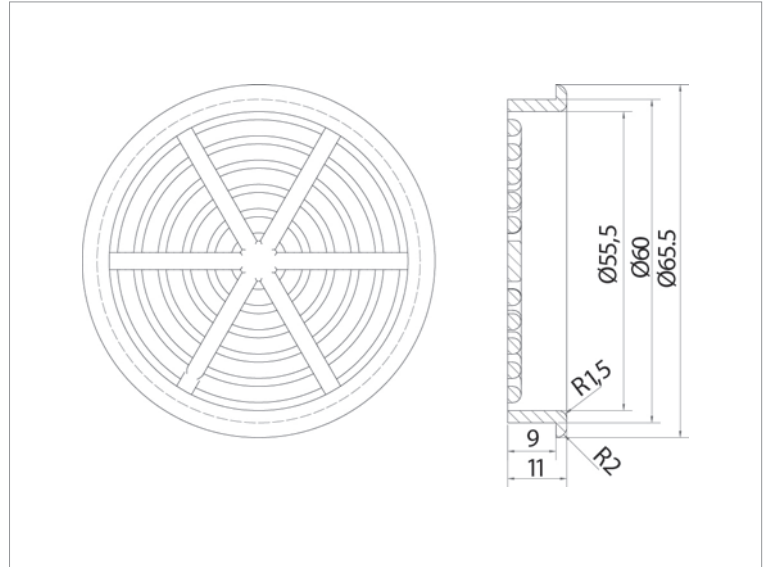

PLASTİK Ø 60 mm

PLASTIC Ø 60 mm



Bilgi / Information

- Birim adet fiyatlandırır.
- Unit prices are per piece.

Kod / Code No	Renk / Colour	Br. / Unit		
141-0610-1650	Beyaz / White	1 Adet / 1 Pcs	100	4.000
141-0610-1670	K.Kahve / D.Brown	1 Adet / 1 Pcs	100	4.000
141-0610-1600	Gri / Grey	1 Adet / 1 Pcs	100	4.000
141-0610-1800	Krom / Chrome	1 Adet / 1 Pcs	100	4.000

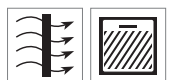

Ventil 0700

141-0700

PLASTİK 447 x 55 mm
PLASTIC 447 x 55 mm

Yeni Ürün
New Product

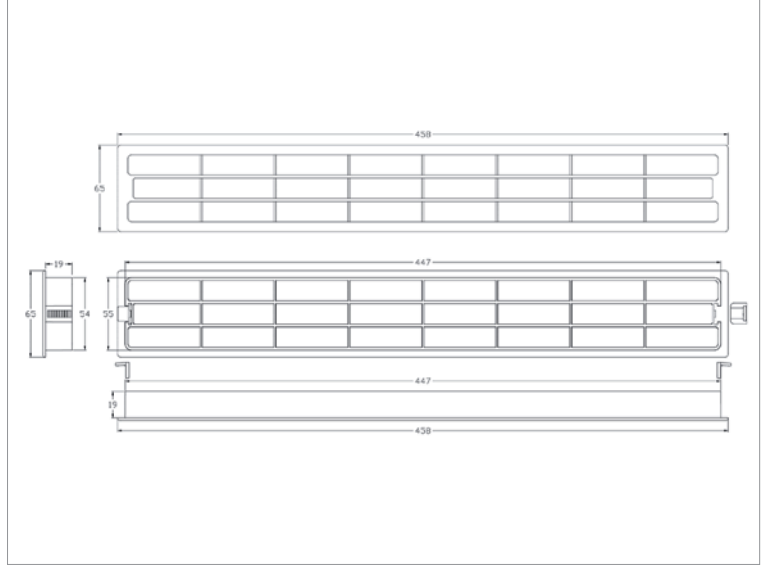
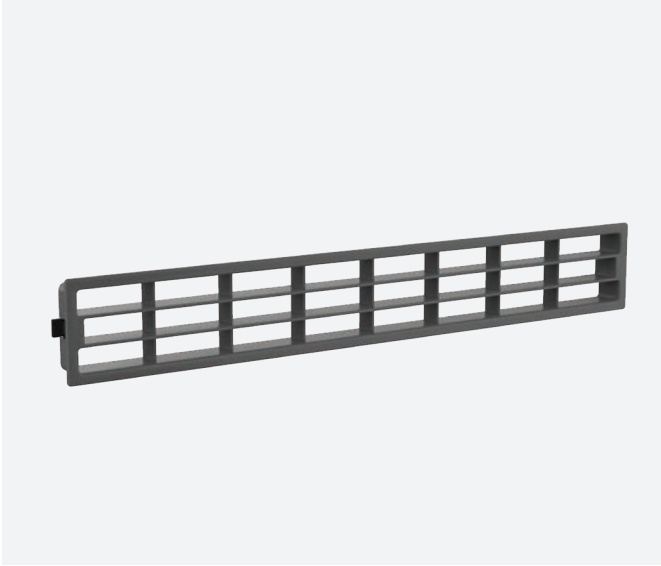

Kod / Code No	Renk / Colour	Br. / Unit		
141-0620-1650	Beyaz / White	1 Adet / 1 Pcs	100	5.000
141-0620-1670	K.Kahve / D.Brown	1 Adet / 1 Pcs	100	5.000
141-0620-1600	Gri / Grey	1 Adet / 1 Pcs	100	5.000
141-0620-1800	Krom / Chrome	1 Adet / 1 Pcs	100	5.000
141-0620-1630	Siyah / Black	1 Adet / 1 Pcs	100	5.000

Bilgi / Information

- Birim adet fiyatlandırır.
- Unit prices are per piece.

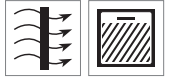

Ventil 0750

141-0750

PLASTİK 378 x 58,5 mm
PLASTIC 378 x 58,5 mm

Yeni Ürün
New Product

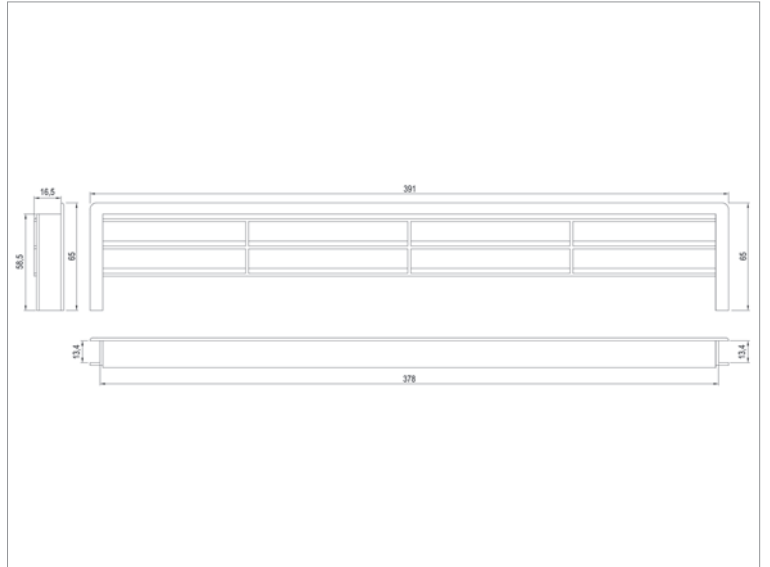

Kod / Code No	Renk / Colour	Br. / Unit		
141-0625-1650	Beyaz / White	1 Adet / 1 Pcs	100	5.000
141-0625-1670	K.Kahve / D.Brown	1 Adet / 1 Pcs	100	5.000
141-0625-1600	Gri / Grey	1 Adet / 1 Pcs	100	5.000
141-0625-1800	Krom / Chrome	1 Adet / 1 Pcs	100	5.000
141-0625-1630	Siyah / Black	1 Adet / 1 Pcs	100	5.000

Bilgi / Information

- Birim adet fiyatlandırır.
- Unit prices are per piece.

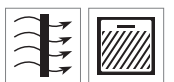

Group 142

TurnTable[®]

Döner Tabla Mekanizma Serisi
Swivel Plate - Turnable Table Series



Bu serideki tüm ürünleri incelemek için
QR kodu okutabilirsiniz.

You can analyze the QR code to see all the
products in these series.



TurnTable Series



SINCE
1976



Bearing
Systems

EN 1527
100.000
CYCLES
TEST



The
Sliding
System

	OEM Kod OEM Code	Ürün Kodu Product Code	Ebat Size	Genişlik Width	Standart Renk Standard Colour	Dönüş Açısı Turn Degree	Taşıma Capacity kg
1	142-0060	TurnTable 60	173 x 173 mm	12 mm	Galvaniz / Galvanized	360	80
2	142-0061	TurnTable 61	155 x 155 mm	12 mm	Siyah / Black	360	60
3	142-0062	TurnTable 62	176 x 176 mm	24 mm	Siyah / Black	360	80
4	142-0065	TurnTable 65	260 x 260 mm	12 mm	Galvaniz / Galvanized	360	100
5	142-0067	TurnTable 67	260 x 260 mm	27 mm	Galvaniz / Galvanized	360	120
6	142-0068	TurnTable 68	252 x 252 mm	27 mm	Siyah / Black	360	160
7	142-0070	TurnTable 70	200 x 200 mm	23 mm	Siyah / Black	110	120
8	142-0075	TurnTable 75	160 x 160 mm	20 mm	Siyah / Black	360	100
9	142-0081	TurnTable 81	176 x 176 mm	21 mm	Galvaniz / Galvanized	90	80

- Verilen ölçüler bağlayıcı değildir. Önerilen kurulum ölçüleridir. Albatır ürün özelliklerinde haber vermeden değişiklik yapabilir.
- The given dimension are not binding. These are recommended asamble dimensions. Albatır can make alteration to product specification without notice.

TurnTable

Group 142

DÖNER TABLA MEKANİZMASI
SWIVEL PLATE - TURNABLE TABLE MECHANISM

1



142-0060

2



142-0061

3



142-0062

4



142-0065

5



142-0067

6



142-0068

7



142-0070

8



142-0075

9

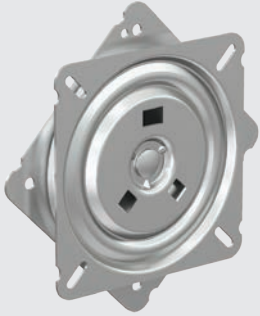

142-0081

10

11

12

TurnTable 60

142-0060

DÖNER TABLA MEKANİZMASI
SWIVEL PLATE - TURNABLE TABLE MECHANISM



Teknik Detay / Technical Detail

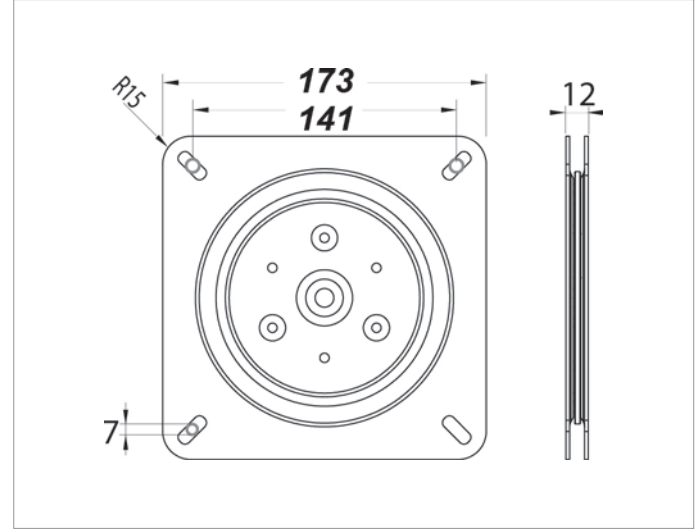

Ölçülerde değişiklik yapma hakkı saklıdır. Reserves the right to the change of the dimensions.



Kod / Code No	Açıklama / Description	L/W mm	Renk / Colour	Birim / Unit		
142-0060-1300	Döner Tabla Mekanizması / Swivel Plate - Turnable Table Mechanism	173 x 173 mm H:12 mm	Galvaniz / Galvanized	1 Adet / 1 Pcs	10	1.280

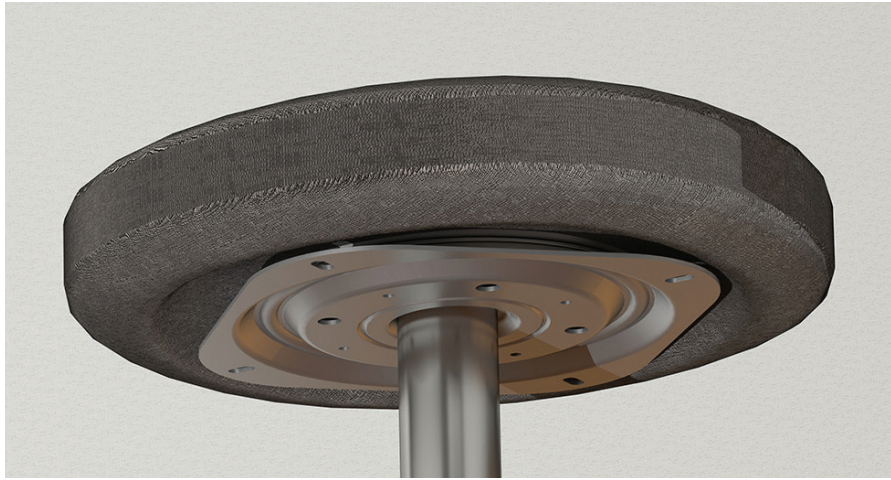

Ölçülerde değişiklik yapma hakkı saklıdır. Reserves the right to the change of the dimensions.

TurnTable 61

142-0061

DÖNER TABLA MEKANİZMASI
SWIVEL PLATE - TURNABLE TABLE MECHANISM



Teknik Detay / Technical Detail

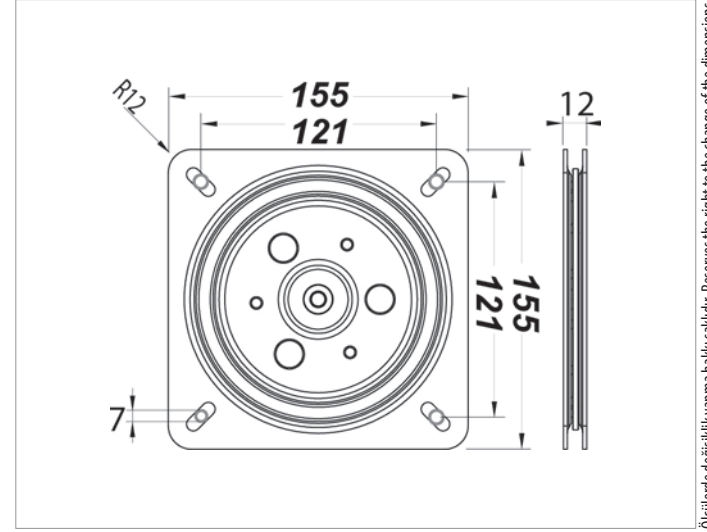

Ölçülerde değişiklik yapma hakkı saklıdır. Reserves the right to the change of the dimensions.

Kod / Code No	Açıklama / Description	L/W mm	Renk / Colour	Birim / Unit		
142-0061-1220	Döner Tabla Mekanizması / Swivel Plate - Turnable Table Mechanism	155 x 155 mm H:12 mm	Siyah / Black	1 Adet / 1 Pcs	10	1.280

TurnTable 62

142-0062

DÖNER TABLA MEKANİZMASI
SWIVEL PLATE - TURNABLE TABLE MECHANISM



Teknik Detay / Technical Detail

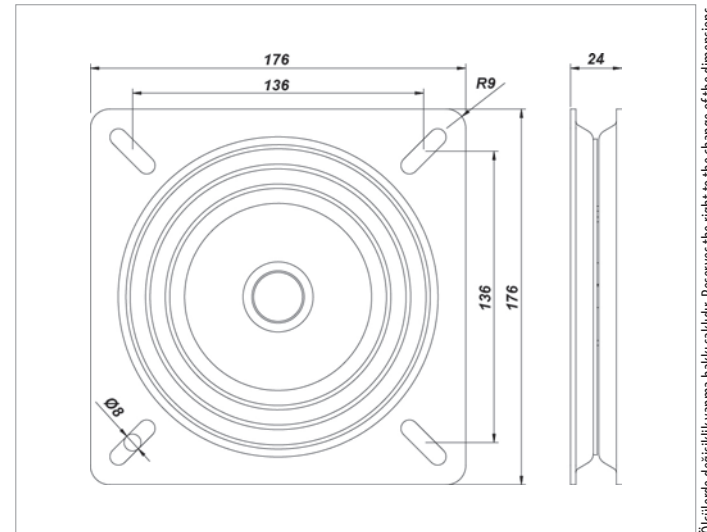

Ölçülerde değişiklik yapma hakkı saklıdır. Reserves the right to the change of the dimensions.

Bilgi / Information

- Ürününüz ölçüsel olarak güncellenmiştir.
- Product has been updated in terms of dimensions

Kod / Code No	Açıklama / Description	L/W mm	Renk / Colour	Birim / Unit		
142-0062-1220	Döner Tabla Mekanizması / Swivel Plate - Turnable Table Mechanism	176 x 176 mm H:24 mm	Siyah / Black	1 Adet / 1 Pcs	5	640

TurnTable 65

142-0065

DÖNER TABLA MEKANİZMASI
SWIVEL PLATE - TURNABLE TABLE MECHANISM



Teknik Detay / Technical Detail

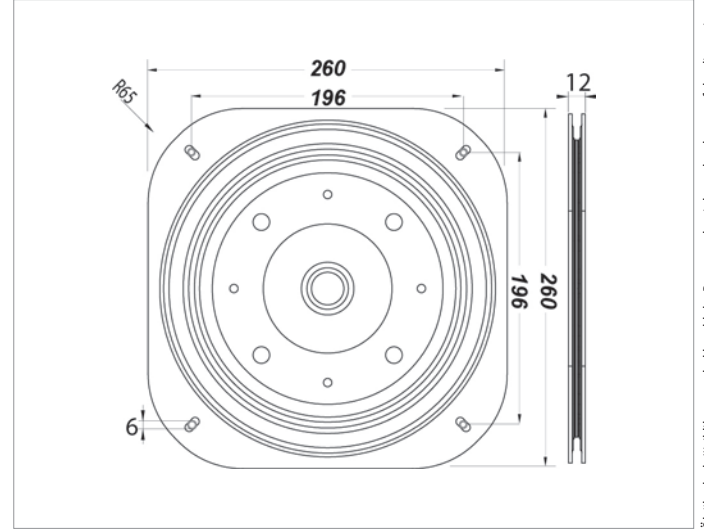

Kod / Code No	Açıklama / Description	L/W mm	Renk / Colour	Birim / Unit		
142-0065-1300	Döner Tabla Mekanizması / Swivel Plate - Turnable Table Mechanism	260 x 260 mm H:12 mm	Galvaniz / Galvanized	1 Adet / 1 Pcs	10	800

TurnTable 67

142-0067

DÖNER TABLA MEKANİZMASI
SWIVEL PLATE - TURNABLE TABLE MECHANISM



Teknik Detay / Technical Detail

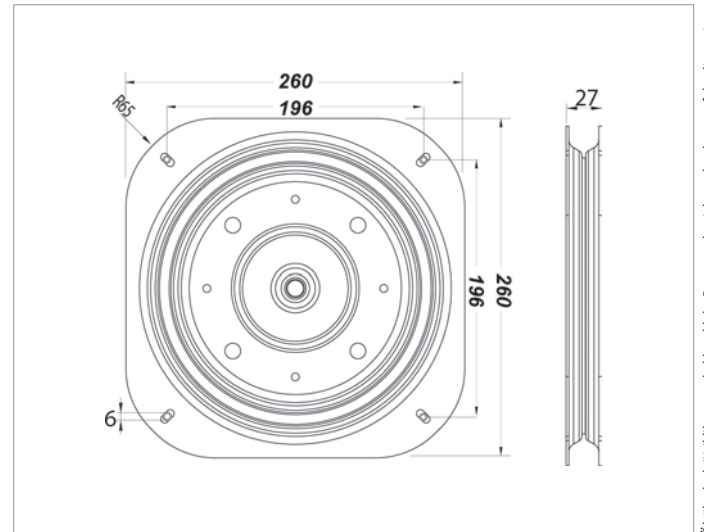

Kod / Code No	Açıklama / Description	L/W mm	Renk / Colour	Birim / Unit		
142-0067-1300	Döner Tabla Mekanizması / Swivel Plate - Turnable Table Mechanism	260 x 260 mm H:27 mm	Galvaniz / Galvanized	1 Adet / 1 Pcs	5	400

TurnTable 68

142-0068

DÖNER TABLA MEKANİZMASI
SWIVEL PLATE - TURNABLE TABLE MECHANISM



Teknik Detay / Technical Detail

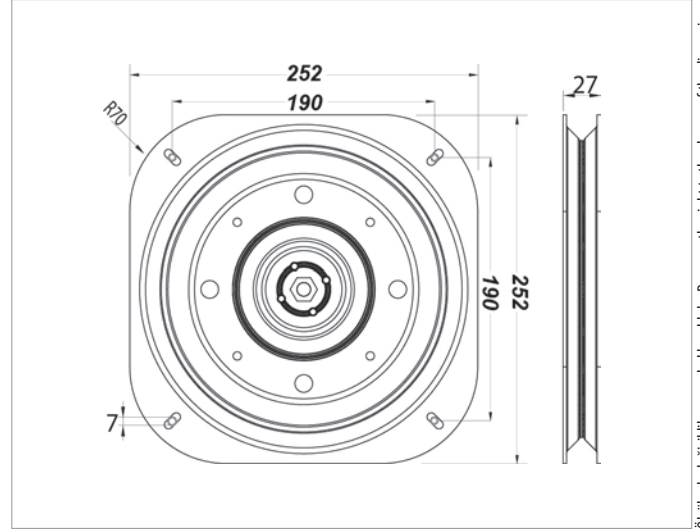

Ölçülerde değişiklik yapma hakkı saklıdır. Reserves the right to the change of the dimensions.

Kod / Code No	Açıklama / Description	L/W mm	Renk / Colour	Birim / Unit		
142-0068-1220	Döner Tabla Mekanizması / Swivel Plate - Turnable Table Mechanism	252 x 252 mm H:27 mm	Siyah / Black	1 Adet / 1 Pcs	5	240

TurnTable 70

142-0070

KONUM SABİTLEYİCİ
SWIVEL LOCATION STABILIZER



Teknik Detay / Technical Detail

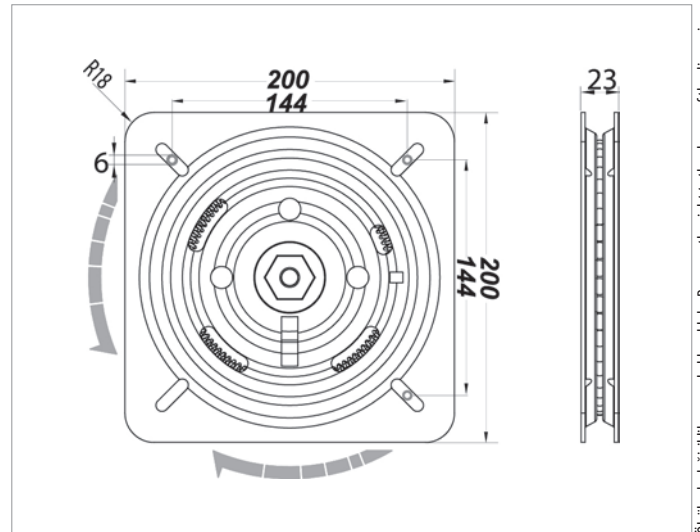

Ölçülerde değişiklik yapma hakkı saklıdır. Reserves the right to the change of the dimensions.

Kod / Code No	Açıklama / Description	L/W mm	Renk / Colour	Birim / Unit		
142-0070-1220	Konum Sabitleyici / Swivel Location Stabilizer	200 x 200 mm H:23 mm	Siyah / Black	1 Adet / 1 Pcs	6	288

TurnTable 75

142-0075

DÖNER TABLA MEKANİZMASI
SWIVEL PLATE - TURNABLE TABLE MECHANISM



Teknik Detay / Technical Detail

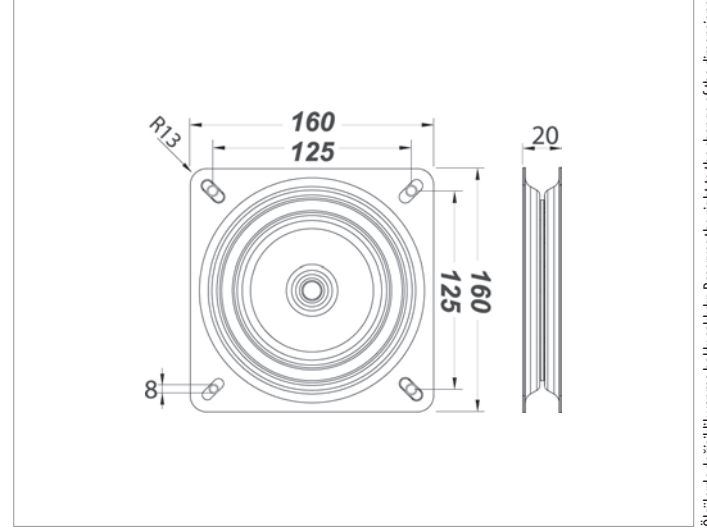

Ölçülerde değişiklik yapma hakkı saklıdır. Reserves the right to the change of the dimensions.



Kod / Code No	Açıklama / Description	L/W mm	Renk / Colour	Birim / Unit		
142-0075-1220	Döner Tabla Mekanizması / Swivel Plate - Turnable Table Mechanism	160 x 160 mm H:20 mm	Siyah / Black	1 Adet / 1 Pcs	5	480

TurnTable 81

142-0081

KONUM SABİTLEYİCİ
SWIVEL LOCATION STABILIZER

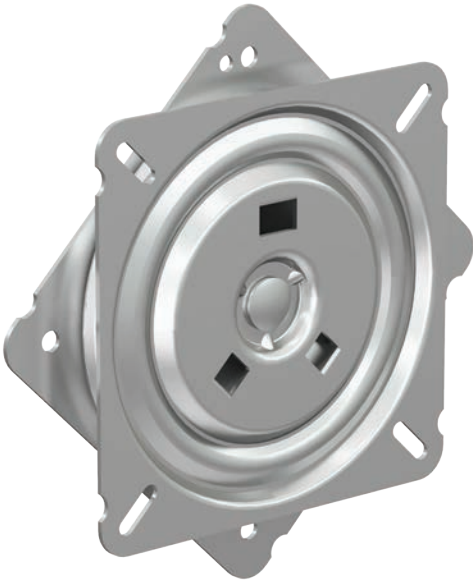

Teknik Detay / Technical Detail

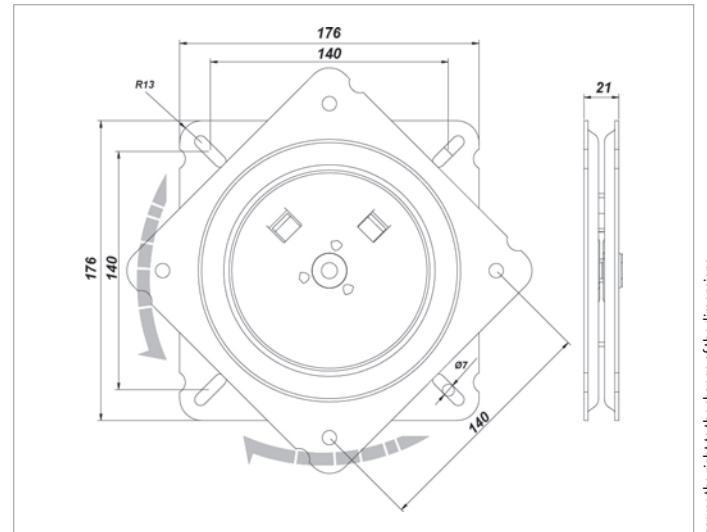

Ölçülerde değişiklik yapma hakkı saklıdır. Reserves the right to the change of the dimensions.



Kod / Code No	Açıklama / Description	L/W mm	Renk / Colour	Birim / Unit		
142-0081-1300	Konum Sabitleyici / Swivel Location Stabilizer	176 x 176 mm H:21 mm	Galvaniz / Galvanized	1 Adet / 1 Pcs	5	640



TurnTable Series

SINCE 1976

 Bearing Systems

EN 1527
100.000
CYCLES
TEST

 The Sliding System 



Group 143

Master+

Mobilya Aksesuarları
Furniture Accessories

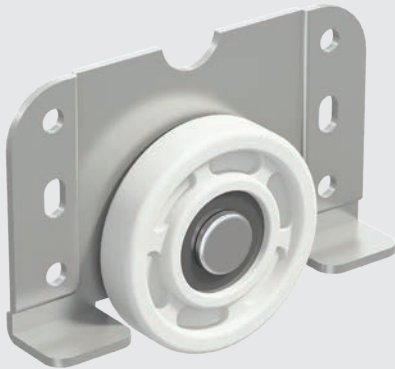
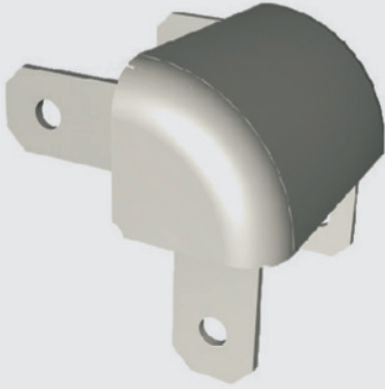

Bu serideki tüm ürünleri incelemek için
QR kodu okutabilirsiniz.

You can analyze the QR code to see all the
products in these series.

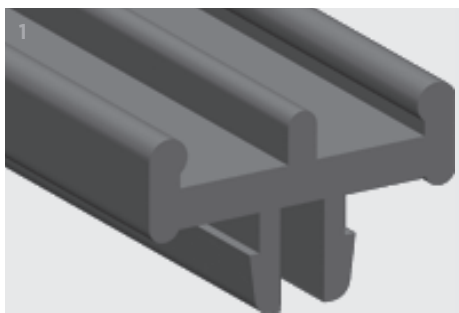

151-0001

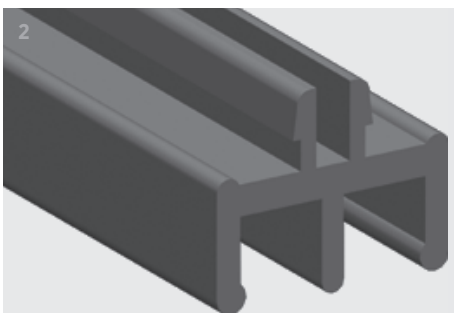

151-0002

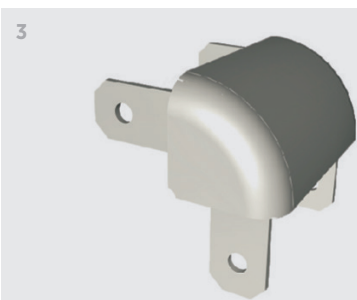

143-1328-001

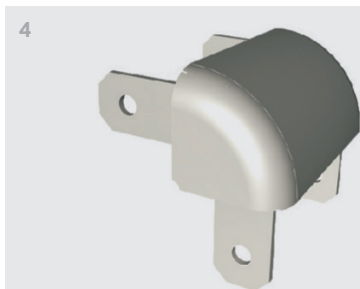

143-1328-002

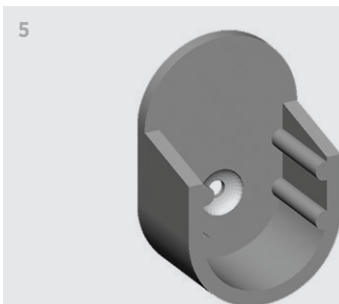

143-2413

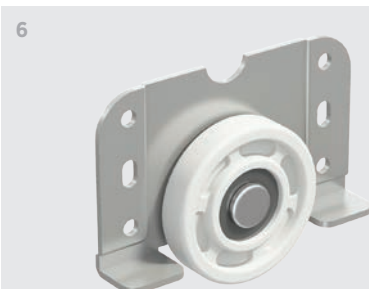

143-7056

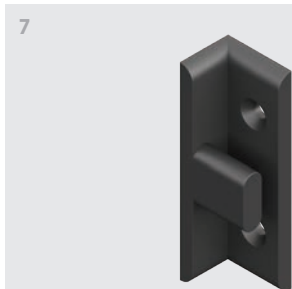

143-1000



143-1010



143-1020



143-1030



143-1040



143-1050

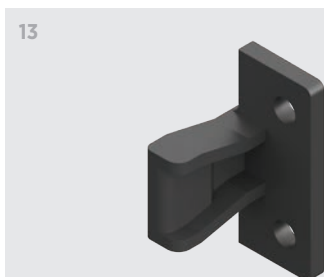

143-1060

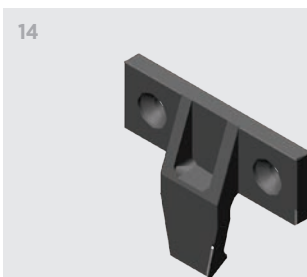

143-1070

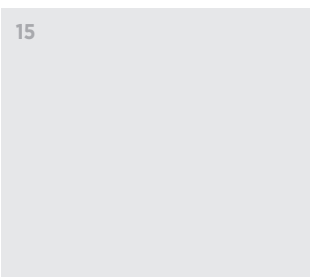

15

151-0001

ALT PVC PROFİL • BOTTOM PVC PROFILE

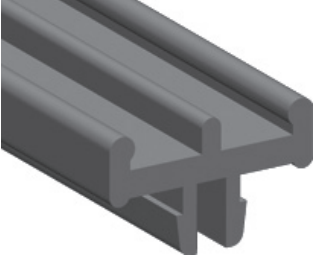

■ Teknik Detay / Technical Detail

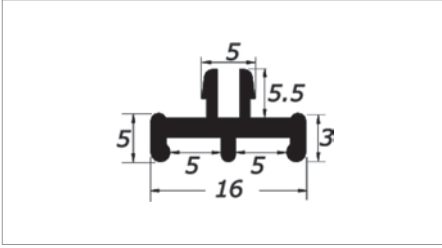

**151-0002**

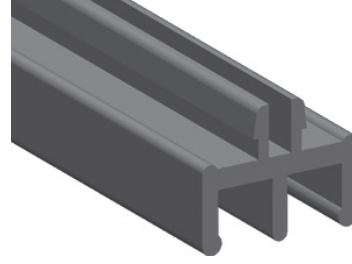
ÜST PVC PROFİL • Top PVC PROFILE

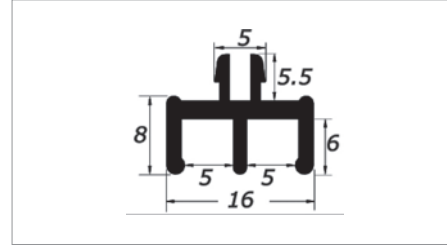

■ Teknik Detay / Technical Detail



Kod / Code No	Açıklama / Description	L (mt)	Renk / Colour	Birim / Unit		
151-0001-1600-3000	Alt PVC Profil / Bottom PVC Profile	3,00 mt	Gri / Grey	1 Adet / 1 Pcs	50	50
151-0002-1600-3000	Üst PVC Profil / Top PVC Profile	3,00 mt	Gri / Grey	1 Adet / 1 Pcs	50	50

143-1328-001

TEZGAH ÖNÜ TAPASI • BANCO RETURN TO PLUG



■ Teknik Detay / Technical Detail

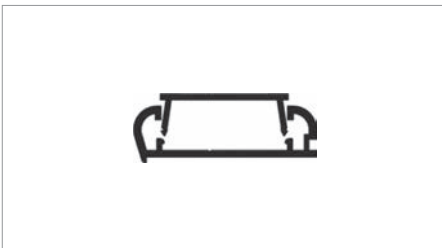

**143-1328-002**

TEZGAH ÖNÜ TAPASI • BANCO RETURN TO PLUG



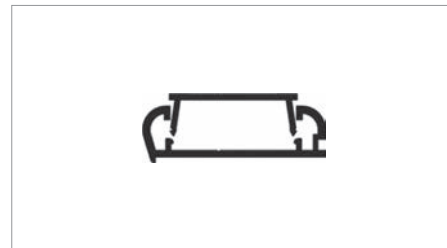

■ Teknik Detay / Technical Detail

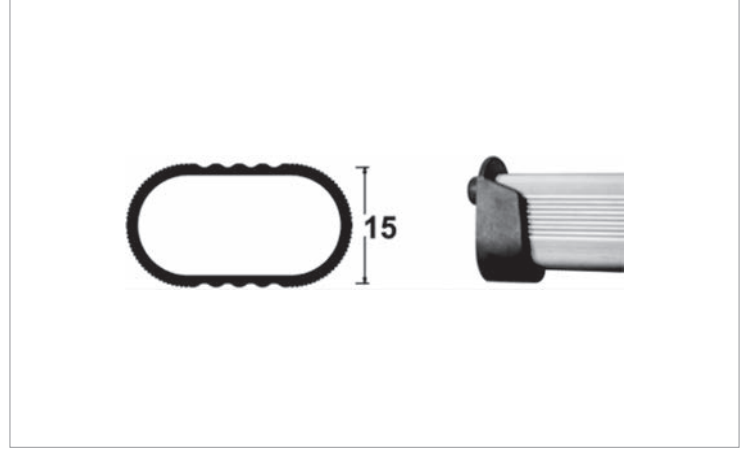
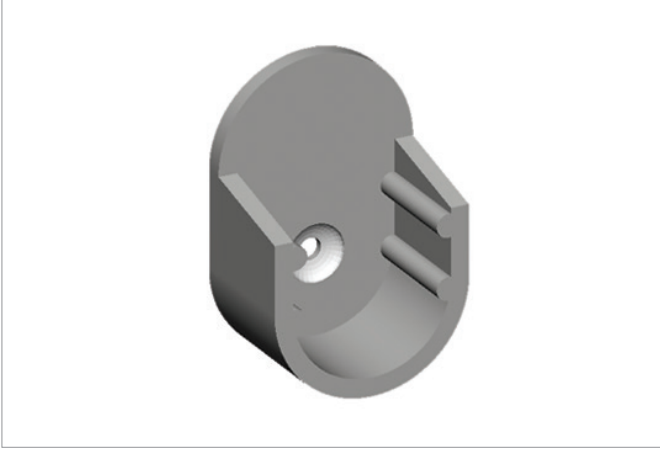

Kod / Code No	Açıklama / Description	Renk / Colour	Birim / Unit		
143-1328-1700	Tezgah Önü Tapası / Banco Return to Plug	Gri / Grey	1 Adet / 1 Pcs	20	1.920
143-1328-1800	Tezgah Önü Tapası / Banco Return to Plug	Parlak / Bright	1 Adet / 1 Pcs	20	1.920

■ Teknik Detay / Technical Detail



Kod / Code No	Açıklama / Description	Renk / Colour	Birim / Unit		
143-2413-1600	Plastik Askı Boru Flanşı / Hanger Pipe Flange	Gri / Grey	1 Adet / 1 Pcs	200	19.200

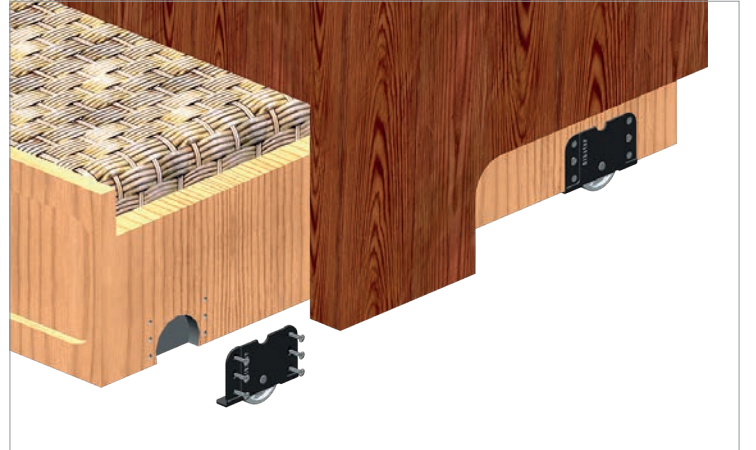

■ Teknik Detay / Technical Detail



■ Bilgi / Information

- 1 takım 4 adet mekanizmadan oluşur.
- 1 set 4 pcs.



Kod / Code No	Açıklama / Description	Renk / Colour	Birim / Unit		
143-7056-1200	120 Kg Baza Taşıyıcı Teker / Carrier Roller	Gri / Grey	4 Adet / 1 Set	24	768

■ Teknik Detay / Technical Detail

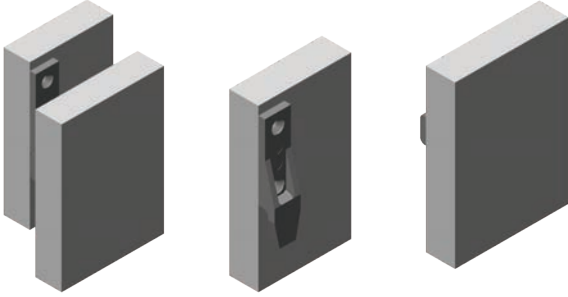
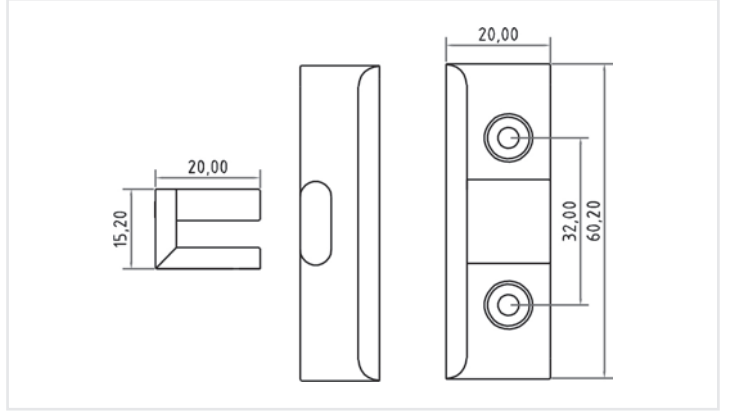

Kod / Code No	Açıklama / Description	Renk / Colour	Birim / Unit		
143-1000-1630	Panel Bileşeni / Panel Component	Siyah / Black	1 Adet / 1 Pcs	100	6000

■ Teknik Detay / Technical Detail

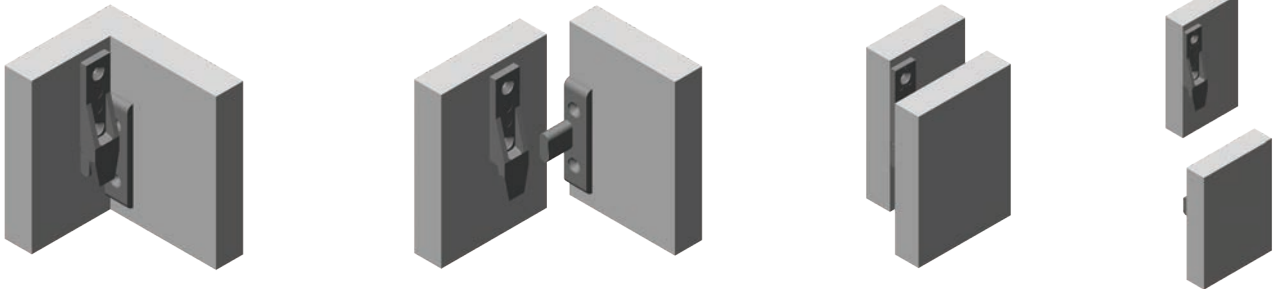
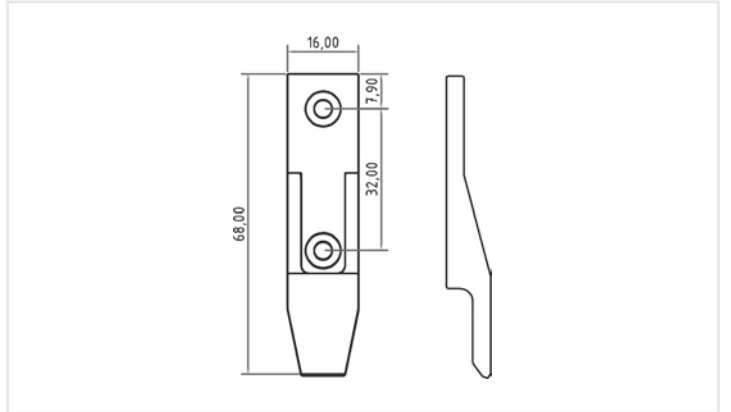

Kod / Code No	Açıklama / Description	Renk / Colour	Birim / Unit		
143-1010-1630	Panel Bileşeni / Panel Component	Siyah / Black	1 Adet / 1 Pcs	100	6000



■ Teknik Detay / Technical Detail

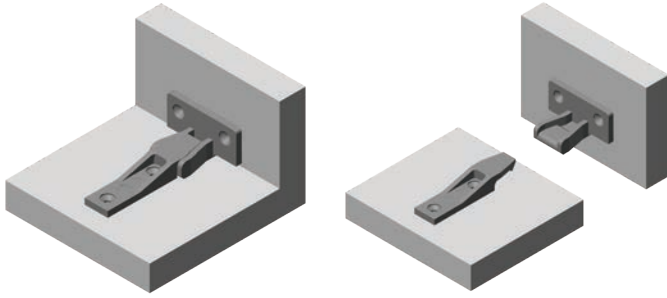
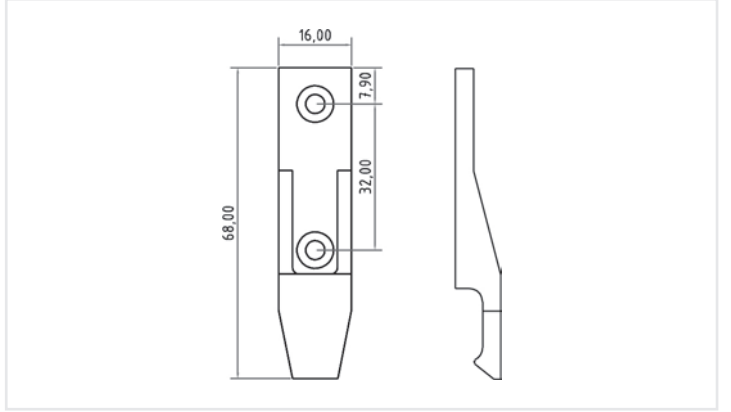



Kod / Code No	Açıklama / Description	Renk / Colour	Birim / Unit		
143-1020-1630	Panel Bileşeni / Panel Component	Siyah / Black	1 Adet / 1 Pcs	100	6000

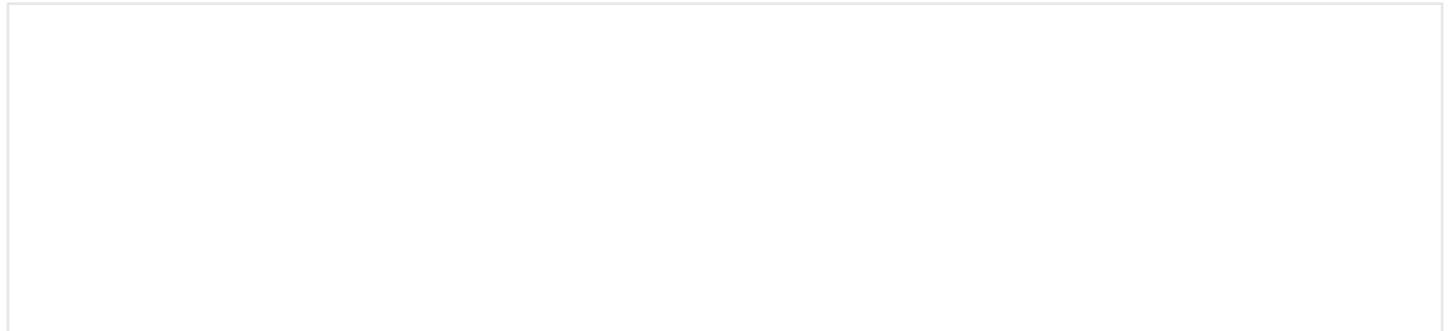
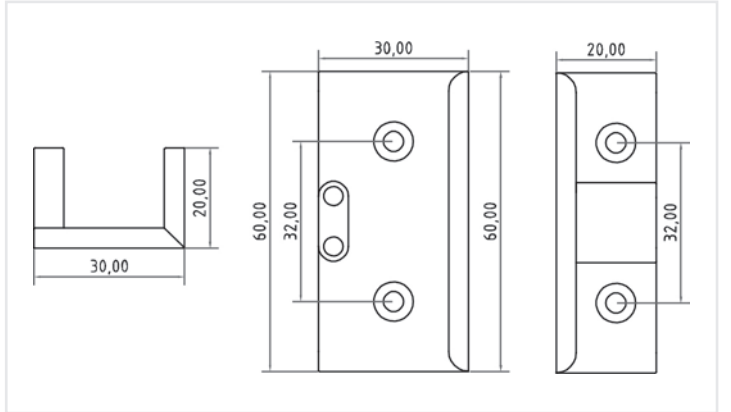

■ Teknik Detay / Technical Detail



Kod / Code No	Açıklama / Description	Renk / Colour	Birim / Unit		
143-1030-1630	Panel Bileşeni / Panel Component	Siyah / Black	1 Adet / 1 Pcs	100	6000

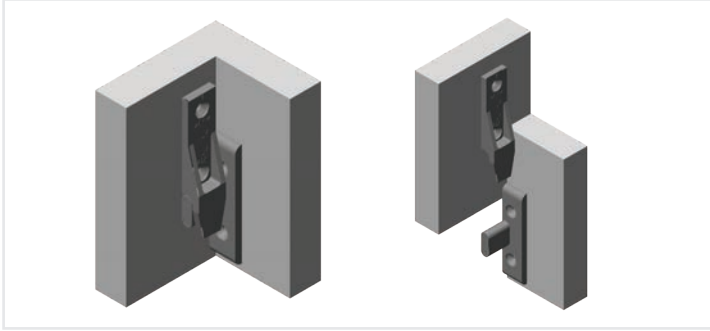
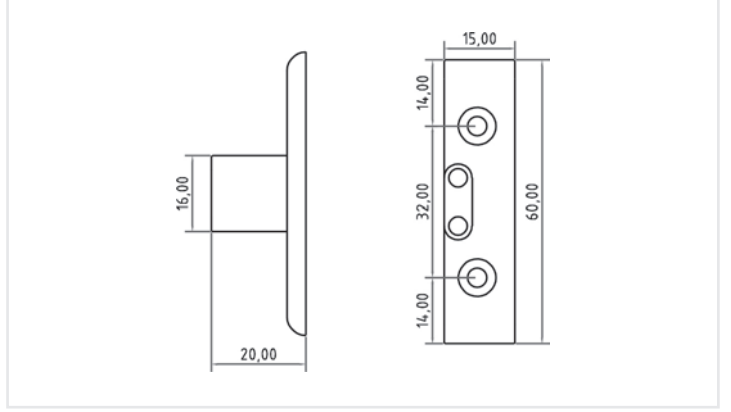

■ Teknik Detay / Technical Detail

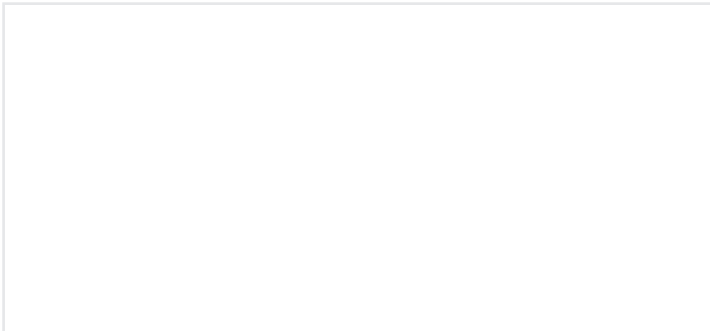
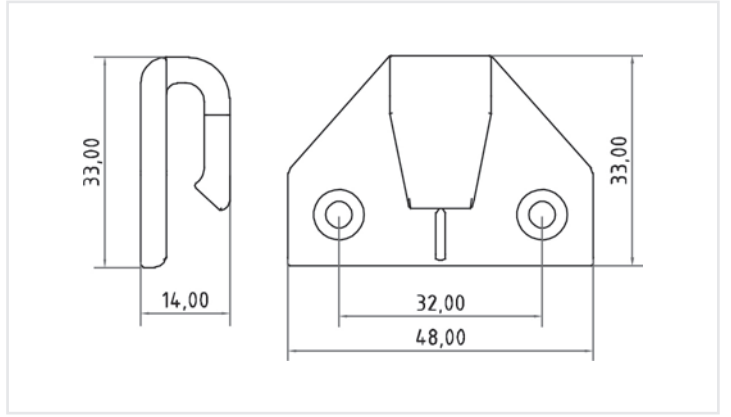
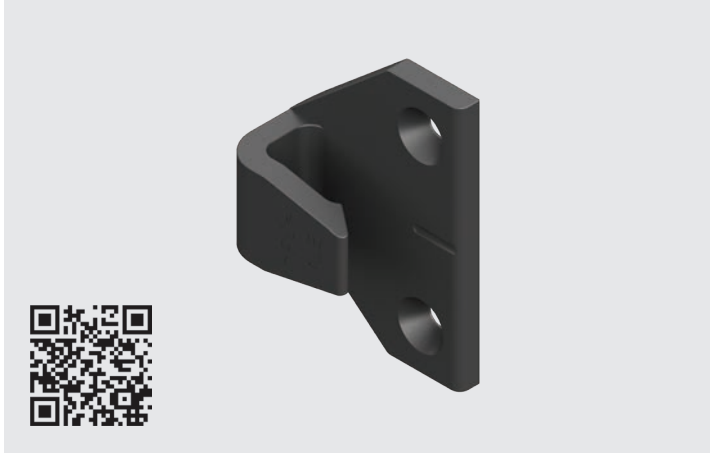

Kod / Code No	Açıklama / Description	Renk / Colour	Birim / Unit		
143-1040-1630	Panel Bileşeni / Panel Component	Siyah / Black	1 Adet / 1 Pcs	100	6000

■ Teknik Detay / Technical Detail



Kod / Code No	Açıklama / Description	Renk / Colour	Birim / Unit		
143-1050-1630	Panel Bileşeni / Panel Component	Siyah / Black	1 Adet / 1 Pcs	100	6000

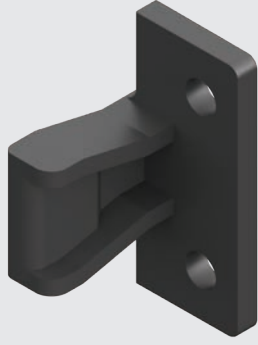

■ Teknik Detay / Technical Detail

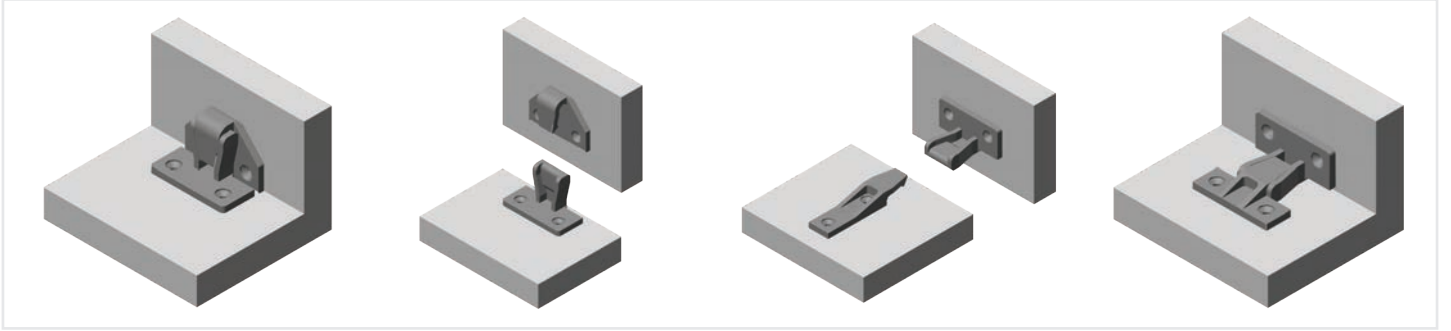
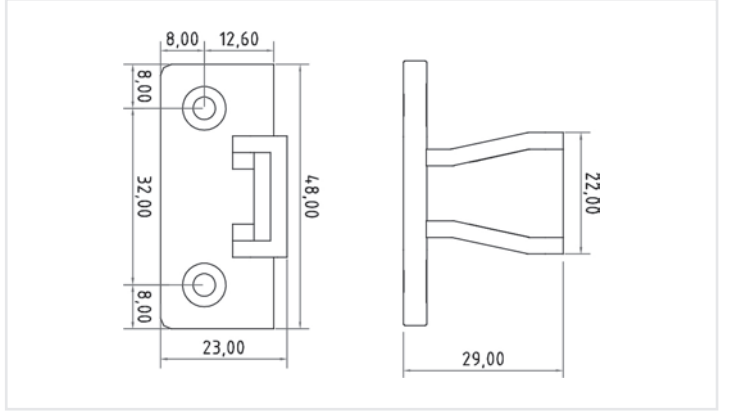

Kod / Code No	Açıklama / Description	Renk / Colour	Birim / Unit		
143-1060-1630	Panel Bileşeni / Panel Component	Siyah / Black	1 Adet / 1 Pcs	100	6000

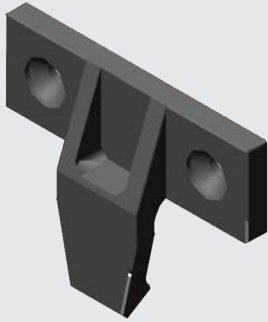

■ Teknik Detay / Technical Detail

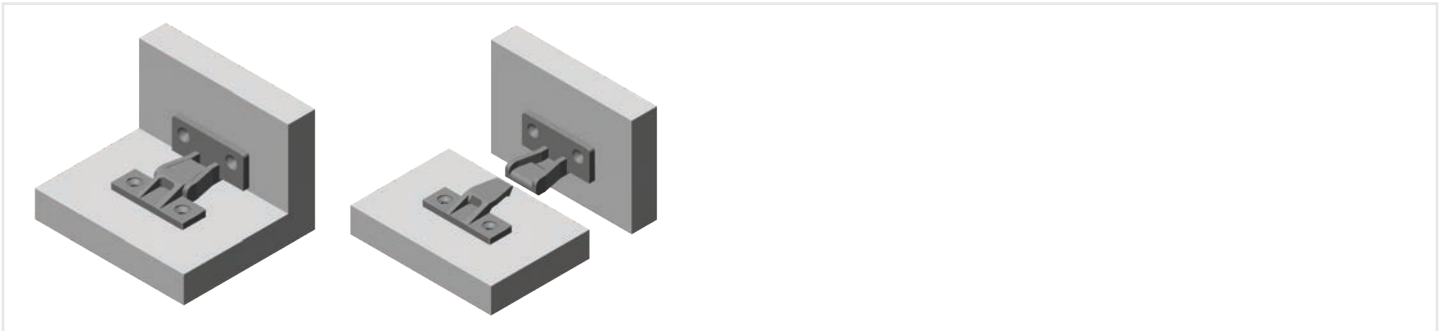
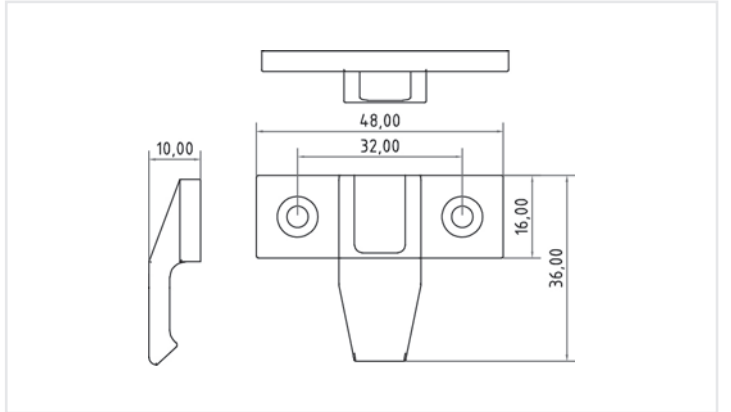

Kod / Code No	Açıklama / Description	Renk / Colour	Birim / Unit		
143-1070-1630	Panel Bileşeni / Panel Component	Siyah / Black	1 Adet / 1 Pcs	100	6000

Group 144

Feet

Koltuk ve Baza Ayakları Serisi
Furniture Feet Series



Bu serideki tüm ürünleri incelemek için
QR kodu okutabilirsiniz.

You can analyze the QR code to see all the
products in these series.

1



144-0001

2



144-0129

3



144-0115

4



144-0120

5

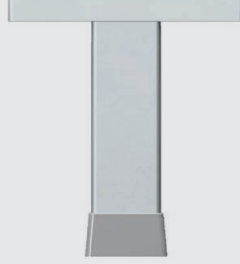

144-0121

6



144-0127

7



144-0131

8

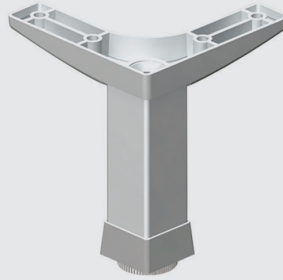

144-0123

9



144-0124

10



144-0125

11



144-0126

12



144-0132

13



144-0147

14



15

■ 144-0001 • ALÜMİNYUM TELESKOPİK STAND • ALUMINIUM TELESCOPIC STAND

■ Bilgi / Information

- * Siparişe özel Minimum 2000 adet üretilmektedir.
- * Koli içeriği 9 adettir.
- * Lütfen teklif isteyiniz.
- * Produced minimum 2.000 pcs for special order.
- * Content of the box 9 pieces.
- * Please ask to us for price offer.



Kod / Code No	Açıklama / Description	Renk / Colour	Birim / Unit		
144-0001-1410	Alüminyum Çok Amaçlı Stand / Aluminium Teleskopik Stands	Eloksal / Mat Anodized	1 Adet / 1 Pcs	6	72



■ 144-0129 • AYARLI BAZA MEKANİZMASI • FURNITURE FEET



Kod / Code No	Renk / Colour	H (cm)	Birim / Unit		
144-0129-1300-0060	Galvaniz / Galvanized	6 cm	1 Adet / 1 Pcs	50	1.600
144-0129-1300-0080	Galvaniz / Galvanized	8 cm	1 Adet / 1 Pcs	50	1.600
144-0129-1300-0100	Galvaniz / Galvanized	10 cm	1 Adet / 1 Pcs	50	1.600
144-0129-1300-0120	Galvaniz / Galvanized	12 cm	1 Adet / 1 Pcs	50	1.600

■ 144-0115 • ALÜMİNYUM SUNTA DESTEK AYAK • ALUMINIUM FURNITURE FEET • W 25 x 25 mm



Kod / Code No	Renk / Colour	H (cm)	Birim / Unit		
144-0115-1410-0050	Eloksal / Mat Anodized	5 cm	1 Adet / 1 Pcs	100	3.200
144-0115-1410-0060	Eloksal / Mat Anodized	6 cm	1 Adet / 1 Pcs	100	3.200
144-0115-1410-0080	Eloksal / Mat Anodized	8 cm	1 Adet / 1 Pcs	100	2.400
144-0115-1410-0100	Eloksal / Mat Anodized	10 cm	1 Adet / 1 Pcs	100	2.400
144-0115-1410-0120	Eloksal / Mat Anodized	12 cm	1 Adet / 1 Pcs	100	1.800
144-0115-1410-0150	Eloksal / Mat Anodized	15 cm	1 Adet / 1 Pcs	100	1.800
144-0115-1410-0200	Eloksal / Mat Anodized	20 cm	1 Adet / 1 Pcs	80	1.440

■ 144-0120 • ALÜMİNYUM BAZA KÖŞE AYAK • ALUMINIUM FURNITURE FEET • W 25 x 25 mm



Kod / Code No	Renk / Colour	H (cm)	Birim / Unit		
144-0120-1410-0060	Eloksal / Mat Anodized	6 cm	1 Adet / 1 Pcs	100	3.200
144-0120-1410-0080	Eloksal / Mat Anodized	8 cm	1 Adet / 1 Pcs	100	2.400
144-0120-1410-0100	Eloksal / Mat Anodized	10 cm	1 Adet / 1 Pcs	100	2.400
144-0120-1410-0120	Eloksal / Mat Anodized	12 cm	1 Adet / 1 Pcs	100	1.800
144-0120-1410-0150	Eloksal / Mat Anodized	15 cm	1 Adet / 1 Pcs	60	1.080
144-0120-1410-0200	Eloksal / Mat Anodized	20 cm	1 Adet / 1 Pcs	60	1.080
144-0120-1410-0220	Eloksal / Mat Anodized	22 cm	1 Adet / 1 Pcs	60	1.080
144-0120-1410-0250	Eloksal / Mat Anodized	25 cm	1 Adet / 1 Pcs	60	1.080



■ 144-0121 • ALÜMİNYUM BAZA ORTA AYAK • ALUMINIUM FURNITURE FEET • W 25 x 25 mm



Kod / Code No	Renk / Colour	H (cm)	Birim / Unit		
144-0121-1410-0060	Eloksal / Mat Anodized	6 cm	1 Adet / 1 Pcs	50	1.600
144-0121-1410-0080	Eloksal / Mat Anodized	8 cm	1 Adet / 1 Pcs	50	1.600
144-0121-1410-0100	Eloksal / Mat Anodized	10 cm	1 Adet / 1 Pcs	50	1.200
144-0121-1410-0120	Eloksal / Mat Anodized	12 cm	1 Adet / 1 Pcs	50	1.200
144-0121-1410-0150	Eloksal / Mat Anodized	15 cm	1 Adet / 1 Pcs	50	900
144-0121-1410-0200	Eloksal / Mat Anodized	20 cm	1 Adet / 1 Pcs	50	900
144-0121-1410-0220	Eloksal / Mat Anodized	22 cm	1 Adet / 1 Pcs	50	900
144-0121-1410-0250	Eloksal / Mat Anodized	25 cm	1 Adet / 1 Pcs	50	900



■ 144-0127 • ALÜMİNYUM BAZA AYAK • ALUMINIUM FURNITURE FEET • Ø 30 mm



Kod / Code No	Renk / Colour	H (cm)	Birim / Unit		
144-0127-1410-0060	Eloksal / Mat Anodized	6 cm	1 Adet / 1 Pcs	100	3.200
144-0127-1410-0080	Eloksal / Mat Anodized	8 cm	1 Adet / 1 Pcs	100	2.400
144-0127-1410-0100	Eloksal / Mat Anodized	10 cm	1 Adet / 1 Pcs	100	2.400
144-0127-1410-0120	Eloksal / Mat Anodized	12 cm	1 Adet / 1 Pcs	100	1.800
144-0127-1410-0150	Eloksal / Mat Anodized	15 cm	1 Adet / 1 Pcs	100	1.800
144-0127-1410-0200	Eloksal / Mat Anodized	20 cm	1 Adet / 1 Pcs	50	900
144-0127-1410-0220	Eloksal / Mat Anodized	22 cm	1 Adet / 1 Pcs	50	900
144-0127-1410-0250	Eloksal / Mat Anodized	25 cm	1 Adet / 1 Pcs	50	900



■ 144-0131 • ALÜMİNYUM BAZA AYAK • ALUMINIUM FURNITURE FEET
W 38 x 38 mm



Kod / Code No	Renk / Colour	H (cm)	Birim / Unit		
144-0131-1410-0050	Eloksal / Mat Anodized	5 cm	1 Adet / 1 Pcs	100	1.800
144-0131-1410-0060	Eloksal / Mat Anodized	6 cm	1 Adet / 1 Pcs	100	1.800
144-0131-1410-0080	Eloksal / Mat Anodized	8 cm	1 Adet / 1 Pcs	100	1.800
144-0131-1410-0100	Eloksal / Mat Anodized	10 cm	1 Adet / 1 Pcs	100	1.800
144-0131-1410-0120	Eloksal / Mat Anodized	12 cm	1 Adet / 1 Pcs	100	1.800
144-0131-1410-0150	Eloksal / Mat Anodized	15 cm	1 Adet / 1 Pcs	50	900
144-0131-1410-0200	Eloksal / Mat Anodized	20 cm	1 Adet / 1 Pcs	50	900
144-0131-1410-0220	Eloksal / Mat Anodized	22 cm	1 Adet / 1 Pcs	50	900
144-0131-1410-0250	Eloksal / Mat Anodized	25 cm	1 Adet / 1 Pcs	50	900



■ 144-0123 • ALÜMİNYUM BAZA AYAK • ALUMINIUM FURNITURE FEET • W 25 x 25 mm



Kod / Code No	Renk / Colour	H (cm)	Birim / Unit		
144-0123-1410-0060	Eloksal / Mat Anodized	6 cm	1 Adet / 1 Pcs	50	1.600
144-0123-1410-0080	Eloksal / Mat Anodized	8 cm	1 Adet / 1 Pcs	50	1.600
144-0123-1410-0100	Eloksal / Mat Anodized	10 cm	1 Adet / 1 Pcs	50	1.600
144-0123-1410-0120	Eloksal / Mat Anodized	12 cm	1 Adet / 1 Pcs	50	1.200
144-0123-1410-0150	Eloksal / Mat Anodized	15 cm	1 Adet / 1 Pcs	50	1.200
144-0123-1410-0200	Eloksal / Mat Anodized	20 cm	1 Adet / 1 Pcs	50	1.200

■ 144-0124 • ALÜMİNYUM ORTA AYAK • ALUMINIUM FURNITURE FEET • W 25 x 25 mm



Kod / Code No	Renk / Colour	H (cm)	Birim / Unit		
144-0124-1410-0060	Eloksal / Mat Anodized	6 cm	1 Adet / 1 Pcs	50	1.600
144-0124-1410-0080	Eloksal / Mat Anodized	8 cm	1 Adet / 1 Pcs	50	1.600
144-0124-1410-0100	Eloksal / Mat Anodized	10 cm	1 Adet / 1 Pcs	50	1.600
144-0124-1410-0120	Eloksal / Mat Anodized	12 cm	1 Adet / 1 Pcs	50	1.200
144-0124-1410-0150	Eloksal / Mat Anodized	15 cm	1 Adet / 1 Pcs	50	1.200
144-0124-1410-0200	Eloksal / Mat Anodized	20 cm	1 Adet / 1 Pcs	50	1.200

■ 144-0125 • ALÜMİNYUM AYARLI BAZA AYAK • FURNITURE FEET • Ø 30 mm



Kod / Code No	Renk / Colour	H (cm)	Birim / Unit		
144-0125-1410-0060	Eloksal / Mat Anodized	6 cm	1 Adet / 1 Pcs	50	1.600
144-0125-1410-0080	Eloksal / Mat Anodized	8 cm	1 Adet / 1 Pcs	50	1.600
144-0125-1410-0100	Eloksal / Mat Anodized	10 cm	1 Adet / 1 Pcs	50	1.600
144-0125-1410-0120	Eloksal / Mat Anodized	12 cm	1 Adet / 1 Pcs	50	1.200
144-0125-1410-0150	Eloksal / Mat Anodized	15 cm	1 Adet / 1 Pcs	50	1.200
144-0125-1410-0200	Eloksal / Mat Anodized	20 cm	1 Adet / 1 Pcs	50	1.200

■ 144-0126 • ALÜMİNYUM AYARLI BAZA ORTA AYAK • FURNITURE FEET • Ø 30 mm



Kod / Code No	Renk / Colour	H (cm)	Birim / Unit		
144-0126-1410-0060	Eloksal / Mat Anodized	6 cm	1 Adet / 1 Pcs	50	1.600
144-0126-1410-0080	Eloksal / Mat Anodized	8 cm	1 Adet / 1 Pcs	50	1.600
144-0126-1410-0100	Eloksal / Mat Anodized	10 cm	1 Adet / 1 Pcs	50	1.600
144-0126-1410-0120	Eloksal / Mat Anodized	12 cm	1 Adet / 1 Pcs	50	1.200
144-0126-1410-0150	Eloksal / Mat Anodized	15 cm	1 Adet / 1 Pcs	50	1.200
144-0126-1410-0200	Eloksal / Mat Anodized	20 cm	1 Adet / 1 Pcs	50	1.200

■ 144-0132 • ALÜMİNYUM BAZA AYAK • ALUMINIUM FURNITURE FEET • W 40 x 40 mm



Kod / Code No	Renk / Colour	H (cm)	Birim / Unit		
144-0132-1410-0060	Eloksal / Mat Anodized	6 cm	1 Adet / 1 Pcs	60	1.920
144-0132-1410-0080	Eloksal / Mat Anodized	8 cm	1 Adet / 1 Pcs	60	1.920
144-0132-1410-0100	Eloksal / Mat Anodized	10 cm	1 Adet / 1 Pcs	60	1.920
144-0132-1410-0120	Eloksal / Mat Anodized	12 cm	1 Adet / 1 Pcs	60	1.440
144-0132-1410-0150	Eloksal / Mat Anodized	15 cm	1 Adet / 1 Pcs	60	1.440
144-0132-1410-0200	Eloksal / Mat Anodized	20 cm	1 Adet / 1 Pcs	60	1.440

■ 144-0147 • ALÜMİNYUM BAZA AYAK • ALUMINIUM FURNITURE FEET • Ø 50 mm













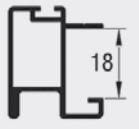
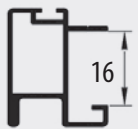
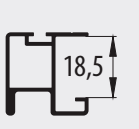
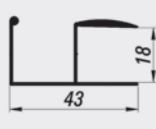
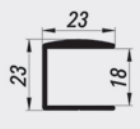
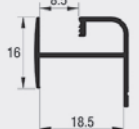
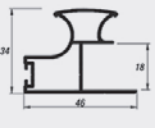
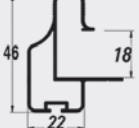
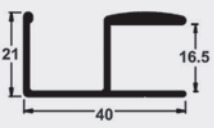
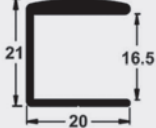
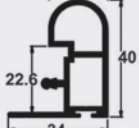
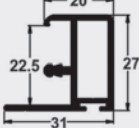
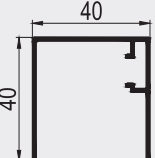
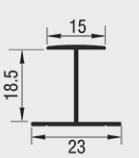
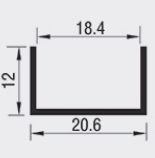
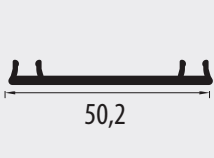
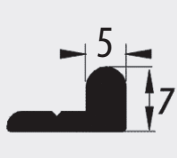
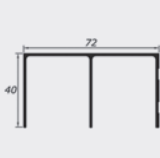
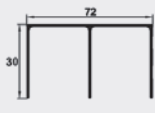

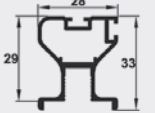

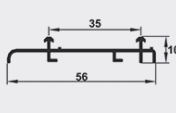
Kod / Code No	Renk / Colour	H (cm)	Birim / Unit		
144-0147-1410-0060	Eloksal / Mat Anodized	6 cm	1 Adet / 1 Pcs	60	1.920
144-0147-1410-0080	Eloksal / Mat Anodized	8 cm	1 Adet / 1 Pcs	40	1.280
144-0147-1410-0100	Eloksal / Mat Anodized	10 cm	1 Adet / 1 Pcs	40	1.280
144-0147-1410-0120	Eloksal / Mat Anodized	12 cm	1 Adet / 1 Pcs	40	960
144-0147-1410-0150	Eloksal / Mat Anodized	15 cm	1 Adet / 1 Pcs	40	960
144-0147-1410-0200	Eloksal / Mat Anodized	20 cm	1 Adet / 1 Pcs	20	480

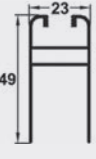
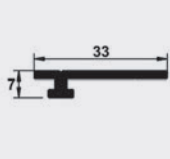
Group 150

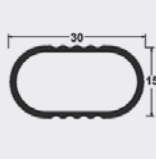
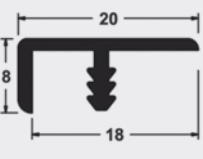
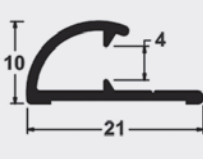
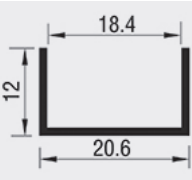
Alüminyum Profiller

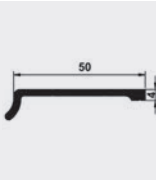
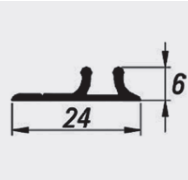
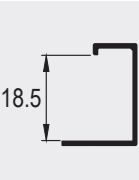
Aluminium Profiles

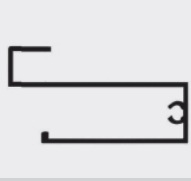
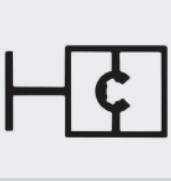

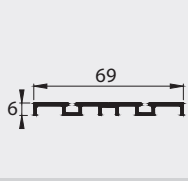
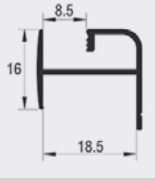
					
150-2900	150-2905	150-2800	150-2523	150-2524	150-2940
					
150-2600	150-2500	150-2710	150-2711	150-2810	150-2811
					
150-2911	150-2930	150-2920	150-7109	150-7130	150-1853
					
150-1802	150-1852	150-1804	150-1806	150-1803	150-1813
					
150-1807	150-4405	150-4420	150-2413	150-1327	150-3615
					
150-2920	150-4425	150-4400	150-4410	150-7102	150-1420
					
150-2000	150-2001	150-2002	150-2003	150-2005	150-2940

Not : Bu sayfada bulunan profiller stok tutulmamaktadır.

Siparişe özel olarak üretilmektedir.

Alüminyum renk tercihleri için müşteri temsilcilerimizle görüşebilirsiniz.

Minimum sipariş tutarı her profil için 500 kg karşılığı olmalıdır.

Termin süreleri için ayrıca bilgi talep edebilirsiniz.

Note : Profiles are on this page has not keeping stock.

It is produced specially for the orders.

You can contact our customer representatives for special colour alternatives.

Minimum orders quantity should be 500 kg for each profile.

For the production time you can request information from us.

Group 160

HingeTech

Menteşe Serisi

Hinge Series



Bu serideki tüm ürünleri incelemek için QR kodu okutabilirsiniz.

You can analyze the QR code to see all the products in these series.



SINCE 1976	 Bearing Systems	EN 1527 100.000 CYCLES TEST 	 The Sliding System
---------------	------------------------	--	------------------------------

HingeTech Series



HingeTech 0800

160-0800

80 KG GİZLİ KAPI MENTEŞESİ
80 KG CONCEALED HINGE

Yeni Ürün
New Product



Kod / Code No	Açıklama / Description	Renk / Colour	Birim / Unit		
160-0800-1210	80 Kg Gizli Menteşe / Concealed Hinge	Antrasit / Anthracite	1 Adet / 1 Pcs.	-	-



Kod / Code No	Açıklama / Description	Renk / Colour	Birim / Unit		
160-0800-1222	80 Kg Gizli Menteşe / Concealed Hinge	Mat Siyah / Matte Black	1 Adet / 1 Pcs.	-	-

Kod / Code No	Açıklama / Description	Renk / Colour	Birim / Unit		
160-0800-1232	80 Kg Gizli Menteşe / Concealed Hinge	Gri / Gray	1 Adet / 1 Pcs.	-	-

Kod / Code No	Açıklama / Description	Renk / Colour	Birim / Unit		
160-0800-1250	80 Kg Gizli Menteşe / Concealed Hinge	Bronz / Bronze	1 Adet / 1 Pcs.	-	-



HingeTech 0800

<p>SINCE 1976</p>	 <p>Bearing Systems</p>	<p>EN 1527 100.000 CYCLES TEST</p> 	<p>(R) The Sliding System</p>
-----------------------	--	--	--



HingeTech

ÇELİK MENTEŞE • STEEL HINGE



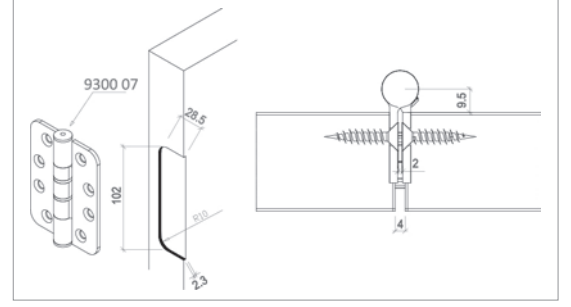

■ Teknik Detay / Technical Detail



■ Bilgi / Information

- Taşıma kapasitesi, 1 kanat için 3 menteşe kullanılarak 80 kg kadardır.
- Carrying capacity : For 1 door 3 hinges using maximum to 80 kg

Kod / Code No	Açıklama / Description	Renk / Colour	Birim / Unit		
122-9300-1410-507	Çelik Menteşe / Steel Hinge	Galvaniz / Galvanized	1 Adet / 1 Pcs	50	4800

HingeTech

ÇELİK MENTEŞE • STEEL HINGE

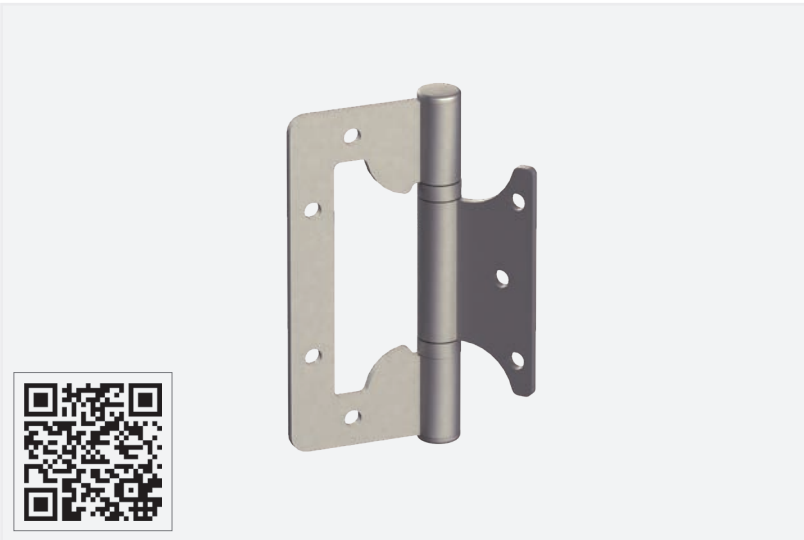

■ Teknik Detay / Technical Detail

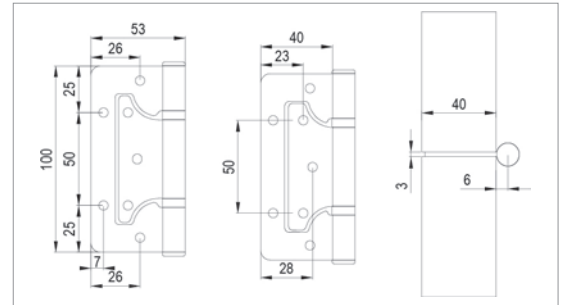

■ Bilgi / Information

- Taşıma kapasitesi, 1 kanat için 3 menteşe kullanılarak 40 kg kadardır.
- Carrying capacity : For 1 door 3 hinges using maximum to 40 kg

Kod / Code No	Açıklama / Description	Renk / Colour	Birim / Unit		
122-9061-1300-505	Çelik Menteşe / Steel Hinge	Galvaniz / Galvanized	1 Adet / 1 Pcs	50	4800



SINCE 1976	 Bearing Systems	EN 1527 100.000 CYCLES TEST 	 The Sliding System
---------------	---	---	---



Domino 180

SETBOX

PAKETLEME • PACKAGING



Mekanizma ve Profiller aynı ambalaj içerisinde bulunur.
Mechanism and Profiles are in the same package.



Özel dizayn edilmiş straforlar ile dayanıklılık sağlanır.
Durability is provided with specially designed styrofoam.



Perakende satışlar için şık kutu görünümü sunar.
Offers a stylish box view for retail sales.



Malzeme tanıtm etiketi ile izlenebilirlik sağlar.
Provides traceability with material identification label.



Pratik depolama ve stok kolaylığı sağlar.
Provides practical storage and stock convenience.



Kolay ulaşılabilirlik ve ergonomik taşıma sağlar.
Provides easy accessibility and ergonomic transport.

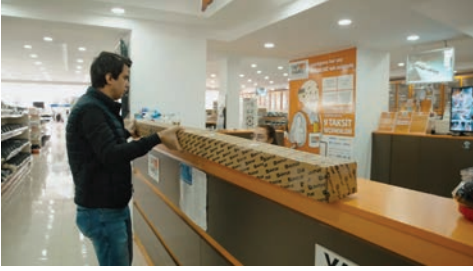

Perakende satışlarda kolaylık sağlar.
It provides convenience in retail sales.



QR kod ile stok hatalarını önler.
Prevents inventory errors with QR code.



Lojistik esnasında hasar ve deformasyonları önler.
Prevents damage and deformations during logistics.



Dayanıklı ambalaj ve hasarsız ürün imkanı sunar.
It offers durable packaging and undamaged product.



Eksiksiz ürün ve montaj kolaylığı sağlar.
Provides complete product and ease of assembly.

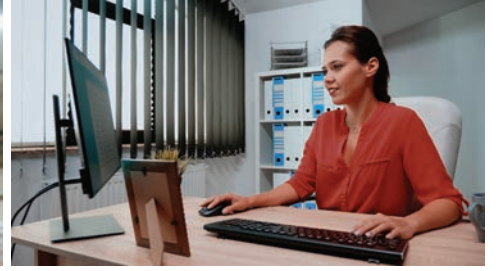

E-ticaret imkanı sunar.
Offers e-commerce opportunity.



SETBOX

PAKETLEME • PACKAGING

STANDART PAKETLEME / STANDARD PACKAGING



Standart Sevkiyat Düzenimiz ;

Mekanizma ve ray profilleri, ürüne göre değişen bağ ve koli adetlerinde müşterilerimize sevk edilmektedir.

Standard shipment process ;

Mechanism and rail profiles are packaging and shipping to our customers in changing laps and carton ties and parcels various according to the product.

SETBOX PAKETLEME / SETBOX PACKAGING



Değerli İş Ortağımız ;

Sizlere yeni hizmetimiz SETBOX'ı tanıtmak istiyoruz. Paketleme ve sevkiyat süreçlerinize hız katacağını düşündüğümüz SETBOX sistemi, tek paket içerisinde 1 dolaplık ürünü içermektedir.

SETBOX Paketleme ;

Sürme sistemler için düşünülmüş bu paketleme modelinde, ray profilleri ve mekanizma tek karton ambalaj içerisinde, köpüklerle desteklenmiş olarak 1 set halinde sevk edilmektedir.

Kısaca ; Dolap için 1 setbox içerisinde ; 2 kapak mekanizma + üst ray + alt ray bulunmaktadır.

Neden SETBOX ;

- Bildiğiniz gibi sürgü sistemleri çok bileşenli ürünlerdir. Tek paketleme sayesinde hatasız ve noksansız sevkiyat gerçekleştirilebilir.
- Depolama açısından kolaylık sağlar.
- Değişken ve benzer ray profillerindeki stok karışıklığını önler. Stoklama maliyetlerinizi düşürür.
- Sevkiyat hazırlık sürenizi kısaltır.
- Ürünlerinizi koli ve köpük ambalajı sayesinde daha uzun süreli muhafaza edebilir ve dış darbelerle göre koruyabilirsiniz.
- İnternet üzerinden E-satış yapan firmalar için sevkiyat kolaylığı sağlar.

Detay Bilgiler ;

- Farklı boy ve ürün seçenekleri sebebiyle ürünler siparişe özel paketlenmektedir.
- Stokta hazır ürün bulunmamaktadır.
- Ray boyları 2 mt , 2.5 mt, 3 mt olarak uygulanabilir.
- Kapılarda 1 kapı sistemi ve üst ray paketlenir. İstenirse alın kapama profili paket içerisine ilave edilebilir.
- Setbox sistemi ürün fiyatı üzerine paket maliyeti eklenerek sunulur.

Ürüne özel minimum paketleme miktarı ve fiyat teklifi için müşteri temsilciniz ile temasa geçebilirsiniz.

Dear Business Partner ;

We would like to introduce our new service SETBOX. SETBOX system which we think will add speed to your packaging and shipment process, includes 1 set sliding systems product in one package

SETBOX Packaging ;

In this packaging model for sliding systems , will be shipping 1 set mechanism with rail profiles and inside one carton package and supporting with foam.

Shortly; For wardrobe 1 setbox including ; 2 doors mechanism + Top rail + bottom rail

Why SETBOX ;

- As you know, sliding systems are multi-component products
- Easy to storage
- Its prevent to stock confusing for similar and variable profiles. It will reduce of your stocking cost
- Will be positive effect and will be shorten to your shipment time
- You can protect your products for longer periods of time and protect them against to external damage because of carton and foam packaging
- Setbox product give advantage for shipment in online sales

Detailed Informations ;

- The orders can be make special packaging because of different size product and mechanism
- There is no ready product in our stock
- Rail size can be apply 2 mt , 2.5 mt , 3 mt
- For door , 1 door mechanism and Top rail packaging together. If need Closure Profile can be add inside the setbox
- Setbox system product included packaging cost.

You can contact your customer representative for special product minimum specific packaging and price offer.



Çalışma Koşulları

WORKING CONDITIONS

■ Genel Bilgiler

- Ürünlerimiz; patentli, faydalı model ve endüstriyel tasarım tescil belgelidir.
- Fiyatlarımıza KDV dahil değildir.
- ALBATUR önceden haber vermeksizin fiyat ve satış şartlarını değiştirme hakkını saklı tutar.
- Her yeni fiyat listesi bir öncekini geçersiz kılar.
- Siparişini teyid ederek kesinleşmiş müşterimiz, çalışma koşullarımızı kabul etmiş sayılır.
- Bu fiyat listesinde oluşabilecek tipografik hatalardan firmamız sorumlu değildir.
- ALBATUR önceden haber vermeksizin ürünlerinde dizayn, renk ve hammadde özelliklerini değiştirme hakkını saklı tutar.
- Ürün broşürümüzde, albaturas.com web sitemizde ve kataloglarda verilen teknik ölçüler tavsiye niteliğinde olup, ür-ge sonrasında değişkenlik gösterebilir.
- ALBATUR 'un yazılı izni olmadan katalog ürünlerine ait herhangi bir görüntü kopyalanamaz veya kullanılamaz.
- Ürün paketlemelerinde koli, bağ, palet ölçü ve miktarlarını değiştirme hakkımız saklıdır.
- Firmamız sistemin bir parçası olan ürünlere ilişkin teklî satış yapmama hakkına sahiptir.
- Ödemesi alınmamış siparişler için sevk günündeki fiyatlar geçerlidir.

■ Sipariş Alış Düzeni ve Sevkiyat Düzeni

- Siparişler, yazılı olarak mail veya fax yoluyla firmamıza ulaştırmalı ve teyid almalıdır. Aksi durumda oluşabilecek zarar ve gecikmeden firmamız sorumlu değildir.
- Koli, kutu ve paketleme adetlerine uygun olarak siparişler verilmelidir. Aksi durumda gelen siparişler bağ ve koliye tamamlanmaktadır.
- Stokta bulunmayan ürünler için hammadde tedariki yapılır ve üretim planına alınır.
- Özel siparişlerde ödeme alındıktan sonra üretim yapılır.
- Özel siparişlerde teknik detaylar, renk ve ölçü tam olmalıdır. ALBATUR'dan kaynaklanabilecek kusur dışında iade kabul edilmez.
- Siparişler ödeme önceliği ve sipariş tarihi dikkate alınarak sevk edilir.

■ Ödeme Düzeni

- Satışlarımız kredi kartı, havale veya DBS Sistemiyle ile tahsil edilir.
- Ödemesi alınmayan siparişler sevk edilemez.
- Karşılıksız çeklerin ödemesi 7 günü geçtiği takdirde aylık %3 finansman farkı uygulanır.
- Tüm siparişlerde sipariş bedelinin ödenmesi öncelikli edim olup, sipariş miktarının tümünün veya bir kısmının teslim edilmediği gerekçesi ile ödeme yapmaktan imtina edilemez.
- Siparişlerin sevk edilen tutarı kadar tahsilat yapılır. Sipariş miktarının tamamlanması istenilerek ödemeler şarta bağlanmaz.
- Siparişlerde; ALBATUR kataloğundaki sipariş kodu, varsa rengi, ölçüleri eksiksiz ve tam olmalıdır.

■ Nakliye Düzeni

- Ürünlerin teslim yeri Bursa'daki üretim tesisleridir.
- Müşteri ile karşılıklı mutabık kalınan kargo veya nakliye firmalarına verilmiş mallar müşteriye teslim edilmiş sayılır.
- Siparişlerin, nakliye bedeli ve sorumluluğu müşteriye aittir. Nakliye sırasında doğacak aksaklıklardan ALBATUR sorumlu tutulamaz.
- Müşteri tarafından nakliye şirketi belirtilmediği takdirde, anlaşmalı olduğumuz nakliye firmaları ile sevkiyat yapılmaktadır.
- İstenildiği takdirde ürünler müşteri adına bedeli mukabili sigorta ettirilebilir.
- Müşterimiz, ürünlerini nakliye şirketinden teslim alırken eksik veya hasar durumunu mutlaka kontrol etmelidir. Eğer bir aksaklık var ise nakliye görevlisine o anda tutanak tutturmalıdır. Teslimat fişi imzalandıktan sonra nakliye şirketleri hasar tazmini yapmamaktadır. Müşteri, hasarını nakliye şirketinden talep etmelidir. Tutanağı düzenlenmiş eksik veya hasarlı ürün teslimlerindeki sigorta konularında gerekli bilgilendirme, talep edilmesi durumunda firmamızdan alınabilir.

■ İade Düzeni

- İmalat hatalı ürünler ALBATUR'a bildirilmeli ve onayı alınarak 15 gün içinde iade edilmelidir.
İade edilmeyen ürünler tekrar geri alınmaz ve değiştirilemez.
İade edilecek ürünler ALBATUR'un anlaşmalı kargo veya nakliye firmaları ile yapılmalıdır.
- Sistem ürünlerimizin tüm parçaları firmamızdan temin edilmeyen ürünlerde yaşanabilecek aksaklıklardan firmamız sorumlu değildir.
- Siparişe özel üretilen ürünler iade alınmaz.
- Ürün modeli, dizaynı değişmiş veya listeden çıkarılmış ürünler iade alınmaz.
- İade gönderilmeden önce firmamızdan iade onayı alınmalıdır.
Onay alınmayan ve önceden bilgisi verilmeden gönderilen iade ürünlerin firmamızca giriş kabulü yapılmaz.

Unit 1 - Kullanım Şekli - Category of use No grade identified for these products

Unit 2 - Dayanıklılık (Çalışma/Tur Süreleri) - Durability / Durability is measured by the number of openings (cycles) performed by the gear under standard test conditions. All parts must remain in service-able condition throughout the test and no adjustment is allowed. Fittings are required to pass the Initial Friction Test (Unit 9) both before and after the durability test. The six grades are :

grade 1 : 2 500 cycles

grade 2 : 5 000 cycles

grade 3 : 10 000 cycles

grade 4 : 25 000 cycles

grade 5 : 50 000 cycles

grade 6 : 100 000 cycles

Unit 3 - Kapı Ağırlığı - Door Weight / Four grades are identified : The four grades are :

grade 1 : up to 50 kg

grade 2 : from 51 to 100 kg

grade 3 : from 101kg to 330 kg

Unit 4 - Yangın Direnci - Fire Resistance / Two grades of fire resistance are identified :

grade 0 : not approved for use on fire door assemblies

grade 1 : suitable for use on fire door assemblies

Unit 5 - Emniyet - Safety / No requirements

Unit 6 - Korozyon Dayanımı - Corrosion resistance - Five possible grades are identified, clasified in accordance with EN 1670 , Grade 0 also applies to products for which a defined corrosion resistance is not relevant and to those that have not been tested

grade 0 : no defined corrosion resistance

grade 1 : low resistance

grade 2 : moderate resistance

grade 3 : high resistance

grade 4 : very high resistance

Unit 7 - Güvenlik - Security / No requirements

Unit 8 - Katagori - Category of door / Three types of door are covered by the standard :

grade 1 : straight sliding door

grade 2 : sliding/folding door

grade 3 : multipanel foding door

Unit 9 - İlk Kalkış Momenti - Initial Friction / This is the measurement of amount of force required to start the movement of door .

The grade allocated is variable depending upon the weight of the door :

Weight	0-50 kg	51-100 kg	101-330 kg	over 330 kg
grade 1	50 N	80 N	100 N	5 %*
grade 2	40 N	60 N	5 %*	4 %*
grade 3	30 N	40 N	4 %*	3 %*

- Albatür Sürgü Sistemleri EN 1527 standartlarına uygun olarak test edilmiştir.
- Albatür Sliding Sytems have been tested in according with the standart of EN 1527 test requirements.

Properties Product Index	Unit 1	Unit 2	Unit 3	Unit 4	Unit 5	Unit 6	Unit 7	Unit 8	Unit 9
101 G01	-	Grade 4 (25 000 cycles)	Grade 1 (up to 50 kg)	0	-	0	-	Grade 1	Grade 3
102 G01	-	Grade 5 (50 000 cycles)	Grade 2 (51-100 kg)	0	-	0	-	Grade 1	Grade 2
103 G01	-	Grade 5 (50 000 cycles)	Grade 2 (51-100 kg)	0	-	0	-	Grade 1	Grade 3
104 G01	-	Grade 4 (25 000 cycles)	Grade 1 (up to 50 kg)	0	-	0	-	Grade 1	Grade 3
105 G01	-	Grade 5 (50 000 cycles)	Grade 1 (up to 50 kg)	0	-	0	-	Grade 1	Grade 3
108 G01	-	Grade 5 (50 000 cycles)	Grade 1 (up to 50 kg)	0	-	0	-	Grade 1	Grade 3
109 G01	-	Grade 5 (50 000 cycles)	Grade 1 (up to 50 kg)	0	-	0	-	Grade 1	Grade 3
110 G01	-	Grade 4 (25 000 cycles)	Grade 1 (up to 50 kg)	0	-	0	-	Grade 1	Grade 3
117 G01	-	Grade 5 (50 000 cycles)	Grade 1 (up to 50 kg)	0	-	0	-	Grade 1	-
118 G01	-	-	Grade 2 (51-100 kg)	1	-	0	-	Grade 1-2-3	-
120 G01	-	Grade 5 (50 000 cycles)	Grade 2 (51-100 kg)	0	-	0	-	Grade 1	Grade 1
121 G01	-	Grade 5 (50 000 cycles)	Grade 2 (51-100 kg)	0	-	0	-	Grade 1	Grade 1
122 G01	-	Grade 4 (25 000 cycles)	Grade 2 (51-100 kg)	0	-	0	-	Grade 3	Grade 3
123 G01	-	Grade 5 (50 000 cycles)	Grade 2 (51-100 kg)	0	-	0	-	Grade 1	Grade 1
124 G01	-	Grade 5 (50 000 cycles)	Grade 2 (51-100 kg)	0	-	0	-	Grade 1	Grade 1

Stand

ÜRÜN TEŞHİR STANDLARI • PRODUCT DISPLAY STANDS

■ 190-0032 • DUVAR TİPİ BÜYÜK STAND • WALL MOUNT STAND



■ Teknik Detay / Technical Detail

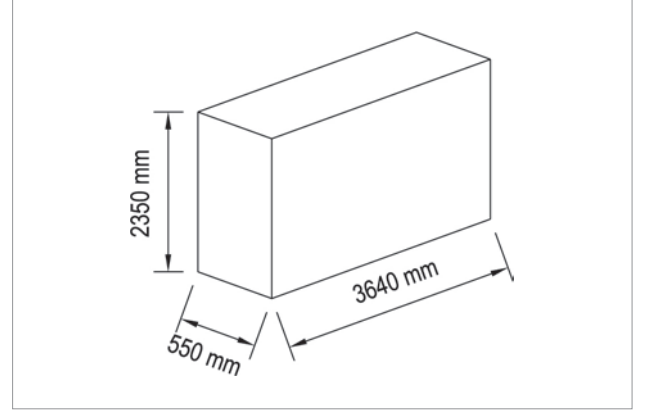

■ 190-0027 • PRATİK STAND • PRACTICAL STAND



■ Teknik Detay / Technical Detail

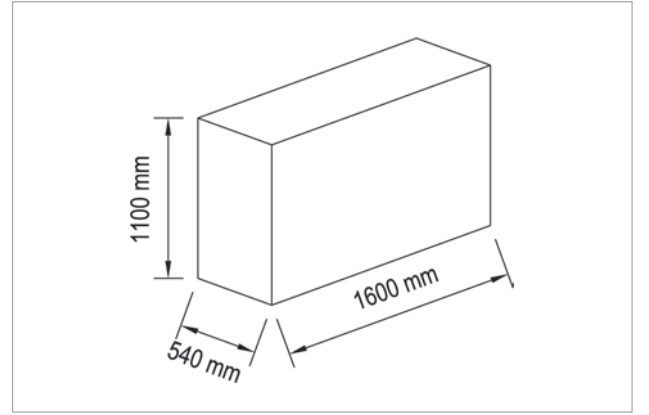

■ 190-0035 • ÜRÜN STAND • PRODUCT STAND



■ Teknik Detay / Technical Detail

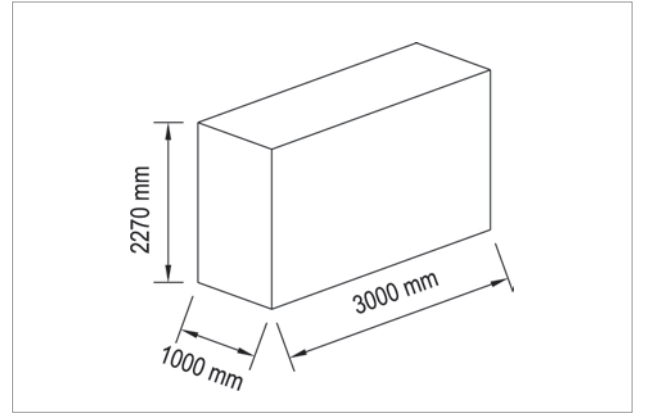

■ 190-0200 • DUVAR TİPİ BÜYÜK STAND • WALL MOUNT STAND



■ Teknik Detay / Technical Detail

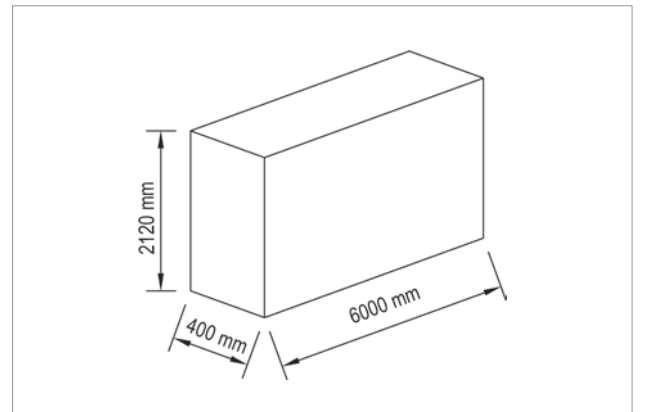

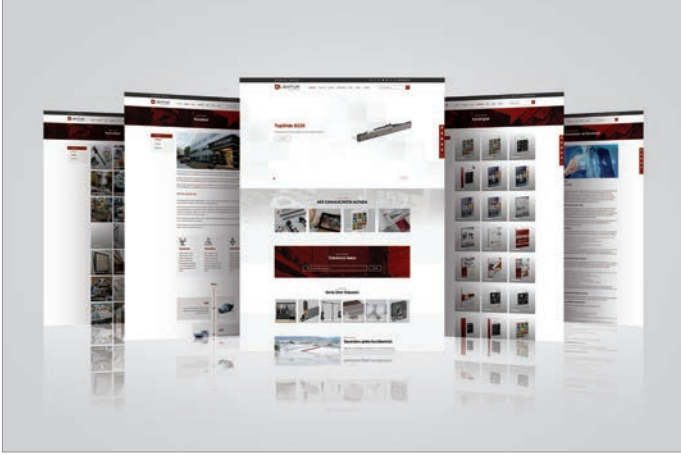

Sürekli güncellenen web sitemizde, ürünlerimizle ilgili ayrıntılı teknik bilgilere ulaşabilir, ürünlerimizin montaj videolarını izleyebilirsiniz. Ürün broşürümüzü inceleyebilir, güncel yeni ürün ve haberleri takip edebilirsiniz.

In our constantly updated website, you can reach more detailed technical information and you can watch installations videos of our products. You can see our product brochure and you can follow new products and news.

■ albaturas.com

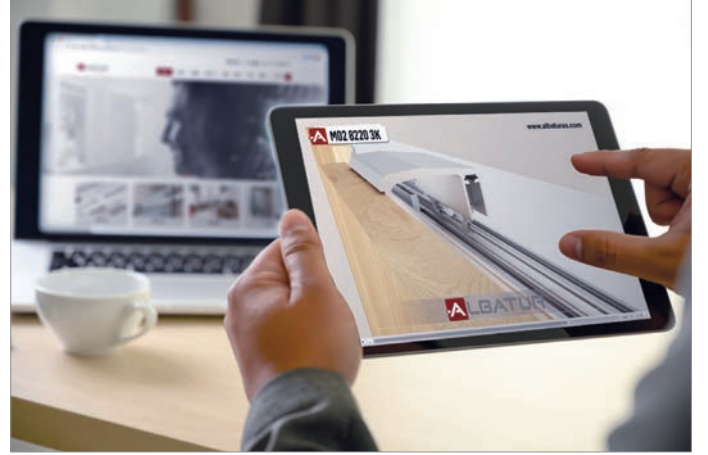

Ürünlerimizin kolay ve rahat kurulumunu sağlayabilmek için Albatur olarak montaj videoları hazırlıyoruz. Bu sayede dünyanın farklı köşelerindeki uygulayıcı profesyonellerimize ürünümüzü daha hızlı ve etkin bir şekilde tanıtmaya imkanı elde ediyoruz.

3D montaj videolarımıza
www.albaturas.com
www.youtube.com/albaturas,
vimeo.com/albaturas,
facebook sayfamızdan ulaşabilirsiniz.

In order to provide easy and pratic installation of our products, Albatur company prepares installation videos.In this way, we have the opportunity to introduce our product to our application professionals in different corners of the world faster and more effectively.

You can reach our 3D montage videos from our website
www.albaturas.com
www.youtube.com/albaturas,
vimeo.com/albaturas,
facebook page.

■ youtube.com/albaturas



Anlaşmalı Kredi Kartları

CREDIT CARD



Kredi kartı taksit sayıları anlaşmalı bankalar ile her ayın ilk iş günü güncellenmektedir.

Kredi kartı işlemleri için tahsilat.albaturas.com

Tüm kredi kartı tahsilat işlemleri 3D Security şifreli olarak gerçekleşmektedir.

Banka Bilgileri

BANK INFORMATION

Banka	YAPI KREDİ BANKASI
Şube Kodu	935
Şube Adı	BURSA / ATA BULVARI
Hesap No	856 56 013
Hesap Adı	ALBATUR ENDÜSTRİ AŞ.
IBAN	TR88 0006 7010 0000 0085 6560 13
Döviz	TL

Doğrudan Borçlandırma Sistemi - DBS

CREDIT SYSTEM



DBS işlemleri için anlaşmalı bankalarımız ile iletişime geçebilirsiniz.
Farklı banka tercihleriniz için müşteri temsilcilerimizden destek alabilirsiniz.
DBS faturalarında maksimum vademiz 90 gündür.

For DBS transactions, you can contact our partner banks.
For different bank preferences, you can receive support from our customer representatives.
The maximum term for DBS invoices is 90 days.

Önemli Notlar

IMPORTANT NOTES

1. Sürgü Sistem mekanizmaları ve üretimini gerçekleştirdiğimiz tüm Albatür markalı ürünler sistem bileşenleri ile birlikte tasarlanmaktadır. Ürünlerimizde müşteri memnuniyetinin üst seviyede karşılanması için, sürgü sistem ve diğer üretimini gerçekleştirdiğimiz ürünlerin set halinde ALBATÜR markalı olarak kullanılmasını tavsiye ederiz.
2. Sistem elemanlarının "Muadil" ürünler kullanılarak montajlanması durumunda karşılaşılabilecek sorunlardan firmamız sorumlu değildir.
3. Sürgü sistemlerinde her kapak için belirlenmiş taşıma ağırlıklarının aşılmaması önemlidir. Sistemin taşıma ağırlığından fazla yük yüklenmesi sürgü sisteminize zarar verebilir.
4. Sürme sistemlerin stabil çalışması ve ürünlerinizin uzun ömürlü kullanımı için dolabınızın terazide olması önemlidir. Sürgü sistemler hassas ölçülerde çalışmaktadır. Kurulum esnasında bu konuda hassasiyet gösterilmesini tavsiye ederiz.
5. Dolaplarınızın üretimi ve montajı esnasında sürgü sistem teker gruplarının darbeye maruz kalmaması çok önemlidir. Aksi halde teker yüzeyinde veya ray profilleri üzerindeki deformasyonlar kullanıcı memnuniyetini azaltabilir.
6. Teker sistemi ray profiline takılmadan önce, çapak ve benzeri yüzey kirlerinin temizlenmesi ve silinerek montaj edilmesi tavsiye edilir. Aksi durumda mekanizma üzerindeki yabancı malzemeler ray profil yüzeyine zarar verebilir.
7. Ray profillerinin kanal aralarına girebilecek toz vs yabancı cisimler elektrikli süpürge yardımıyla veya kuru bez ile temizlenmesi tavsiye edilir. Temizlenmemesi durumunda bu kalıntılar tekerlek yüzeyine zarar verebilir.
8. Sürgü sistemlerinde en sık karşılaşılan çalışma problemi, firmamıza ait ürünün hatalı olmasından kaynaklanmayan kapaklarda kullanılan doğal ahşap malzemelerin evsafından ve dış etkenlerden kaynaklı olarak değişim göstermesi ve kapakların birbirine temas etmesidir. Bu türden problemleri en başından engellemek için sürme kapaklarınızda kapak gergi sistemleri kullanmanızı tavsiye ederiz.
9. Yavaşlatıcı mekanizmalar ve entegre çalışan yavaşlatıcı sürgü sistem mekanizmalarının oda sıcaklığında muhafaza edilmesi tavsiye edilir. Piston gövdelerinin aşırı soğuk veya sıcakta maruz kalması ürün performansını olumsuz etkiler.
10. Ürünlerimizin montajında, Yavaşlatıcı sistemlerin montaj öncesinde kurulması önemle tavsiye edilir. Kurulmadan montaj edilmesi durumunda yavaşlatıcıların aktivatör yakalama dili zarar görebilir. Bu sebepten montaj esnasında zarar gören ürünler garanti kapsamı dışındadır.
11. Sürme sistemlerinde harici ve entegre olarak kullanılan yavaşlatıcı mekanizmaların montaj talimatına uygun gerçekleştirilen aktivatör montajı, sistemin sağlıklı ve sorunsuz çalışması için önemlidir. Web sitemizde bulunan teknik dokümanlarımızdan ve ürün kurulum videolarımızdan, tercih ettiğiniz Albatür markalı ürünler için destek alabilirsiniz.
12. Metal TV altlıklarında ürünün taşıma kapasitesinin üzerinde yük yüklenmemesi gerekmektedir. Fazla yük ürünün çalışma prensibine zarar verebilir.
13. Tüm ürünlerimizde montaj talimatına mutlaka uyulması gerekmektedir.
14. Ürünlerimizin montajı esnasında uygulanan yanlış yöntemlerden dolayı yaşanacak hatalardan firmamız sorumlu değildir. Ürünlerimizin kurulumu esnasında dikkat edilmesi gereken hususlar web sitemizde bulunan teknik doküman ve videolarda mevcuttur. Kurulumu başlamadan önce ürüne ait video ve dokümanları incelemenizi tavsiye ederiz.
15. Müşteri tarafından talep edilen ve Albatür tarafından özel üretim yapılan ürünler (üretim hatalı olması dışında) iade alınmaz.
16. Ürünlerimizle ilgili yedek parça taleplerinde kalite yönetim sistemimiz gereğince, üründe hata varsa tespit edebilmek ve kalıcı aksiyon alabilmek adına parçaların firmamıza ulaştırılması gerekmektedir. Aksi durumda yeni parçalar fatura edilerek sevk edilir.
17. Ürünlerimizin demontaj yapılarak kullanılması durumunda yaşanabilecek problemlerden firmamız sorumlu değildir.
18. Ürünlerimiz iç mekan yaşam alanları için tasarlandığından bu ortamlarda kullanılması tavsiye edilir. Dış mekanlarda kullanılacak ürünler için satış ekiplerimizle temasa geçebilir ve teknik bilgi talep edebilirsiniz.
19. Albatür ürünleri, sadece önceden boyanmış, boyası tamamen kurumuş zemin ve ortamlarda montaj edilmelidir. Ayrıca önemle bilinmelidir ki; bazı kimyasal temizlik malzemelerinin kullanımı (deterjan, asit, alkol ve çözücüler vb ..) yüzey kaplamalarına ve mekanizmaya zarar verebileceği için kesinlikle tavsiye edilmez.
20. Albatür gerekli gördüğü zamanda ve durumda, önceden haber vermeksizin ürünlerde ölçü, renk, şekil değişikliği yapma hatta modeli tamamen üretimden kaldırma hakkına sahiptir.
21. Bu kataloğun tüm çoğaltma hakları Albatür Endüstri A.Ş.'ne aittir. İzinsiz çoğaltılamaz.
22. Baskıdan kaynaklanan hatalardan Albatür Endüstri A.Ş. sorumlu değildir.
23. Resimler örnek görüntüler olabilir ve/veya teslim edilecek ürün görselinden farklı bir görünüme sahip olabilir.
24. Kataloğumuzda ve web sayfamızda verilen teknik tanımlar, ölçüler ve çizimler bağlayıcı değildir. Önerilen kurulum ölçüleridir. Albatür ürün özelliklerinde haber vermeden değişiklik yapılabilir.
25. Ürünlerimiz hakkında ürün detaylarına ve teknik çizimlere www.albaturas.com daki ürün sayfalarımızdan ulaşabilirsiniz.
26. Katalog sayfalarımızdaki qr-code 'ları akıllı cihazlar ile tarayabilir ve web üzerindeki ürün sayfasına, teknik çizimlere ve videolara ulaşabilirsiniz.

Important Notes

ÖNEMLİ NOTLAR

1. Sliding System mechanisms and all Albatur branded products that we produce are designed together with system components. For the keep customer satisfaction at the highest level in our products, we recommend that the sliding system and other products what we manufacturing be used as a set with Albatur brand
2. If the system fittings are assembled using «equivalent» products, our company is not responsible for the problems that may occur in this case
3. In sliding systems, it is important not to overlap the specified carrying weights for each door. Loading more than the carrying weight on the system can be damage your sliding system.
4. For the stable and well working of your sliding systems; its important to make good balance of your wardrobe. Sliding systems are working with sensitive dimensions. We recommend paying attention to this issue during installation.
5. It is very important that the sliding system wheels group are not exposed to impact during the production and installation of your cabinets. Otherwise, deformations on the wheels surface or rail profiles can decrease user satisfaction.
6. Before the assembly the wheels system on the rails, recommended to clean the burrs and dirt from the surface. Otherwise other foreign materials can be damage on the profile surface
7. It is recommended to clean rail profiles with a vacuum cleaner or duster for dust etc. objects that may get into between the channels. If not cleaned well, the residues may damage your wheels surface.
8. The most common working problem in sliding systems is that the natural wood materials used in the covers, which are not caused by the faulty product of our company, change due to the quality and external factors, and the covers come into touch with each other. In order to prevent such problems from the beginning, we recommend using door tensioning systems in your sliding doors.
9. It is recommended to keep all kind of the soft closer system mechanisms at room temperature. If leaving the pistons in extreme heat or cold condition ,will be decrease product performance.
10. In the installation of our products, highly recommended to assembly the soft closers before system installation.Soft closers activator's kit can be damage If the install before the assembly. For this reason, damaged products during assembly are out of warranty.
11. Activator installation performed in accordance with the installation instructions of soft closer mechanisms used externally and integrally in sliding systems is important for healthy and trouble-free use of the system. You can get support for your preferred Albatur branded products from our technical prospectus and product installation videos on our website.
12. In the Metal Tv turnable system , should not be load more than carrying capacity. Overload can be damage working principle of the products.
13. Installation instructions must be followed in all our products.
14. Our company is not responsible for the mistakes that may occur due to the wrong methods application during the assembly of our products. Technical documents and related product assembly videos are available in on our website regarding the points that considered during the installation of our products.
15. Special products produced by Albatur with customer request are not returned.(Except for a production faulty)
16. In accordance with our quality management system for the spare part requests related to our products, the fault parts must be delivered to our company in order to detect if there is a fault in the product and for take permanent action.
17. Our company is not responsible for the problems will be happening if our products are used by disassembly.
18. Our products are designed for indoor living spaces, so its recommended to be used in these areas. Products to use for outdoors, you can contact our sales teams and request technical information.
19. Albatur products should only be installed on pre-painted or completely dried floors and environments. It should be known that; the use of some chemical cleaning materials (detergents, acid, alcohol and solvents etc.) is absolutely not recommended as it can damage surface coatings and mechanism.
20. Albatur reserves the right to change the sizes, colors and shape of the products at any time and in case it deems necessary, or even to remove the model completely from the production.
21. All reproduce of this catalog rights are reserved by Albatur Industry Inc. It can't be reproduced without permission.
22. Albatur Industry Inc. is not responsible for printing mistakes.
23. Pictures are can be sample images and/or may will be differnet view the product from the picture of to be delivered.
24. Technical definitions, dimensions and drawings given in our catalog and on our website are not binding. its recommended installation dimensions. Albatur can make changes in the products specifications without notice.
25. You can reach to detailed information about our products and technical drawings of our products on our website www.albaturas.com
26. You can scan the qr-codes in our catalog pages with your smart devices and access the product page, technical drawings and videos on the website.

Kapak Ağırlığı Hesaplama Tablosu

DOOR WEIGHT CALCULATION TABLE

■ Mdf / Mdf



(mm)	(kg/m ²)
4	3,2
6	4,8
8	6,6
10	8,0
16	11,4
18	14,5
22	17,9
25	20,2
30	23,0
35	28,2
40	32,4

■ Sunta / Chipboard



(mm)	(kg/m ²)
8	5,5
16	10,0
18	11,2
22	13,6
25	15,3
30	18,1
35	22,0
40	25,0

■ Cam / Glass



(mm)	(kg/m ²)
4	10,0
5	12,5
6	15,0
8	20,0
10	25,0
12	30,5

Bu sayfanın içeriği sadece referans içindir.
The content of this page is for reference only.

B2B

BUSINESS TO BUSINESS

ALBATUR[®]
produces quality

ALB[®]

ALB GLOBAL[®]

Dormech[®]
door automation

Québec[®]

windustop[®]

SRG[®]

SETBOX[®]

**The
Sliding
System**

(R)

TurnTable[®]

Pulltens[®]

Multiline[®]

WingSlide[®]

GlassDoor[®]

MultiDoor[®]

BarnDoor[®]

Glassline[®]

DoorSlide[®]

TvSlide[®]

Rigel[®]

Coplanar[®]

Softline[®]

DoorSync[®]

Underline[®]

TopSlide[®]

MasterFold[®]

MagicLift[®]

HINGETECH[®]
Hinge Technology

Ventil[®]Plastic

Ventil[®]Aluminium

Momentum[®]

Interline[®]

Domino[®]

Feet[®]

Master+[®]

link+

